

PRODUCT CATALOGUE

**Pyplok™**

Non-Welded Mechanically  
Attached Fittings

# Table of Contents

## Introduction

Notice .....	A1
What is PYPLOK® .....	A2
Technology .....	A3
PYPLOK® System Benefits .....	A5
Industries and Applications .....	A6

## Technical Information

Tube and Pipe Qualification .....	B1
Tube and Pipe Qualification: CUSTOM Material .....	B2
PYPLOK® Pressure Ratings	
DM 20 Series – NPS Pipe .....	B3
DM 60 Series – OD Tube .....	B5
DM 80 Series – Metric Tube .....	B7
DM 80 Series – JIS Metric Tube .....	B8
DP 40 Series – NPS Low Pressure .....	B9
DP 04 Series – Metric Pipe CuNi .....	B9
Seal Selection .....	B10
Thread Size Charts .....	B11

## DM 20 Series - NPS Pipe

General Characteristics .....	C1
Standard Fitting Configuration Guide .....	C2
Coupling, NPS - DM20001 .....	C3
Coupling with Inner Stop, NPS - DM20002 .....	C3
90° Elbow, NPS - DM20003 .....	C4
45° Elbow, NPS - DM20017 .....	C4
Tee, NPS - DM20004 .....	C5
Reducing Tee, NPS - DM20104 .....	C5
Reducer, NPS - DM20101 .....	C6
End Cap, NPS - DM20085 .....	C6
Flange – ANSI 150#, NPS - DM20018 .....	C7
Flange – ANSI 300#, NPS - DM20019 .....	C7
Flange – ANSI 600#, NPS - DM20027 .....	C8
SAE Flange Body, NPS - DM20090 .....	C8
SAE Code 61 Flange, NPS - DM20091 .....	C9
SAE Code 62 Flange, NPS - DM20092 .....	C9
SAE Code 61 Tapped Flange, NPS - DM20095 .....	C10
SAE Code 62 Tapped Flange, NPS - DM20096 .....	C10
JIC 37° Male, NPS - DM20055 .....	C11
JIC 37° Female Swivel, NPS - DM20054 .....	C11
NPT Male, NPS - DM20056 .....	C12
NPT Female, NPS - DM20060 .....	C12
SAE Male, NPS - DM20088 .....	C13
SAE Female, NPS - DM20087 .....	C13
BSPP Male, NPS - DM20153 .....	C14
BSPP Female, NPS - DM20086 .....	C14
ORFS Male, NPS - DM20010 .....	C15
ORFS Female Swivel, NPS - DM20020 .....	C15
Weldable Bulkhead, OD Tube - DM60089 .....	C16
SAE Female Branch Tee, NPS - DM20171 .....	C16
BSPP Female Branch Tee, NPS - DM20172 .....	C17
NPT Female Branch Tee, NPS - DM20173 .....	C17
Specialty Fitting Configuration Guide .....	C18

# Table of Contents

## DM 60 Series - OD Tube

General Characteristics .....	D1
Standard Fitting Configuration Guide .....	D2
Coupling, OD Tube - DM60001 .....	D3
Coupling with Inner Stop, OD Tube - DM60002 .....	D3
90° Elbow, OD Tube - DM60003 .....	D4
45° Elbow, OD Tube - DM60017 .....	D4
Tee, OD Tube - DM60004 .....	D5
Reducing Tee, OD Tube - DM60104 .....	D6
Reducer, OD Tube - DM60101 .....	D7
End Cap, OD Tube - DM60085 .....	D8
Flange – ANSI 150#, OD Tube - DM60018 .....	D9
Flange – ANSI 300#, OD Tube - DM60019 .....	D9
Flange – ANSI 600#, OD Tube - DM60027 .....	D10
SAE Flange Body, OD Tube - DM60090 .....	D10
SAE Code 61 Flange, OD Tube - DM60091 .....	D11
SAE Code 62 Flange, OD Tube - DM60092 .....	D11
SAE Code 61 Tapped Flange, OD Tube - DM60095 .....	D12
SAE Code 62 Tapped Flange, OD Tube - DM60096 .....	D12
JIC 37° Male, OD Tube - DM60055 .....	D13
JIC 37° Female Swivel, OD Tube - DM60054 .....	D13
NPT Male, OD Tube - DM60056 .....	D14
NPT Female, OD Tube - DM60060 .....	D14
SAE Male, OD Tube - DM60088 .....	D15
SAE Female, OD Tube - DM60087 .....	D15
BSPP Male, OD Tube - DM60153 .....	D16
BSPP Female, OD Tube - DM60086 .....	D16
ORFS Male, OD Tube - DM60010 .....	D17
ORFS Female Swivel, OD Tube - DM60020 .....	D17
Weldable Bulkhead, OD Tube - DM60089 .....	D18
SAE Female Branch Tee, OD Tube - DM60171 .....	D18
BSPP Female Branch Tee, OD Tube - DM60172 .....	D19
NPT Female Branch Tee, OD Tube - DM60173 .....	D19
Specialty Fitting Configuration Guide .....	D20

## DM 80 Series - Metric Tube

General Characteristics .....	E1
Standard Fitting Configuration Guide .....	E2
Coupling, Metric - DM80001 .....	E3
Coupling with Inner Stop, Metric - DM80002 .....	E4
90° Elbow, Metric - DM80003 .....	E5
45° Elbow, Metric - DM80017 .....	E6
Tee, Metric - DM80004 .....	E7
Reducing Tee, Metric - DM80104 .....	E8
Reducer, Metric - DM80101 .....	E9
End Cap, Metric - DM80085 .....	E10
Flange – PN16, Metric - DM80028 .....	E11
Flange – PN40, Metric - DM80029 .....	E11
SAE Flange Body, Metric - DM80090 .....	E12
ISO 6162-1 Flange, Metric - DM80091 .....	E13
ISO 6162-2 Flange, Metric - DM80092 .....	E13
ISO 6162-1 Tapped Flange, Metric - DM80095 .....	E14
ISO 6162-2 Tapped Flange, Metric - DM80096 .....	E14
JIC 37° Male, Metric - DM80055 .....	E15
JIC 37° Female Swivel, Metric - DM80054 .....	E15
BSPP Male, Metric - DM80153 .....	E16
BSPP Female, Metric - DM80086 .....	E17
DIN 24° Male, Metric - DM80066 .....	E18
DIN 24° Female Swivel, Metric - DM80068 .....	E19
Weldable Bulkhead, Metric - DM80089 .....	E20
BSPP Female Branch Tee, Metric - DM80172 .....	E21
BSPP Female Branch Tee, Metric – DM80211 .....	E22

# Table of Contents

## DM 80 Series - Metric Tube, cont'd

BSPP (2) Port Female Branch Cross, Metric – DM80221 .....	E23
BSPP (4) Port Female Branch Cross, Metric – BM80241 .....	E24
Speciality Fitting Configuration Guide .....	E26

## DM Series Thread Adapter

General Characteristics .....	F1
Standard Fitting Configuration Guide .....	F2
BSPP Male to ORFS Male Adapter DM81060 & BSPP Male to JIC Male Adapter DM81061 .....	F3
BSPP Male to DIN Male Adapter DM81062 & BSPP Male to JIC Male Adapter DM81064 .....	F4
BSPP Male to DIN Male Adapter DM81063 & BSPP Male to DIN Male Adapter DM81065 .....	F5
BSPP Male to ORFS Male Adapter DM81066 & BSPP Male to DIN Female Swivel Adapter DM81067 ...	F6

## DM 80 Series - JIS Metric Tube

General Characteristics .....	G1
Standard Fitting Configuration Guide .....	G2
Coupling, Metric, JIS - DM80001 .....	G3
Coupling with Inner Stop, Metric, JIS - DM80002 .....	G4
90° Elbow, Metric, JIS - DM80003 .....	G5
45° Elbow, Metric, JIS - DM80017 .....	G6
Tee, Metric, JIS - DM80004 .....	G7
End Cap, Metric, JIS - DM80085.....	G8
Specialty Fitting Configuration Guide .....	G9

## DP 40N Series - NPS Low Pressure

General Characteristics .....	H1
Standard Fitting Configuration Guide .....	H2
Low Pressure Coupling, NPS - DP40N100 .....	H3
Low Pressure 90° Elbow, NPS - DP40N300 .....	H3
Low Pressure 45° Elbow, NPS - DP40N017 .....	H4
Low Pressure Tee, NPS - DP40N400.....	H4
Low Pressure Reducing Tee, NPS - DP40N104 .....	H5
Low Pressure Reducer, NPS - DP40N101 .....	H5
Low Pressure End Cap, NPS - DP40N085.....	H6
Low Pressure Flange – ANSI 150#, NPS - DP40N018 .....	H6
Low Pressure SAE Code 61 Flange, NPS - DP40N091 .....	H7
Low Pressure SAE Code 61 Tapped Flange, NPS - DP40N095.....	H7

## DP 40M Series - Metric Low Pressure

General Characteristics .....	I1
Standard Fitting Configuration Guide .....	I2
Coupling, Metric - DP40M100 .....	I3
90° Elbow, Metric - DP40M300 .....	I3
45° Elbow, Metric - DP40M017 .....	I4
Tee, Metric - DP40M400.....	I4
End Cap, Metric - DP40M085.....	I5
Flange – ANSI #150, Metric - DP40M018 .....	I5

# Table of Contents

## PYPLOK® Tooling

The PYPLOK® Swaging Tooling System.....	J1
PYPLOK® Tooling Dimensions	
Model 10.....	J2
Model 20.....	J2
Model 40.....	J3
Model 55.....	J3
Model 70.....	J4
Model 86.....	J4
PYPLOK® Tooling Size Range Coverage.....	J5
PYPLOK® Tool Matrix	
DM 20 Series - NPS Pipe.....	J6
DM 60 Series - OD Tube.....	J7
DM 80 Series - Metric Tube.....	J8
DP 40N Series - NPS Low Pressure and DP 40M Series - Metric Low Pressure.....	J10
PYPLOK® Swaging Tool Pump Requirements.....	J11
Pumps Offered by Tube-Mac® for Use with the PYPLOK® Tooling.....	J11
PYPLOK® Tooling Accessories.....	J12

## Installation Procedures

PYPLOK® Swaging Tool Parts and Equipment.....	K1
Pipe Preparation.....	K2
Pipe Preparation - Special Notice.....	K3
Verify Diameter of the Pipe Using the Inspection Gauge.....	K4
Pipe Marking.....	K4
Coupling Position and Alignment.....	K5
Swage Sequence.....	K6
Tool Operation and Die Engagement.....	K7
Swage Inspection and Assembly.....	K8
Swage and Installation Inspection.....	K9

## Appendix

PYPLOK® Limited Warranty.....	L1
-------------------------------	----

# Introduction

## Notice

The information and data presented in this catalogue is intended as reference for use of PYPLOK® equipment by designers and users for proper application and installation of the product. It is not intended to be used as a substitute for competent, professional assistance for any specific application.

While every effort has been made to ensure its accuracy, Tube-Mac®, its subsidiaries and affiliated companies, make no express or implied warranty of any kind regarding the information contained in this catalogue or the material referred within.

The technical and performance information such as weights, dimensions and ratings in this catalogue supersede all previous published data. Tube-Mac® is always striving for continual product improvement and developments and therefore reserves the right to change product designs, specifications and limitations without notice.

Anyone making use of the information or material contained herein does so at their own risk and assumes any and all liability resulting from such use.

All technical data presented should always be used to design a system along with good piping practices. The pressure, temperature and other limiting factors of the PYPLOK® product must never be exceeded. For any additional technical information, it is recommended to contact Tube-Mac®.

The logo for Pyplok™ features the word "Pyplok" in a bold, dark blue sans-serif font. The letter "o" is replaced by a green circular icon consisting of multiple radial segments, resembling a gear or a sunburst. A small "TM" trademark symbol is positioned to the upper right of the "k".

Introduction

Technical Information

DM 20 – NPS Pipe

DM 60 – OD Tube

DM 80 – Metric Tube

DM Series Thread Adapter

DM80 – Metric JIS Tube

DP 40N – NPS Low Pressure

DP 40M – Metric Low Pressure

PYPLOK® Tooling

Installation Procedures

Appendix

A1

# Introduction

## What is PYPLOK®

PYPLOK® is a 360° radial swage mechanically attached fitting which permanently connects pipe and tube for a leak free, cold connection. The system is fast, reliable and tamper proof ideal for use in new build and maintenance works where fire hazards exist and a clean piping connection is required. A hydraulically powered compression tool swages the fitting over pipe/tube plastically deforming the fitting in seconds. The fitting can be used in a wide variety of low to high pressure piping applications in industries such as Marine & Offshore, Navy, Oil & Gas, Petrochemical, Steel, Mining and other Industrial uses.



This technology was originally developed in 1968 by McDonnell Aircraft as a replacement to threaded and brazed joints on the F-4 Fighter Jet. Threaded and brazed joints were less reliable in applications of high stresses and loads so they developed the 360° Radial Swage technology. McDonnell Aircraft licensed a company, Deutsch Metal Components (DMC) to manufacture this new fitting technology specifically for aerospace tubing application. In 1978, DMC expanded the range of the product to Nominal Bore Pipe, OD Tube and Metric Tube for industrial applications in the Oil & Gas, Marine & Offshore, Navy and Industrial Process and Power Piping industries. As an equal or better equivalent to welding and threading it was accepted as a new alternative to connecting pipes and tubes.

In 2007, DMC decided to divest in the industrial line of Mechanically Attached Fittings and sell the product line to one of its largest users which was Tube-Mac®. Since then Tube-Mac® has integrated PYPLOK® into their large offering of non-welded piping solutions and has expanded the range to additional materials, configurations and sizes.

# Introduction

## Technology

PYPLOK® Fittings incorporates a unique sealing capability by using four non-metallic O-Rings which compress against the pipe surface which produces a leak tight, permanent seal. Due to the use of O-Rings, the fitting is able to be installed on normal pipe and tube tolerances and surface conditions.

The PYPLOK® connector is a metal sleeve which slides over the pipe or tube. The outer diameter at each end of the connector is then swaged against the pipe or tube using a hand held portable hydraulic tool. The tool transfers a linear force of 360° radial force which results in a permanent leak free connection. At each swaged end there is an internal helical ridge which, when swaged, penetrates the outer surface of the pipe or tube. Axial grooves separate the ridge into teeth which resist torsional loads.

There are two O-Ring seals. The “Inner Main Seal” is the high pressure seal. The O-Ring groove which houses this main seal has an annular ridge directly beside the groove which provides additional support upon swaging assuring a fluid tight connection. At the outer end of the fitting is the second O-Ring groove which houses the “Outer Environmental Seal”. This seal prevents the ingress of fluids and/or contaminants from entering between the fitting and the tube thereby preventing internal corrosion.

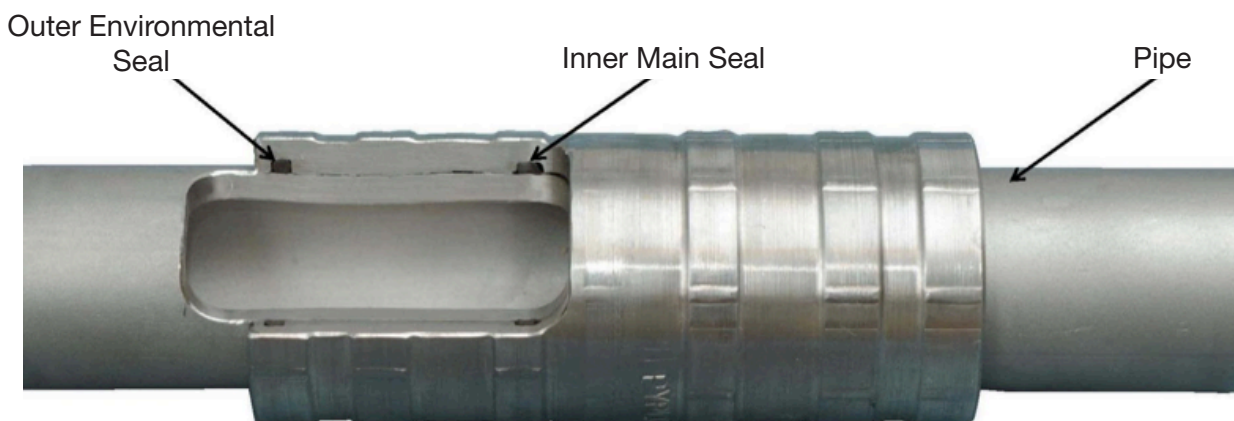

PYPLOK® has been mechanically and environmentally tested according to many standards and procedures over the years. PYPLOK® has passed combined impulse and vibration tests as well as shock and fire tests. PYPLOK® was analyzed using FEA (Finite Element Analysis) to ensure compliance under ASME B31.1, 31.3, 31.4 & 31.8. Below are some of the type approvals and standards to which PYPLOK® complies:

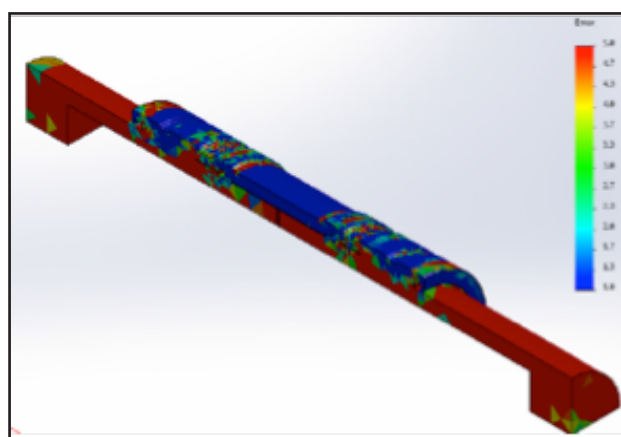
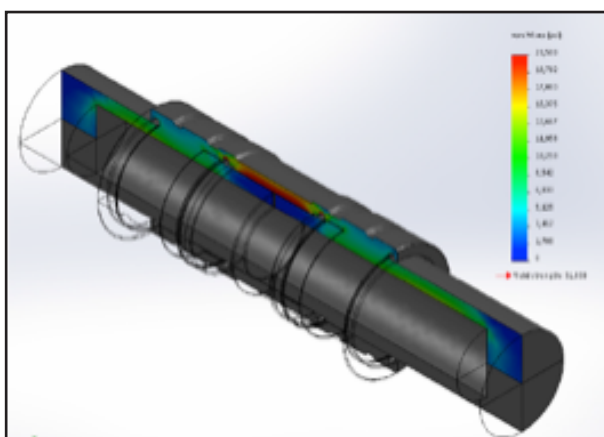



# Introduction



ASME B31.1, 31.3, 31.4 & 31.8 Qualified

CRN – Canadian Registration No. 0A12153.5

API 6FB and ISO 19921/15540 Fire Test

NAVSEA and USCG Approved

ABS, DNV, Lloyd's, CCS, RMRS & BV Type Approved

The installation and subsequent inspection of fittings is the most expensive part of joining and maintaining any piping system. Regardless of the type of piping system, there may be numerous threaded, welded and brazed fittings. These traditional types of fittings are costly to install as they are more labour intensive.

Expensive and laborious procedures may include the following:

- Obtaining permits
- Inspection of joint
- Rework of joints that do not pass inspection
- Preparation time
- Hydrostatic testing
- Time for welding or brazing
- Fit-up time
- Purging the system
- Need for a fire watch

PYPLOK® Mechanically Attached Fitting System is the best alternative to threaded, welded, or brazed joints.

Some of the many advantages of using PYPLOK® over traditional methods are:

- There is no need to purge or flush the piping system of gas or liquid because the application of PYPLOK® requires no hot work. In other words, PYPLOK® is installed cold.
- The time required to join the pipe ends together is significantly shorter because of the portable tools used to compress the fitting onto the pipe.
- Reduced inspection time through an inspection gauge, which checks for proper swaged diameter to determine satisfactory compression of the fitting. This eliminates the need for conventional NDT requirements such as X-rays etc.
- There is no need for fire watch or any special fire permit which are needed for welding or brazing, as there are no fumes or fire hazards when installing PYPLOK®.
- PYPLOK® is a safe cold work technology.

With all the advantages listed above, PYPLOK® is certainly the most economical and efficient way of joining pipes. It dramatically reduces costs, greatly enhances quality and significantly improves safety conditions and reliability of the completed joint.

# Introduction

PYPLOK® fittings come in all standard configurations (straights, 45° & 90° elbows, adapter, tees, reducers and flanged ends).

PYPLOK® configurations provide permanent ends or a combination of permanent and separable ends. Separable ends include ANSI, SAE and ISO Flanged as well as JIC 37°, ORFS, NPT, BSPP and DIN 24° fittings.

PYPLOK® fittings are available in Carbon Steel, Stainless Steel and Copper Nickel (CuNi), Duplex and Super Duplex.

PYPLOK® is suitable for NPS pipes, OD tubes and Metric tubes.

## PYPLOK® System Benefits

**PYPLOK® system assists you and your team with safe and cost effective work practices**

### Most cost effective on-site pipe work fabrication and repairs

- Reduces on-site time and labour; PYPLOK® fittings are swaged on cold, hot work permits are no longer required. PYPLOK® tooling is hydraulically actuated removing the need for special site services.
- PYPLOK® system prevents the need for Gas Freeing, System Flushing, NDT, and Fire Watch; designed as a one person operation.
- Swaged fittings are verified with an inspection gauge - much quicker than NDT.

### Provides an improved safety environment

- The PYPLOK® system, developed to reduce hot work, is in itself a safe system. There are no torches, open flames or sparks associated with the installation or maintenance.

### PYPLOK® system on EVERY installation achieves

- Improved productivity; many tasks carried out in only one-shift with minimum disruption to production.
- Installed cost reduction of up to 60%.

### PYPLOK® system on EVERY installation offers

- High tensile and high torque hold.
- Minimum pipe preparation.

### Requires very little specialized skill and training

- PYPLOK® system provides a range of fittings and hand-held tooling that requires a minimum of specialized skills to install - easy and user friendly.
- Training takes less than 30-minutes to complete.
- Fully detailed, simple to follow documentation (Installation and Preventative Maintenance Manuals including Inspection Criteria Instructions) are provided with each purchased kit.

### How much does it cost - rent or buy?

- Clients have recuperated tooling and fitting costs in one system installation.
- Tooling Rental Program and or Purchase Programs Available.

# Introduction

## Industries and Applications

**PYPLOK® has been used in numerous industries worldwide including but not limited to:**

- Ship Building and Repair (Commercial and Navy)
- Refinery, Chemical, Pharmaceuticals, Food/Beverage
- Marine, Offshore and Sub Sea
- Land Based Drilling Rigs, Mobile Equipment
- Sugar, Steel/Metal Production, Testing Equipment, Fire Suppression
- Mining, Pulp and Paper, Nuclear/Power Generation, Automotive

**PYPLOK® Applications Include:**

- CNG – Compressed Natural Gas
- CO2 Cofferdam Inerting
- Condensate Piping
- Deluge Systems
- Down Well Coiled Tubing
- Drains and Plumbing Vent
- Ethylene Glycol/Water
- Fuel and Fuel Heating Lines
- Heating Coils
- Utility Piping Systems
- High Pressure Fire Suppression Systems
- Mobile Equipment Tubing/Piping
- High Pressure Hydraulics Systems
- Low Temperature Steam (<200°C)
- LPG – Liquefied Petroleum Gas
- Lubrication & Grease
- Natural Gas Distribution
- Plant, Instrumentation and Utility Air
- Waste Systems
- Solvents and Water Based Paints
- Subsea/BOP Piping
- Steam Tracer Lines
- Waste Water
- Paint, Brake Fluid and Sealer Lines

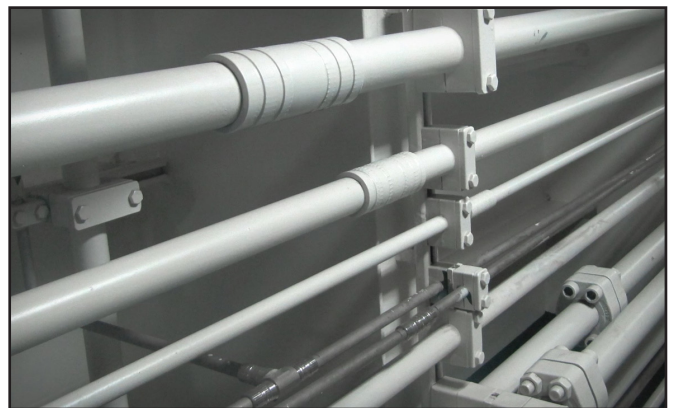
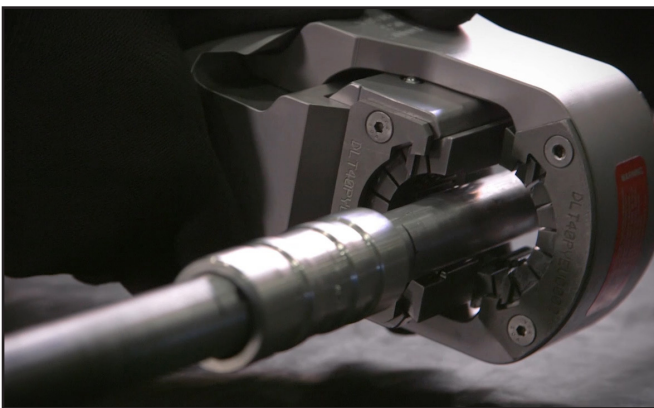





# Tube and Pipe Qualification

DM 20 Series - NPS Pipe		
Size	Min. Wall	Max. Wall
1/4"	Sch.10	Sch.80
3/8"	Sch.10	Sch.80
1/2"	Sch.10	Sch.80
3/4"	Sch.10	Sch.80
1"	Sch.10	Sch.160
1-1/4"	Sch.10	Sch.160
1-1/2"	Sch.10	Sch.160
2"	Sch.10	Sch.160
3"	Sch.80	Sch.160

DM 80 Series - JIS Metric Tube			
Size	OD	Min. Wall	Max. Wall
06A	10.50mm	1.00mm	3.00mm
08A	13.80mm	1.00mm	3.00mm
10A	17.30mm	1.00mm	3.20mm
15A	21.70mm	1.00mm	4.00mm
20A	27.20mm	2.00mm	4.00mm
25A	34.00mm	2.00mm	6.40mm
32A	42.70mm	3.00mm	6.40mm
40A	48.60mm	3.00mm	7.14mm
50A	60.50mm	3.00mm	8.71mm

DM 60 Series - OD Tube		
Size	Min. Wall	Max. Wall
1/4"	0.028"	0.083"
3/8"	0.028"	0.095"
1/2"	0.035"	0.120"
5/8"	0.035"	0.120"
3/4"	0.049"	0.180"
1"	0.049"	0.180"
1-1/4"	0.065"	0.220"
1-1/2"	0.065"	0.220"
2"	0.065"	0.220"

DP 40N Series - NPS Low Pressure		
Size	Min. Wall	Max. Wall
2-1/2"	Sch.10	Sch.80
3"	Sch.10	Sch.80
4"	Sch.10	Sch.80

DP 40M Series - Metric Pipe CuNi Tube		
Size	Min. Wall	Max. Wall
44.5mm	1mm	3mm
57mm	1mm	3mm
76mm	1mm	3mm

DM 80 Series - Metric Tube		
Size	Min. Wall	Max. Wall
6mm	1mm	2mm
8mm	1mm	2mm
10mm	1mm	3mm
12mm	1mm	3mm
15mm	1mm	3mm
16mm	1mm	3mm
18mm	1mm	3mm
20mm	1mm	4mm
22mm	1mm	4mm
25mm	2mm	4mm
28mm	2mm	4mm
30mm	2mm	4mm
35mm	2mm	4mm
38mm	3mm	5mm
42mm	3mm	5mm
50mm	3mm	5mm
60mm	3mm	8mm

Allowable Outside Pipe/Tube Diameter Tolerances for PYPLOK®		
NPS Pipe	1/4" to 1-1/2"	+/- 0.015" (0.381mm)
	2" - 4"	+/- 0.030" (0.762mm)
OD Tube	1/4" to 3/8"	+/- 0.005" (0.127mm)
	1/2" to 1-1/2"	+/- 0.010" (0.254mm)
	2"	+/- 0.015" (0.381mm)
Metric Tube	6mm to 38mm	+/- 0.254mm (0.010")
	42mm to 60mm	+/- 0.381mm (0.015")
JIS Metric Tube	06A - 25A	+/- 0.254mm (0.010")
	32A - 50A	+/- 0.381mm (0.015")

*Qualified Pipe/Tube		
Stainless Steel PYPLOK®	Carbon Steel PYPLOK®	Copper Nickel PYPLOK®
ASTM A312/A269 (304/304L/316/316L) EN 10216-5 (304/304L/316/316L) EN10305-4 (E355N/ST52.4)	ASTM A106 Gr. A/B/C A53 ERW Gr. A/B EN10305-4 (E355N/E235N/ST52.4/ST37.4) API 5L Seamless/ERW ASTM A333 Gr.6	MIL-T-16420 (70/30 & 90/10)

\*As there are numerous pipe/tube specs, not every spec has been listed. If you do not see your spec please consult the factory to confirm pipe/tube qualification.

**2" NPS DM 20 Series Carbon Steel PYPLOK® cannot be used on EN 10305-4 (E355N/ST52.4) pipe/tube but as replacement 2" NPS DM 20 Series Stainless Steel PYPLOK® or 60mm DM 80 Series Carbon Steel PYPLOK® can be used.**

# Tube and Pipe Qualification: CUSTOM Material

DM 20 Series - NPS Pipe		
Size	Min. Wall	Max. Wall
1/4"	Sch.10	Sch.80
3/8"	Sch.10	Sch.80
1/2"	Sch.10	Sch.80
3/4"	Sch.10	Sch.80
1"	Sch.10	Sch.80
1-1/4"	Sch.10	Sch.80
1-1/2"	Sch.10	Sch.80
2"	Sch.10	Sch.80

DM 60 Series - OD Tube		
Size	Min. Wall	Max. Wall
1/4"	0.028"	0.083"
3/8"	0.028"	0.095"
1/2"	0.035"	0.120"
5/8"	0.035"	0.120"
3/4"	0.049"	0.180"
1"	0.049"	0.180"
1-1/4"	0.065"	0.180"
1-1/2"	0.065"	0.180"
2"	0.065"	0.180"

DP 40N Series - NPS Low Pressure		
Size	Min. Wall	Max. Wall
2-1/2"	Sch.10	Sch.40
3"	Sch.10	Sch.40
4"	Sch.10	Sch.40

\*For certain sizes and heavier wall thickness larger tonnage PYPLOK® tooling maybe required. Consult factory for guidance on tool section with custom materials along with PYPLOK® Installation manual for special instructions.

Allowable Outside Pipe/Tube Diameter Tolerances for PYPLOK®		
NPS Pipe	1/4" to 1-1/2"	+/- 0.015" (0.381mm)
	2" - 4"	+/- 0.030" (0.762mm)
OD Tube	1/4" to 3/8"	+/- 0.005" (0.127mm)
	1/2" to 1-1/2"	+/- 0.010" (0.254mm)
	2"	+/- 0.015" (0.381mm)

*Qualified Pipe/Tube		
DUPLEX PYPLOK®	SUPER DUPLEX PYPLOK®	TITANIUM PYPLOK®
ASTM A790 (S31803/2205)	ASTM A790 (S32750/2507)	ASTM B861 Grade 2

\*As there are numerous pipes/tube specs, not every spec has been listed. If you do not see your spec please consult the factory to confirm pipe/tube qualification.

# PYPLOK® Standard Pressure Ratings

## DM 20 Series – NPS Pipe

Pressure Ratings are based on system temperatures of -15°F to 400°F (-26°C to 205°C) and are limited to the maximum rating of the adjoining tube and/or end connection. Consideration must be taken on PYPLOK® Pressure Ratings and adjoining connection with the lower rated end being the limiting factor.

Stainless Steel Pressure Ratings				
Size NPS	4:1 Safety Factor		3:1 Safety Factor	
	PSI	bar	PSI	bar
1/4"	6000	415	8000	552
3/8"	6000	415	8000	552
1/2"	5900	407	7866	543
3/4"	5800	400	7733	533
1"	5700	393	7600	524
1-1/4"	5650	390	7533	520
1-1/2"	5650	390	7533	520
2"	4800	330	6400	441
3"	2625	180	3500	240

Carbon Steel Pressure Ratings				
Size NPS	4:1 Safety Factor		3:1 Safety Factor	
	PSI	bar	PSI	bar
1/4"	5000	345	6667	460
3/8"	5000	345	6667	460
1/2"	4917	339	6555	452
3/4"	4833	333	6444	444
1"	4750	328	6333	437
1-1/4"	4710	325	6278	433
1-1/2"	4710	325	6278	433
2"	4000	276	5333	368
3"	2625	180	3500	240

\*Stainless Steel 316/316L, 2205 Duplex & 2507 Super Duplex pressure ratings

Copper Nickel Pressure Ratings				
Size NPS	4:1 Safety Factor		3:1 Safety Factor	
	PSI	bar	PSI	bar
1/4"	3896	269	5195	358
3/8"	3896	269	5195	358
1/2"	3831	264	5108	352
3/4"	3766	260	5022	346
1"	3701	255	4935	340
1-1/4"	3669	253	4892	337
1-1/2"	3669	253	4892	337
2"	3117	215	4156	287

Titanium Pressure Ratings				
Size NPS	4:1 Safety Factor		3:1 Safety Factor	
	PSI	bar	PSI	bar
1/4"	750	50	1000	70
3/8"	750	50	1000	70
1/2"	750	50	1000	70
3/4"	750	50	1000	70
1"	750	50	1000	70
1-1/4"	750	50	1000	70
1-1/2"	750	50	1000	70
2"	750	50	1000	70



# PYPLOK<sup>®</sup> Pressure Ratings According to ASME B31.1 & ASME B31.3

## DM 20 Series – NPS Pipe

Pressure Ratings are based on system temperatures that are listed below and are limited to the maximum rating of the adjoining tube and/or end connection. Consideration must be taken on PYPLOK<sup>®</sup> Pressure Ratings and adjoining connection with the lower rated end being the limiting factor.

Stainless Steel Pressure Ratings				
Size NPS	ASME B31.1 (PSI)			
	-20°F to 100°F	200°F	300°F	400°F
1/4"	5800	5800	5800	5600
3/8"	5600	5600	5600	5400
1/2"	5400	5400	5400	5200
3/4"	5100	5100	5100	5000
1"	4800	4800	4800	4700
1-1/4"	4400	4400	4400	4200
1-1/2"	4200	4200	4200	4000
2"	3700	3700	3700	3600

Carbon Steel Pressure Ratings				
Size NPS	ASME B31.1 (PSI)			
	-20°F to 100°F	200°F	300°F	400°F
1/4"	5200	5200	5200	5200
3/8"	5000	5000	5000	5000
1/2"	4900	4900	4900	4900
3/4"	4700	4700	4700	4700
1"	4400	4400	4400	4400
1-1/4"	4100	4100	4100	4100
1-1/2"	3900	3900	3900	3900
2"	3500	3500	3500	3500

Stainless Steel Pressure Ratings				
Size NPS	ASME B31.3 (PSI)			
	-20°F to 100°F	200°F	300°F	400°F
1/4"	5800	5800	5800	5600
3/8"	5600	5600	5600	5400
1/2"	5400	5400	5400	5200
3/4"	5100	5100	5100	5000
1"	4800	4800	4800	4700
1-1/4"	4400	4400	4400	4200
1-1/2"	4200	4200	4200	4000
2"	3700	3700	3700	3600

Carbon Steel Pressure Ratings				
Size NPS	ASME B31.3 (PSI)			
	-20°F to 100°F	200°F	300°F	400°F
1/4"	5200	4900	4700	4500
3/8"	5000	4800	4600	4400
1/2"	4900	4600	4400	4300
3/4"	4700	4400	4200	4100
1"	4400	4200	4000	3900
1-1/4"	4100	3900	3700	3600
1-1/2"	3900	3700	3500	3400
2"	3500	3300	3100	3000

# PYPLOK® Standard Pressure Ratings

## DM 60 Series – OD Tube

Pressure Ratings are based on system temperatures of -15°F to 400°F (-26°C to 205°C) and are limited to the maximum rating of the adjoining tube and/or end connection. Consideration must be taken on PYPLOK® Pressure Ratings and adjoining connection with the lower rated end being the limiting factor.

Stainless Steel Pressure Ratings				
Size OD	4:1 Safety Factor		3:1 Safety Factor	
	PSI	bar	PSI	bar
1/4"	7000	483	9333	644
3/8"	5800	400	7733	533
1/2"	6100	420	8133	561
5/8"	6100	420	8133	561
3/4"	6000	414	8000	552
1"	5800	400	7733	533
1-1/4"	5800	400	7733	533
1-1/2"	5650	390	7533	520
2"	4800	330	6400	441

\*Stainless Steel 316/316L, 2205 Duplex & 2507 Super Duplex pressure ratings.

Carbon Steel Pressure Ratings				
Size OD	4:1 Safety Factor		3:1 Safety Factor	
	PSI	bar	PSI	bar
1/4"	5833	402	7778	536
3/8"	4833	333	6444	444
1/2"	5100	350	6778	467
5/8"	5100	350	6778	467
3/4"	5000	345	6667	460
1"	4833	333	6444	444
1-1/4"	4833	333	6444	444
1-1/2"	4710	325	6278	433
2"	4000	275	5333	368

Copper Nickel Pressure Ratings				
Size OD	4:1 Safety Factor		3:1 Safety Factor	
	PSI	bar	PSI	bar
1/4"	4545	313	6060	418
3/8"	3766	260	5022	346
1/2"	3961	273	5281	364
5/8"	3961	273	5281	364
3/4"	3896	269	5195	358
1"	3766	260	5022	346
1-1/4"	3766	260	5022	346
1-1/2"	3669	253	4892	337
2"	3117	215	4156	287

# PYPLOK® Standard Pressure Ratings

## DM 80 Series – Metric Tube

Pressure Ratings are based on system temperatures of -15°F to 400°F (-26°C to 205°C) and are limited to the maximum rating of the adjoining tube and/or end connection. Consideration must be taken on PYPLOK® Pressure Ratings and adjoining connection with the lower rated end being the limiting factor.

Stainless Steel Pressure Ratings				
Size OD (mm)	4:1 Safety Factor		3:1 Safety Factor	
	PSI	bar	PSI	bar
6	6500	450	8665	600
8	6200	430	8265	570
10	6000	415	8000	550
12	5800	400	7735	535
15	5800	400	7735	535
16	5800	400	7735	535
18	4500	310	6000	415
20	5650	390	7535	520
22	4425	305	5900	405
25	5650	390	7535	520
28	4350	300	5800	400
30	5650	390	7535	520
35	4275	295	5700	395
38	5650	390	7535	520
42	5650	390	7535	520
50	5100	350	6800	470
60	4800	330	6400	440

Carbon Steel Pressure Ratings				
Size OD (mm)	4:1 Safety Factor		3:1 Safety Factor	
	PSI	bar	PSI	bar
6	5420	375	7225	500
8	5170	355	6890	475
10	5000	345	6670	460
12	4835	335	6445	445
15	4835	335	6445	445
16	4835	335	6445	445
18	3750	260	5000	345
20	4710	325	6280	435
22	3690	255	4920	340
25	4710	325	6280	435
28	3625	250	4835	335
30	4710	325	6280	435
35	3560	245	4750	325
38	4710	325	6280	435
42	4710	325	6280	435
50	4250	295	5670	390
60	4000	275	5335	370

\*Stainless Steel 316/316L, 2205 Duplex & 2507 Super Duplex pressure ratings.

# PYPLOK® Standard Pressure Ratings

## DM 80 Series – Metric Tube

Pressure Ratings are based on system temperatures of -15°F to 400°F (-26°C to 205°C) and are limited to the maximum rating of the adjoining tube and/or end connection. Consideration must be taken on PYPLOK® Pressure Ratings and adjoining connection with the lower rated end being the limiting factor.

Copper Nickel Pressure Ratings				
Size OD (mm)	4:1 Safety Factor		3:1 Safety Factor	
	PSI	bar	PSI	bar
6	4220	290	5630	390
8	4025	280	5370	370
10	3895	270	5195	360
12	3765	260	5025	345
16	3765	260	5025	345
20	3670	255	4895	335
25	3670	255	4895	335
30	3670	255	4895	335
38	3670	255	4895	335
42	3670	255	4895	335
50	3315	230	4415	305
60	3120	215	4155	285

# PYPLOK® Standard Pressure Ratings

## DM 80 Series – JIS Metric Tube

Pressure Ratings are based on system temperatures of -15°F to 400°F (-26°C to 205°C) and are limited to the maximum rating of the adjoining tube and/or end connection. Consideration must be taken on PYPLOK® Pressure Ratings and adjoining connection with the lower rated end being the limiting factor.

Stainless Steel Pressure Ratings				
JIS Size	4:1 Safety Factor		3:1 Safety Factor	
	PSI	bar	PSI	bar
06A	3750	260	5000	347
08A	3750	260	5000	347
10A	3750	260	5000	347
15A	3690	255	4920	340
20A	3625	250	4833	333
25A	3560	245	4747	327
32A	3750	260	5000	347
40A	3750	260	5000	347
50A	3750	260	5000	347

Carbon Steel Pressure Ratings				
JIS Size	4:1 Safety Factor		3:1 Safety Factor	
	PSI	bar	PSI	bar
06A	3750	260	5000	347
08A	3750	260	5000	347
10A	3750	260	5000	347
15A	3690	255	4920	340
20A	3625	250	4833	333
25A	3560	245	4747	327
32A	3750	260	5000	347
40A	3750	260	5000	347
50A	3750	260	5000	347

Copper Nickel Pressure Ratings				
JIS Size	4:1 Safety Factor		3:1 Safety Factor	
	PSI	bar	PSI	bar
06A	3750	260	5000	347
08A	3750	260	5000	347
10A	3750	260	5000	347
15A	3670	253	4893	337
20A	3625	250	4833	333
25A	3670	253	4893	337
32A	3315	230	4420	307
40A	3315	230	4420	307
50A	3120	215	4160	287

# PYPLOK® Standard Pressure Ratings

## DP 40N Series – NPS Low Pressure

Pressure Ratings are based on system temperatures of -15°F to 400°F (-26°C to 205°C) and are limited to the maximum rating of the adjoining tube and/or end connection. Consideration must be taken on PYPLOK® Pressure Ratings and adjoining connection with the lower rated end being the limiting factor.

Stainless Steel Pressure Ratings				
Size NPS	4:1 Safety Factor		3:1 Safety Factor	
	PSI	bar	PSI	bar
2-1/2"	500	35	665	45
3"	500	35	665	45
4"	500	35	665	45

\*Stainless Steel 316/316L, 2205 Duplex & 2507 Super Duplex pressure ratings.

Carbon Steel Pressure Ratings				
Size NPS	4:1 Safety Factor		3:1 Safety Factor	
	PSI	bar	PSI	bar
2-1/2"	500	35	665	45
3"	500	35	665	45
4"	500	35	665	45

Copper Nickel Pressure Ratings				
Size NPS	4:1 Safety Factor		3:1 Safety Factor	
	PSI	bar	PSI	bar
2-1/2"	365	25	495	34
3"	365	25	495	34

Titanium Pressure Ratings				
Size NPS	4:1 Safety Factor		3:1 Safety Factor	
	PSI	bar	PSI	bar
2-1/2"	500	35	665	45
3"	500	35	665	45
4"	500	35	665	45

## DP 40M Series – Metric Pipe Low Pressure

Pressure Ratings are based on system temperatures of -15°F to 400°F (-26°C to 205°C) and are limited to the maximum rating of the adjoining tube and/or end connection. Consideration must be taken on PYPLOK® Pressure Ratings and adjoining connection with the lower rated end being the limiting factor.

Copper Nickel Pressure Ratings				
Size OD (mm)	4:1 Safety Factor		3:1 Safety Factor	
	PSI	bar	PSI	bar
44.5	450	31	600	42
57	450	31	600	42

Introduction

Technical Information

DM 20 – NPS Pipe

DM 60 – OD Tube

DM 80 – Metric Tube

DM Series Thread Adapter

DM 80 – Metric & JIS Tube

DP 40N – NPS Low Pressure

DP 40M – Metric Low Pressure

PYPLOK® Tooling

Installation Procedures

Appendix

# Seal Selection

PYPLOK® Fittings are offered with two types of standard seal materials which cover a very broad range of temperatures and compatibility with numerous fluids and gases. The standard seals are VITON and EPDM, both having large application range but many other seal material grades are available to meet specific application requirements. It is the responsibility of the end user to ensure that the seals in the fittings are compatible with the piping system medium and temperature limits. Consult the factory for confirmation of seal compatibility for each system intending to use PYPLOK®. The table below is intended as a reference only for basic guidance to the typical mediums each seal material is appropriate for.

<b>VITON</b>	
<b>Recommended For</b>	<b>Not Recommended For</b>
Petroleum, Mineral and Vegetable Oils Silicone Oils and Grease Aromatic Hydrocarbons (Benzene, Toluene) Chlorinated Hydrocarbons Hydraulic Fluids Solvents and Chemicals	Hot Water and Steam Auto and Brake Fluids Amines Ketones Low Molecular Weight Esters and Ethers

<b>EPDM</b>	
<b>Recommended For</b>	<b>Not Recommended For</b>
Hot Water and Steam Glycol Based Brake Fluids Organic and Inorganic Acids Cleaning Agents, Soda and Potassium Alkalis Phosphate – Ester Hydraulic Fluids Polar Solvents (Alcohols, Ketones, Esters)	Mineral Oil Products Hydrocarbons Greases and Oils

# Thread Size Charts

Dash Thread Size								
Size	4	6	8	12	16	20	24	32
JIC	7/16-20	9/16-18	3/4-16	1 1/16-12	1 5/16-12	1 5/8-12	1 7/8-12	2 1/2-12
NPT	1/4-18	3/8-18	1/2-14	3/4-14	1-11 1/2	1 1/4-11 1/2	1 1/2-11 1/2	2-11 1/2
SAE	7/16-20	9/16-18	3/4-16	1 1/16-12	1 5/16-12	1 5/8-12	1 7/8-12	2 1/2-12
BSPP	1/4-19	3/8-19	1/2-14	3/4-14	1-11	1 1/4-11	1 1/2-11	2-11
ORFS	9/16-18	11/16-16	13/16-16	1 3/16-12	1 7/16-12	1 11/16-12	2-12	N/A

Metric Thread Size "S"									
Size	6S	8S	10S	12S	16S	20S	25S	30S	38S
DIN 2353	M14 x 1.5	M16 x 1.5	M18 x 1.5	M20 x 1.5	M24 x 1.5	M30 x 2.0	M36 x 2.0	M42 x 2.0	M52 x 2.0

Metric Thread Size "L"										
Size	6L	8L	10L	12L	15L	18L	22L	28L	35L	42L
ISO 8434-1	M12 x 1.5	M14 x 1.5	M16 x 1.5	M18 x 1.5	M22 x 1.5	M26 x 1.5	M30 x 2.0	M36 x 2.0	M45 x 2.0	M52 x 2.0

Introduction

Technical Information

DM 20 – NPS Pipe

DM 60 – OD Tube

DM 80 – Metric Tube

DM Series Thread Adapter

DM 80 – Metric & JIS Tube

DP 40N – NPS Low Pressure

DP40M – Metric Low Pressure

PYPLOK® Tooling

Installation Procedures

Appendix





# General Characteristics

## DM 20 Series - NPS Pipe

### Fitting Material Specifications

K = Stainless Steel  
 G = Carbon Steel  
 B = Copper Nickel 70/30  
 C = Copper Nickel 90/10  
 D = Duplex  
 Z = Super Duplex  
 T = Titanium

### Material Specification

ASTM-A479/A182-316  
 ASTM-A105/A350 LF2  
 MIL-C71500  
 MIL-C70600  
 ASTM-A479/A182-UNS31803  
 ASTM-A479/A182-UNS32750  
 ASTM B348 Gr.2

2" NPS DM 20 Series Carbon Steel PYPLOK® cannot be used on EN 10305-4 (E355N/ST52.4) pipe/tube but as replacement 2" NPS DM 20 Series Stainless Steel PYPLOK® or 60mm DM 80 Series Carbon Steel PYPLOK® can be used.

### O-Ring Material Specifications

VITON (Brown Colour)  
 EPDM (Black Colour)

### O-Ring Temperature Limits

-15°F to 400°F (-26°C to 205°C)  
 -60°F to 400°F (-51°C to 205°C)

For seal compatibility and selection for each system consult factory. Other seal materials for specific applications of compatibility and temperature are available upon request.

### Ordering Information

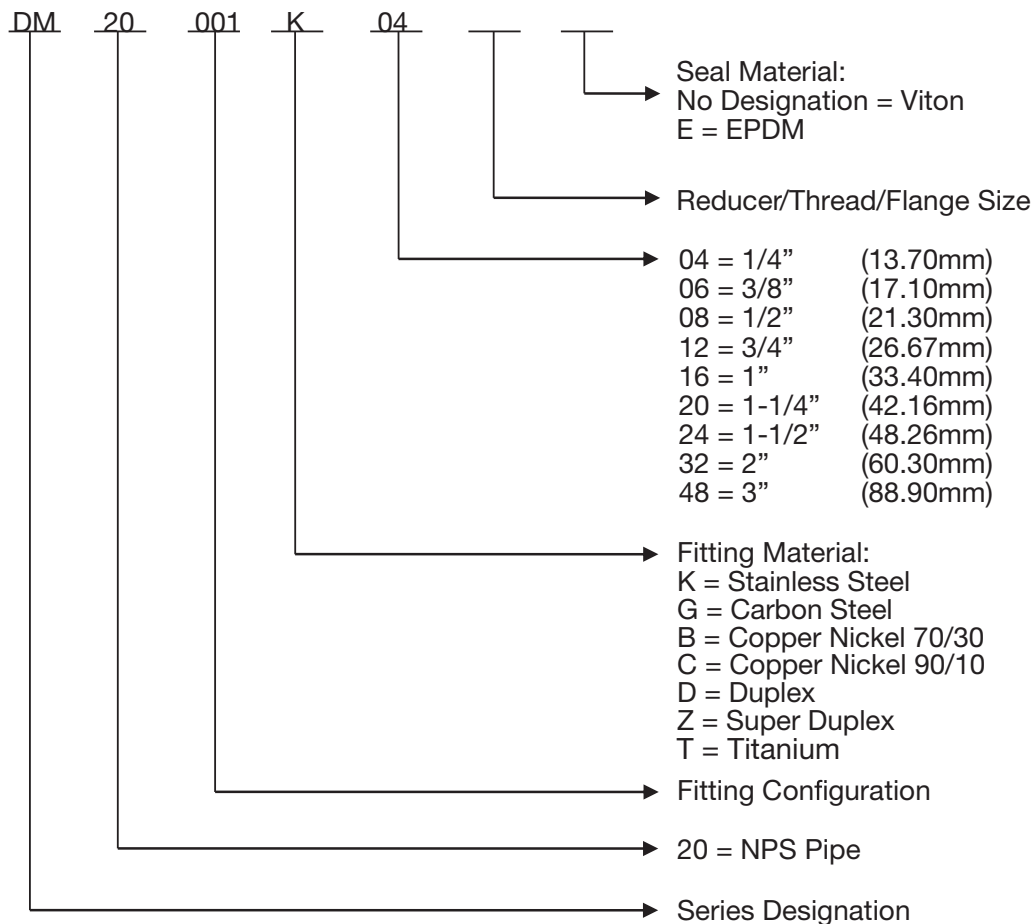











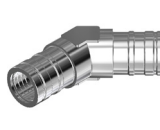









System design and safe application is the responsibility of the end-user. Consideration must be taken to confirm proper fitting selection is made to ensure proper compatibility, function and operation of the fitting within the piping system. The technical and performance information such as weights, dimensions and ratings in this catalogue supersede all previous published data. Tube-Mac® reserves the right to change technical data and product dimension, ratings and other aspects without notice.

# Standard Fitting Configuration Guide

## DM 20 Series - NPS Pipe

1/4" to 3"

					
<b>Coupling</b> DM20001 Page C3	<b>Coupling with Inner Stop</b> DM20002 Page C3	<b>90° Elbow</b> DM20003 Page C4	<b>45° Elbow</b> DM20017 Page C4	<b>Tee</b> DM20004 Page C5	<b>Reducing Tee</b> DM20104 Page C5
					
<b>Reducer</b> DM20101 Page C6	<b>End Cap</b> DM20085 Page C6	<b>Flange - ANSI 150#</b> DM200018 Page C7	<b>Flange - ANSI 300#</b> DM20019 Page C7	<b>Flange - ANSI 600#</b> DM20027 Page C8	<b>SAE Flange Body</b> DM20090 Page C8
					
<b>SAE Code 61 Flange</b> DM20091 Page C9	<b>SAE Code 62 Flange</b> DM20092 Page C9	<b>SAE Code 61 Tapped Flange</b> DM20095 Page C10	<b>SAE Code 62 Tapped Flange</b> DM20096 Page C10	<b>JIC 37° Male</b> DM20055 Page C11	<b>JIC 37° Female Swivel</b> DM20054 Page C11
					
<b>NPT Male</b> DM20056 Page C12	<b>NPT Female</b> DM20060 Page C12	<b>SAE Male</b> DM20088 Page C13	<b>SAE Female</b> DM20087 Page C13	<b>BSPP Male</b> DM20153 Page C14	<b>BSPP Female</b> DM20086 Page C14
					
<b>ORFS Male</b> DM20010 Page C15	<b>ORFS Female Swivel</b> DM20020 Page C15	<b>Weldable Bulkhead</b> DM60089 Page C16	<b>SAE Female Branch Tee</b> DM20171 Page C16	<b>BSPP Female Branch Tee</b> DM20172 Page C17	<b>NPT Female Branch Tee</b> DM20173 Page C17

# DM 20 Series - NPS Pipe

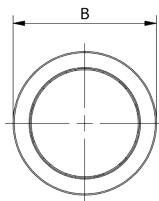
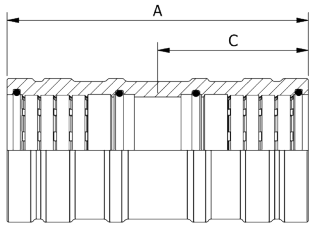

**\*MATERIAL CODE:**  
**K = STAINLESS STEEL**  
**G = CARBON STEEL**  
**B = COPPER NICKEL 70/30**

**ORDER EXAMPLE:**  
**DM20001G04**

## Coupling, NPS - DM20001

Size NPS	Part Number	Dimensions - Inch (mm)			*Weight K & G lbs (kg)
		A	B	C Insertion Depth	
1/4"	DM20001*04	2.25 (57.15)	0.80 (20.32)	1.13 (28.70)	0.12 (0.05)
3/8"	DM20001*06	2.75 (69.85)	0.99 (25.15)	1.38 (35.05)	0.25 (0.11)
1/2"	DM20001*08	3.00 (76.20)	1.20 (30.48)	1.50 (38.10)	0.44 (0.20)
3/4"	DM20001*12	3.50 (88.90)	1.48 (37.59)	1.75 (44.45)	0.61 (0.28)
1"	DM20001*16	4.00 (101.60)	1.82 (46.23)	2.00 (50.80)	1.07 (0.49)
1-1/4"	DM20001*20	4.75 (120.65)	2.26 (57.40)	2.38 (60.45)	2.00 (0.91)
1-1/2"	DM20001*24	5.00 (127.00)	2.58 (65.53)	2.50 (63.50)	2.78 (1.26)
2"	DM20001*32	7.00 (177.80)	3.04 (77.22)	3.50 (88.90)	4.40 (2.00)
3"	DM20001*48	10.00 (254.00)	4.38 (111.25)	5.00 (127.00)	14.06 (6.38)

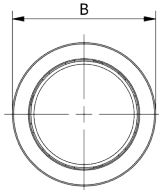
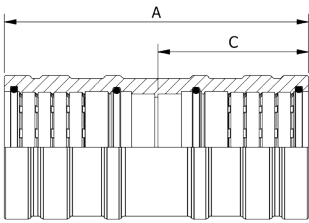

**\*MATERIAL CODE:**  
**K = STAINLESS STEEL**  
**G = CARBON STEEL**  
**B = COPPER NICKEL 70/30**

**ORDER EXAMPLE:**  
**DM20002G04**

## Coupling with Inner Stop, NPS - DM20002

Size NPS	Part Number	Dimensions - Inch (mm)			*Weight K & G lbs (kg)
		A	B	C Insertion Depth	
1/4"	DM20002*04	2.30 (58.42)	0.80 (20.32)	1.13 (28.70)	0.12 (0.05)
3/8"	DM20002*06	2.80 (71.12)	0.99 (25.15)	1.38 (35.05)	0.25 (0.11)
1/2"	DM20002*08	3.05 (77.47)	1.20 (30.48)	1.50 (38.10)	0.35 (0.16)
3/4"	DM20002*12	3.55 (90.17)	1.48 (37.59)	1.75 (44.45)	0.61 (0.28)
1"	DM20002*16	4.05 (102.87)	1.82 (46.23)	2.00 (50.80)	1.07 (0.49)
1-1/4"	DM20002*20	4.80 (121.92)	2.26 (57.40)	2.38 (60.45)	1.96 (0.89)
1-1/2"	DM20002*24	5.05 (128.27)	2.58 (65.53)	2.50 (63.50)	2.78 (1.26)
2"	DM20002*32	7.05 (179.07)	3.04 (77.22)	3.50 (88.90)	4.40 (2.00)
3"	DM20002*48	10.05 (255.27)	4.38 (111.25)	5.00 (127.00)	12.21 (5.54)

3D step models available upon request

# DM 20 Series - NPS Pipe

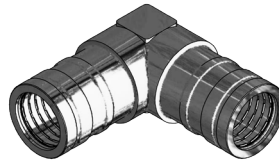
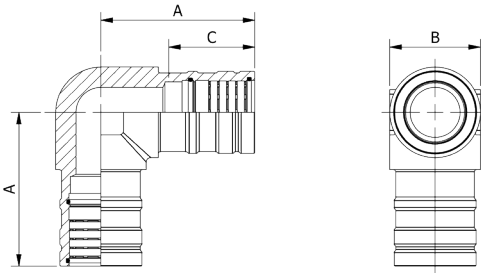

**\*MATERIAL CODE:**  
 K = STAINLESS STEEL  
 G = CARBON STEEL  
 B = COPPER NICKEL 70/30

**ORDER EXAMPLE:**  
 DM20003G04

## 90° Elbow, NPS - DM20003

Size NPS	Part Number	Dimensions - Inch (mm)			*Weight K & G lbs (kg)
		A	B	C Insertion Depth	
1/4"	DM20003*04	1.75 (44.45)	0.86 (21.84)	1.13 (28.70)	0.29 (0.13)
3/8"	DM20003*06	2.00 (50.80)	1.06 (26.92)	1.38 (35.05)	0.56 (0.25)
1/2"	DM20003*08	2.68 (68.07)	1.30 (33.02)	1.50 (38.10)	1.00 (0.45)
3/4"	DM20003*12	3.03 (76.96)	1.58 (40.13)	1.75 (44.45)	1.50 (0.68)
1"	DM20003*16	3.37 (85.60)	1.97 (50.04)	2.00 (50.80)	2.65 (1.20)
1-1/4"	DM20003*20	4.25 (107.95)	2.50 (63.50)	2.38 (60.45)	5.95 (2.70)
1-1/2"	DM20003*24	4.54 (115.32)	2.81 (71.37)	2.50 (63.50)	7.10 (3.22)
2"	DM20003*32	5.45 (138.43)	3.25 (82.55)	3.50 (88.90)	9.60 (4.35)
**3"	DM20003*48	11.09 (281.69)	4.38 (111.25)	5.00 (127.00)	25.23 (11.44)

\*\*3" PYPLOCK® DM 20 Series shapes such as Tees and Elbows are made as welded assemblies using ASME B16.9 SCH.160 Butt Weld Fittings. All other sizes are made from forged material.

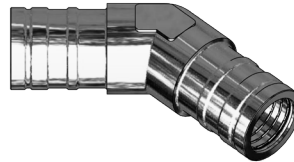
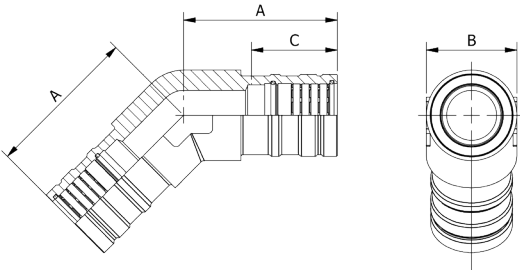

**\*MATERIAL CODE:**  
 K = STAINLESS STEEL  
 G = CARBON STEEL  
 B = COPPER NICKEL 70/30

**ORDER EXAMPLE:**  
 DM20017G04

## 45° Elbow, NPS - DM20017

Size NPS	Part Number	Dimensions - Inch (mm)			*Weight K & G lbs (kg)
		A	B	C Insertion Depth	
1/4"	DM20017*04	1.75 (44.45)	0.86 (21.84)	1.13 (28.70)	0.40 (0.18)
3/8"	DM20017*06	2.00 (50.80)	1.06 (26.92)	1.38 (35.05)	0.50 (0.23)
1/2"	DM20017*08	2.68 (68.07)	1.30 (33.02)	1.50 (38.10)	1.00 (0.45)
3/4"	DM20017*12	3.03 (76.96)	1.58 (40.13)	1.75 (44.45)	1.50 (0.68)
1"	DM20017*16	3.37 (85.60)	1.97 (50.04)	2.00 (50.80)	3.10 (1.41)
1-1/4"	DM20017*20	4.25 (107.95)	2.50 (63.50)	2.38 (60.45)	5.60 (2.54)
1-1/2"	DM20017*24	4.54 (115.32)	2.81 (71.37)	2.50 (63.50)	7.40 (3.36)
2"	DM20017*32	5.45 (138.43)	3.25 (82.55)	3.50 (88.90)	9.60 (4.35)
**3"	DM20017*48	8.59 (218.19)	4.38 (111.25)	5.00 (127.00)	21.26 (9.64)

\*\*3" PYPLOCK® DM 20 Series shapes such as Tees and Elbows are made as welded assemblies using ASME B16.9 SCH.160 Butt Weld Fittings. All other sizes are made from forged material.

# DM 20 Series - NPS Pipe

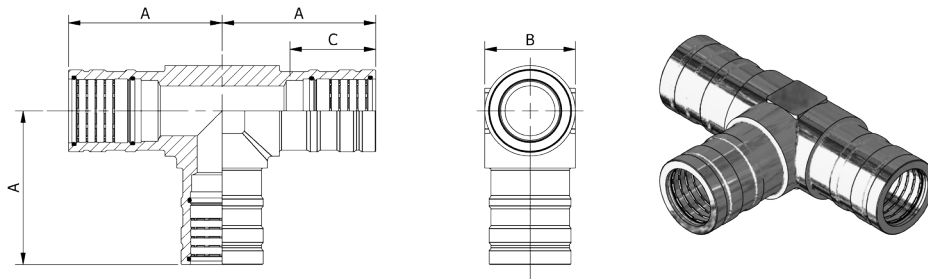

**\*MATERIAL CODE:**  
 K = STAINLESS STEEL  
 G = CARBON STEEL  
 B = COPPER NICKEL 70/30

**ORDER EXAMPLE:**  
 DM20004G04

## Tee, NPS - DM20004

Size NPS	Part Number	Dimensions - Inch (mm)			*Weight K & G lbs (kg)
		A	B	C Insertion Depth	
1/4"	DM20004*04	1.75 (44.45)	0.86 (21.84)	1.13 (28.70)	0.38 (0.17)
3/8"	DM20004*06	2.00 (50.80)	1.06 (26.92)	1.38 (35.05)	0.65 (0.29)
1/2"	DM20004*08	2.68 (68.07)	1.30 (33.02)	1.50 (38.10)	1.30 (0.59)
3/4"	DM20004*12	3.03 (76.96)	1.58 (40.13)	1.75 (44.45)	2.00 (0.91)
1"	DM20004*16	3.37 (85.60)	1.97 (50.04)	2.00 (50.80)	3.40 (1.54)
1-1/4"	DM20004*20	4.25 (107.95)	2.50 (63.50)	2.38 (60.45)	7.10 (3.22)
1-1/2"	DM20004*24	4.54 (115.32)	2.81 (71.37)	2.50 (63.50)	9.20 (4.17)
2"	DM20004*32	5.45 (138.43)	3.25 (82.55)	3.50 (88.90)	12.80 (5.81)
**3"	DM20004*48	9.97 (253.24)	4.38 (111.25)	5.00 (127.00)	34.95 (15.85)

\*\*3" PYPLOK® DM 20 Series shapes such as Tees and Elbows are made as welded assemblies using ASME B16.9 SCH.160 Butt Weld Fittings. All other sizes are made from forged material.

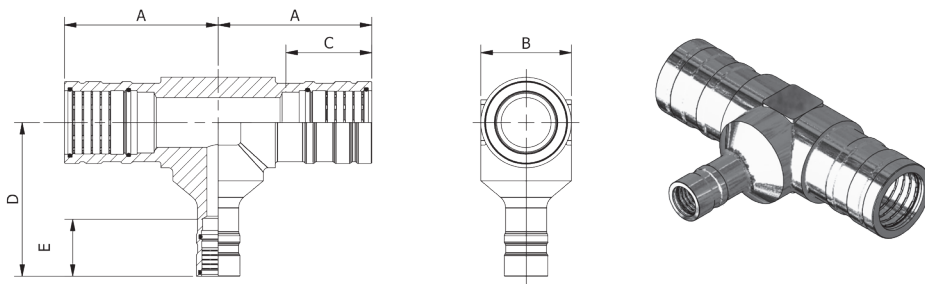

**\*MATERIAL CODE:**  
 K = STAINLESS STEEL  
 G = CARBON STEEL  
 B = COPPER NICKEL 70/30

**ORDER EXAMPLE:**  
 DM20104G0604

Other configurations available.  
 Contact factory for details.

## Reducing Tee, NPS - DM20104

Run Size NPS	Branch Size NPS	Part Number	Dimensions - Inch (mm)					*Weight K & G lbs (kg)
			A	B	C Insertion Depth	D	E Insertion Depth	
3/8"	1/4"	DM20104*0604	2.00 (50.80)	1.06 (26.92)	1.38 (35.05)	2.00 (50.80)	1.13 (28.70)	0.62 (0.28)
1/2"	3/8"	DM20104*0806	2.68 (68.07)	1.30 (33.02)	1.50 (38.10)	2.50 (63.50)	1.38 (35.05)	1.30 (0.59)
3/4"	1/2"	DM20104*1208	3.03 (76.96)	1.58 (40.13)	1.75 (44.45)	3.13 (79.50)	1.50 (38.10)	2.00 (0.91)
1"	1/2"	DM20104*1608	3.37 (85.60)	1.97 (50.04)	2.00 (50.80)	3.27 (83.06)	1.50 (38.10)	3.20 (1.45)
1"	3/4"	DM20104*1612	3.37 (85.60)	1.97 (50.04)	2.00 (50.80)	3.37 (85.60)	1.75 (44.45)	3.20 (1.45)
1 1/4"	1/2"	DM20104*2008	4.25 (107.95)	2.50 (63.50)	2.38 (60.45)	4.25 (107.95)	1.50 (38.10)	6.80 (3.08)
1-1/4"	3/4"	DM20104*2012	4.25 (107.95)	2.50 (63.50)	2.38 (60.45)	4.25 (107.95)	1.75 (44.45)	6.80 (3.08)
1-1/4"	1"	DM20104*2016	4.25 (107.95)	2.50 (63.50)	2.38 (60.45)	4.25 (107.95)	2.00 (50.80)	6.80 (3.08)
1 1/2"	3/4"	DM20104*2412	4.54 (115.32)	2.81 (71.37)	2.50 (63.50)	4.54 (115.32)	1.75 (44.45)	8.80 (3.99)
1-1/2"	1"	DM20104*2416	4.54 (115.32)	2.81 (71.37)	2.50 (63.50)	4.54 (115.32)	2.00 (50.80)	8.80 (3.99)
1-1/2"	1-1/4"	DM20104*2420	4.54 (115.32)	2.81 (71.37)	2.50 (63.50)	4.54 (115.32)	2.38 (60.45)	8.80 (3.99)
2"	1"	DM20104*3216	5.45 (138.43)	3.25 (82.55)	3.50 (88.90)	5.38 (136.65)	2.00 (50.80)	12.40 (5.62)
2"	1-1/4"	DM20104*3220	5.45 (138.43)	3.25 (82.55)	3.50 (88.90)	5.38 (136.65)	2.38 (60.45)	13.10 (5.94)
2"	1-1/2"	DM20104*3224	5.45 (138.43)	3.25 (82.55)	3.50 (88.90)	5.38 (136.65)	2.50 (63.50)	13.40 (6.08)

3D step models available upon request

# DM 20 Series - NPS Pipe

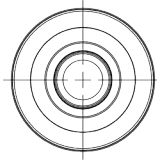
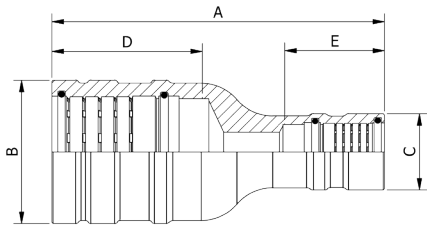

\*MATERIAL CODE:  
 K = STAINLESS STEEL  
 G = CARBON STEEL  
 B = COPPER NICKEL 70/30

ORDER EXAMPLE:  
 DM20101G0604

Other configurations available.  
 Contact factory for details.

## Reducer, NPS - DM20101

End 1 Size NPS	End 2 Size NPS	Part Number	Dimensions - Inch (mm)					*Weight K & G lbs (kg)
			A	B	C	D Insertion Depth	E Insertion Depth	
3/8"	1/4"	DM20101*0604	3.00 (76.20)	0.99 (25.15)	0.80 (20.32)	1.38 (35.05)	1.13 (28.70)	0.26 (0.12)
1/2"	3/8"	DM20101*0806	3.75 (95.25)	1.20 (30.48)	0.99 (25.15)	1.50 (38.10)	1.38 (35.05)	0.40 (0.18)
3/4"	1/2"	DM20101*1208	4.38 (111.25)	1.48 (37.59)	1.20 (30.48)	1.75 (44.45)	1.50 (38.10)	0.70 (0.32)
1"	1/2"	DM20101*1608	5.00 (127.00)	1.82 (46.23)	1.20 (30.48)	2.00 (50.80)	1.50 (38.10)	1.25 (0.57)
1"	3/4"	DM20101*1612	5.00 (127.00)	1.82 (46.23)	1.48 (37.59)	2.00 (50.80)	1.75 (44.45)	1.30 (0.59)
1-1/4"	3/4"	DM20101*2012	5.38 (136.65)	2.26 (57.40)	1.48 (37.59)	2.38 (60.45)	1.75 (44.45)	1.80 (0.82)
1-1/4"	1"	DM20101*2016	5.38 (136.65)	2.26 (57.40)	1.82 (46.23)	2.38 (60.45)	2.00 (50.80)	2.04 (0.93)
1-1/2"	3/4"	DM20101*2412	5.88 (149.35)	2.58 (65.53)	1.48 (37.59)	2.50 (63.50)	1.75 (44.45)	2.82 (1.28)
1-1/2"	1"	DM20101*2416	5.88 (149.35)	2.58 (65.53)	1.82 (46.23)	2.50 (63.50)	2.00 (50.80)	2.85 (1.29)
1-1/2"	1-1/4"	DM20101*2420	6.00 (154.43)	2.58 (65.53)	2.26 (57.40)	2.50 (63.50)	2.38 (60.45)	3.17 (1.44)
2"	1"	DM20101*3216	7.00 (177.80)	3.04 (77.22)	1.82 (46.23)	3.50 (88.90)	2.00 (50.80)	3.69 (1.67)
2"	1-1/4"	DM20101*3220	7.25 (184.15)	3.04 (77.22)	2.26 (57.40)	3.50 (88.90)	2.38 (60.45)	4.20 (1.90)
2"	1-1/2"	DM20101*3224	7.50 (190.05)	3.04 (77.22)	2.58 (65.53)	3.50 (88.90)	2.50 (63.50)	4.67 (2.12)

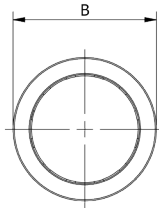
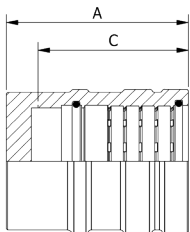

\*MATERIAL CODE:  
 K = STAINLESS STEEL  
 G = CARBON STEEL  
 B = COPPER NICKEL 70/30

ORDER EXAMPLE:  
 DM20085G04

## End Cap, NPS - DM20085

Size NPS	Part Number	Dimensions - Inch (mm)			*Weight K & G lbs (kg)
		A	B	C Insertion Depth	
1/4"	DM20085*04	1.38 (35.05)	0.80 (20.32)	1.13 (28.70)	0.10 (0.05)
3/8"	DM20085*06	1.88 (47.75)	0.99 (25.15)	1.38 (35.05)	0.20 (0.09)
1/2"	DM20085*08	2.00 (50.80)	1.20 (30.48)	1.50 (38.10)	0.30 (0.14)
3/4"	DM20085*12	2.25 (57.15)	1.48 (37.59)	1.75 (44.45)	0.50 (0.23)
1"	DM20085*16	2.50 (63.50)	1.82 (46.23)	2.00 (50.80)	0.84 (0.38)
1-1/4"	DM20085*20	2.88 (73.15)	2.26 (57.40)	2.38 (60.45)	1.44 (0.65)
1-1/2"	DM20085*24	3.00 (76.20)	2.58 (65.53)	2.50 (63.50)	1.98 (0.90)
2"	DM20085*32	4.13 (104.90)	3.04 (77.22)	3.50 (88.90)	3.13 (1.42)
3"	DM20085*48	5.63 (143.00)	4.38 (111.25)	5.00 (127.00)	8.56 (3.88)

3D step models available upon request

# DM 20 Series - NPS Pipe

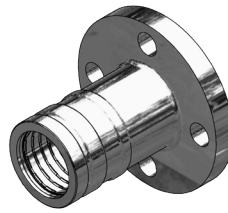
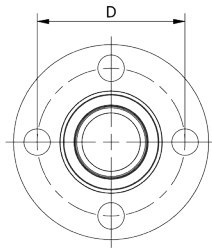
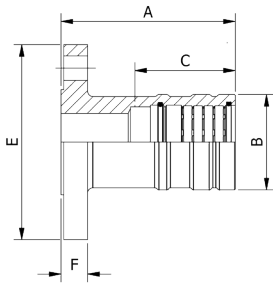

**\*MATERIAL CODE:**  
**K = STAINLESS STEEL**  
**G = CARBON STEEL**  
**B = COPPER NICKEL 70/30**

**ORDER EXAMPLE:**  
**DM20018G08**

## Flange – ANSI 150#, NPS - DM20018

Size NPS	Flange Size	Part Number	Dimensions - Inch (mm)						Bolt Size	*Weight K & G lbs (kg)
			A	B	C Insertion Depth	D	E	F		
1/2"	1/2"	DM20018*08	3.00 (76.20)	1.20 (30.48)	1.50 (38.10)	2.38 (60.45)	3.50 (88.90)	0.44 (11.18)	1/2" UNC	1.30 (0.59)
3/4"	3/4"	DM20018*12	3.50 (88.90)	1.48 (37.59)	1.75 (44.45)	2.75 (69.85)	3.88 (98.55)	0.50 (12.70)	1/2" UNC	1.90 (0.86)
1"	1"	DM20018*16	3.63 (92.20)	1.82 (46.23)	2.00 (50.80)	3.12 (79.25)	4.25 (107.95)	0.62 (15.82)	1/2" UNC	3.00 (1.36)
1-1/4"	1-1/4"	DM20018*20	4.13 (104.90)	2.26 (57.40)	2.38 (60.45)	3.50 (88.90)	4.62 (117.35)	0.63 (16.00)	1/2" UNC	4.09 (1.86)
1-1/2"	1-1/2"	DM20018*24	4.25 (107.95)	2.58 (65.53)	2.50 (63.50)	3.88 (98.55)	5.00 (127.00)	0.75 (19.10)	1/2" UNC	5.20 (2.40)
2"	2"	DM20018*32	5.73 (145.54)	3.04 (77.22)	3.50 (88.90)	4.75 (120.65)	6.00 (152.40)	0.69 (17.53)	5/8" UNC	8.50 (3.86)
**3"	3"	DM20018*48	9.34 (237.24)	4.38 (111.25)	5.00 (127.00)	6.00 (152.40)	7.50 (190.50)	1.31 (33.27)	5/8" UNC	24.83 (11.26)

\*\*3" PYPLOCK® DM 20 Series shapes such as Tees and Elbows are made as welded assemblies using ASME B16.9 SCH.160 Butt Weld Fittings. All other sizes are made from forged material.

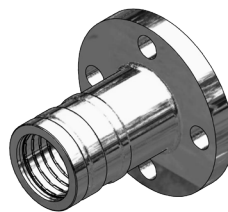
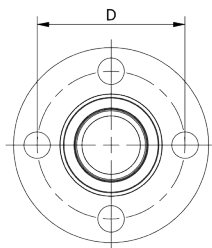
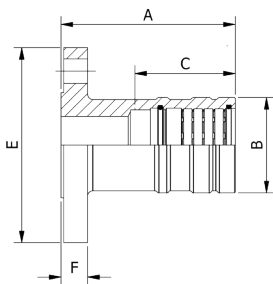

**\*MATERIAL CODE:**  
**K = STAINLESS STEEL**  
**G = CARBON STEEL**  
**B = COPPER NICKEL 70/30**

**ORDER EXAMPLE:**  
**DM20019G08**

## Flange – ANSI 300#, NPS - DM20019

Size NPS	Flange Size	Part Number	Dimensions - Inch (mm)						Bolt Size	*Weight K & G lbs (kg)
			A	B	C Insertion Depth	D	E	F		
1/2"	1/2"	DM20019*08	3.13 (79.50)	1.20 (30.48)	1.50 (38.10)	2.62 (66.55)	3.75 (95.25)	0.56 (14.22)	1/2" UNC	1.84 (0.83)
3/4"	3/4"	DM20019*12	3.63 (92.20)	1.48 (37.59)	1.75 (44.45)	3.25 (82.55)	4.63 (117.60)	0.63 (16.00)	5/8" UNC	3.10 (1.41)
1"	1"	DM20019*16	3.88 (98.55)	1.82 (46.23)	2.00 (50.80)	3.50 (88.90)	4.88 (123.95)	0.75 (19.05)	5/8" UNC	4.34 (1.97)
1-1/4"	1-1/4"	DM20019*20	4.25 (107.95)	2.26 (57.40)	2.38 (60.45)	3.88 (98.55)	5.25 (133.35)	0.75 (19.05)	5/8" UNC	5.40 (2.45)
1-1/2"	1-1/2"	DM20019*24	4.31 (109.47)	2.58 (65.53)	2.50 (63.50)	4.50 (114.30)	6.12 (155.45)	0.81 (20.57)	3/4" UNC	9.70 (4.40)
**2"	2"	DM20019*32	5.80 (147.32)	3.04 (77.72)	3.50 (88.90)	5.00 (127.00)	6.50 (165.10)	0.88 (22.35)	5/8" UNC	9.77 (4.43)
**3"	3"	DM20019*48	9.72 (246.89)	4.38 (111.25)	5.00 (127.00)	6.63 (168.40)	8.25 (209.55)	1.13 (28.70)	3/4" UNC	26.15 (11.86)

\*\*2" ANSI 300# Flange has 8 Bolts.

\*\*3" PYPLOCK® DM 20 Series shapes such as Tees and Elbows are made as welded assemblies using ASME B16.9 SCH.160 Butt Weld Fittings. All other sizes are made from forged material.

3D step models available upon request



# DM 20 Series - NPS Pipe

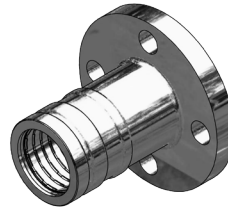
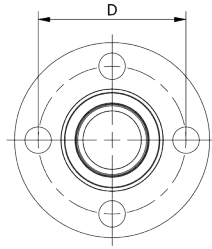
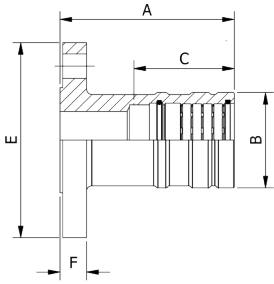

**\*MATERIAL CODE:**  
 K = STAINLESS STEEL  
 G = CARBON STEEL  
 B = COPPER NICKEL 70/30

**ORDER EXAMPLE:**  
 DM20027G08

## Flange – ANSI 600#, NPS - DM20027

Size NPS	Flange Size	Part Number	Dimensions - Inch (mm)						Bolt Size	*Weight K & G lbs (kg)
			A	B	C Insertion Depth	D	E	F		
1/2"	1/2"	DM20027*08	3.31 (84.07)	1.20 (30.48)	1.50 (38.10)	2.63 (66.80)	3.75 (95.25)	0.81 (20.57)	1/2 UNC	2.07 (0.94)
3/4"	3/4"	DM20027*12	3.81 (96.77)	1.48 (37.59)	1.75 (44.45)	3.25 (82.55)	4.63 (117.60)	0.88 (22.35)	5/8 UNC	3.53 (1.60)
1"	1"	DM20027*16	4.00 (101.60)	1.82 (46.23)	2.00 (50.80)	3.50 (88.90)	4.88 (123.95)	0.94 (23.88)	5/8 UNC	4.51 (2.05)
1-1/4"	1-1/4"	DM20027*20	4.50 (114.30)	2.26 (57.40)	2.38 (60.45)	3.88 (98.55)	5.25 (133.35)	1.06 (26.92)	5/8 UNC	6.48 (2.94)
1-1/2"	1-1/2"	DM20027*24	4.63 (117.60)	2.58 (65.53)	2.50 (63.50)	4.50 (114.30)	6.13 (155.70)	1.13 (28.70)	3/4 UNC	9.13 (4.14)
2"	2"	DM20027*32	5.73 (145.54)	3.04 (77.22)	3.50 (88.90)	5.00 (127.00)	6.50 (165.10)	1.25 (31.75)	5/8 UNC	10.92 (4.95)
**3"	3"	DM20027*48	9.97 (253.24)	4.38 (111.25)	5.00 (127.00)	6.63 (168.40)	8.13 (206.50)	1.38 (35.05)	3/4 UNC	25.76 (11.68)

\*\*3" PYPLOK® DM 20 Series shapes such as Tees and Elbows are made as welded assemblies using ASME B16.9 SCH.160 Butt Weld Fittings. All other sizes are made from forged material.

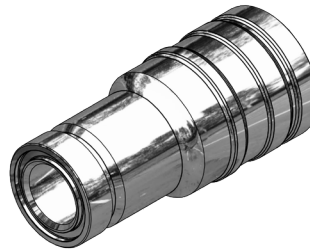
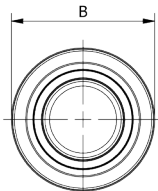
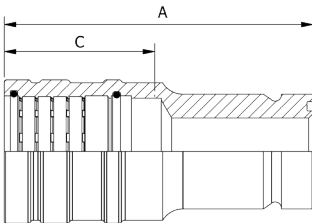

**\*MATERIAL CODE:**  
 K = STAINLESS STEEL  
 G = CARBON STEEL  
 B = COPPER NICKEL 70/30

**ORDER EXAMPLE:**  
 DM20090G08

## SAE Flange Body, NPS - DM20090

Size NPS	Flange Size	Part Number	Dimensions - Inch (mm)			*Weight K & G lbs (kg)
			A	B	C Insertion Depth	
1/2"	1/2"	DM20090*08	3.38 (85.85)	1.20 (30.48)	1.50 (38.10)	0.51 (0.23)
3/4"	3/4"	DM20090*12	3.50 (88.90)	1.48 (37.59)	1.75 (44.45)	0.87 (0.39)
1"	1"	DM20090*16	4.50 (114.30)	1.82 (46.23)	2.00 (50.80)	1.49 (0.68)
1-1/4"	1-1/4"	DM20090*20	4.88 (123.95)	2.26 (57.40)	2.38 (60.45)	2.13 (0.97)
1-1/2"	1-1/2"	DM20090*24	5.00 (127.00)	2.58 (65.53)	2.50 (63.50)	3.00 (1.36)
2"	2"	DM20090*32	6.50 (165.10)	3.04 (77.22)	3.50 (88.90)	4.43 (2.01)
3"	3"	DM20090*48	9.50 (241.30)	4.38 (111.25)	5.00 (127.00)	13.41 (6.08)

# DM 20 Series - NPS Pipe

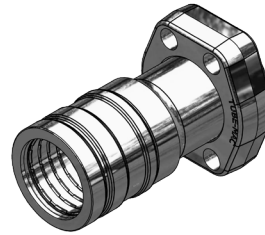
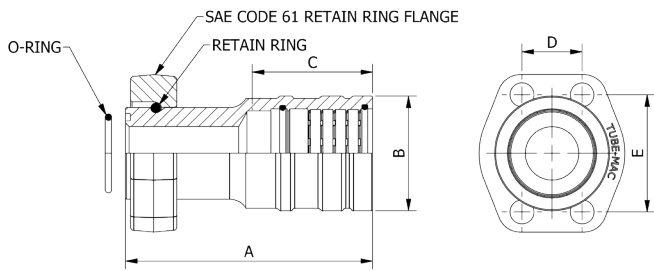

**\*MATERIAL CODE:**  
 K = STAINLESS STEEL  
 G = CARBON STEEL  
 B = COPPER NICKEL 70/30

**ORDER EXAMPLE:**  
 DM20091G08

## SAE Code 61 Flange, NPS - DM20091

Size NPS	Flange Size	Part Number	Dimensions - Inch (mm)					Bolt Minimum Grade 8	*Weight K & G lbs (kg)
			A	B	C Insertion Depth	D	E		
1/2"	1/2"	DM20091*08	3.38 (85.85)	1.20 (30.48)	1.50 (38.10)	0.69 (17.53)	1.50 (38.10)	5/16" UNC	0.97 (0.44)
3/4"	3/4"	DM20091*12	3.50 (88.90)	1.48 (37.59)	1.75 (44.45)	0.88 (22.35)	1.88 (47.75)	3/8" UNC	1.35 (0.61)
1"	1"	DM20091*16	4.50 (114.30)	1.82 (46.23)	2.00 (50.80)	1.03 (26.16)	2.06 (52.32)	3/8" UNC	2.12 (0.96)
1-1/4"	1-1/4"	DM20091*20	4.88 (123.95)	2.26 (57.40)	2.38 (60.45)	1.19 (30.23)	2.31 (58.67)	7/16" UNC	3.03 (1.37)
1-1/2"	1-1/2"	DM20091*24	5.00 (127.00)	2.58 (65.53)	2.50 (63.50)	1.41 (35.81)	2.75 (69.85)	1/2" UNC	4.35 (1.97)
2"	2"	DM20091*32	6.50 (165.10)	3.04 (77.22)	3.50 (88.90)	1.69 (42.93)	3.06 (77.72)	1/2" UNC	6.45 (2.93)
3"	3"	DM20091*48	9.50 (241.30)	4.38 (111.25)	5.00 (127.00)	2.44 (61.98)	4.19 (106.43)	5/8" UNC	17.51 (7.90)

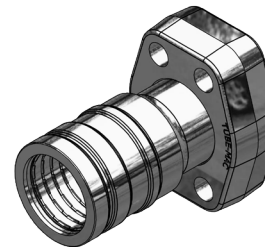
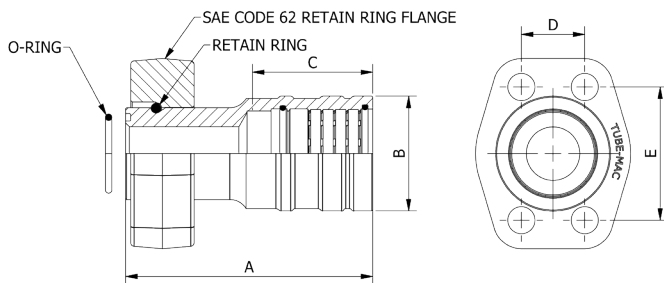

**\*MATERIAL CODE:**  
 K = STAINLESS STEEL  
 G = CARBON STEEL  
 B = COPPER NICKEL 70/30

**ORDER EXAMPLE:**  
 DM20092G08

## SAE Code 62 Flange, NPS - DM20092

Size NPS	Flange Size	Part Number	Dimensions - Inch (mm)					Bolt Minimum Grade 8	*Weight K & G lbs (kg)
			A	B	C Insertion Depth	D	E		
1/2"	1/2"	DM20092*08	3.38 (85.85)	1.20 (30.48)	1.50 (38.10)	0.72 (18.29)	1.59 (40.39)	5/16" UNC	0.97 (0.44)
3/4"	3/4"	DM20092*12	3.50 (88.90)	1.48 (37.59)	1.75 (44.45)	0.94 (23.88)	2.00 (50.80)	3/8" UNC	1.68 (0.76)
1"	1"	DM20092*16	4.50 (114.30)	1.82 (46.23)	2.00 (50.80)	1.09 (27.69)	2.25 (57.15)	7/16" UNC	2.75 (1.25)
1-1/4"	1-1/4"	DM20092*20	4.88 (123.95)	2.26 (57.40)	2.38 (60.45)	1.25 (31.75)	2.63 (66.80)	1/2" UNC	4.08 (1.85)
1-1/2"	1-1/2"	DM20092*24	5.00 (127.00)	2.58 (65.53)	2.50 (63.50)	1.44 (36.58)	3.13 (79.50)	5/8" UNC	5.88 (2.67)
2"	2"	DM20092*32	6.50 (165.10)	3.04 (77.22)	3.50 (88.90)	1.75 (44.45)	3.81 (96.77)	3/4" UNC	9.83 (4.46)
**3"	3"	DM20092*48	9.50 (241.30)	4.38 (111.25)	5.00 (127.00)	2.44 (61.98)	4.19 (106.43)	5/8" UNC	22.51 (10.21)

\*\*3" uses ISO 6164 Flange.

3D step models available upon request

# DM 20 Series - NPS Pipe

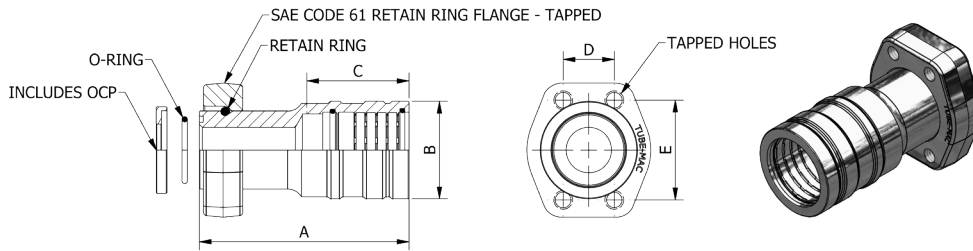

\*MATERIAL CODE:  
 K = STAINLESS STEEL  
 G = CARBON STEEL  
 B = COPPER NICKEL 70/30

ORDER EXAMPLE:  
 DM20095G08

## SAE Code 61 Tapped Flange, NPS - DM20095

Size NPS	Flange Size	Part Number	Dimensions - Inch (mm)					Tap UNC-2B	*Weight K & G lbs (kg)
			A	B	C Insertion Depth	D	E		
1/2"	1/2"	DM20095*08	3.38 (85.85)	1.20 (30.48)	1.50 (38.10)	0.69 (17.53)	1.50 (38.10)	5/16"-18	1.01 (0.46)
3/4"	3/4"	DM20095*12	3.50 (88.90)	1.48 (37.59)	1.75 (44.45)	0.88 (22.35)	1.88 (47.75)	3/8"-16	1.42 (0.64)
1"	1"	DM20095*16	4.50 (114.30)	1.82 (46.23)	2.00 (50.80)	1.03 (26.16)	2.06 (52.32)	3/8"-16	2.20 (1.00)
1-1/4"	1-1/4"	DM20095*20	4.88 (123.95)	2.26 (57.40)	2.38 (60.45)	1.19 (30.23)	2.31 (58.67)	7/16"-14	3.12 (1.42)
1-1/2"	1-1/2"	DM20095*24	5.00 (127.00)	2.58 (65.53)	2.50 (63.50)	1.41 (35.81)	2.75 (69.85)	1/2"-13	4.52 (2.05)
2"	2"	DM20095*32	6.50 (165.10)	3.04 (77.22)	3.50 (88.90)	1.69 (42.93)	3.06 (77.72)	1/2"-13	6.60 (2.99)
3"	3"	DM20095*48	9.50 (241.30)	4.38 (111.25)	5.00 (127.00)	2.44 (61.98)	4.19 (106.43)	5/8"-11	17.51 (7.90)

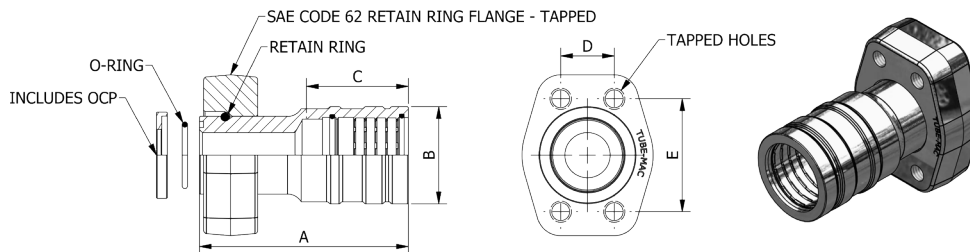

\*MATERIAL CODE:  
 K = STAINLESS STEEL  
 G = CARBON STEEL  
 B = COPPER NICKEL 70/30

ORDER EXAMPLE:  
 DM20096G08

## SAE Code 62 Tapped Flange, NPS - DM20096

Size NPS	Flange Size	Part Number	Dimensions - Inch (mm)					Tap UNC-2B	*Weight K & G lbs (kg)
			A	B	C Insertion Depth	D	E		
1/2"	1/2"	DM20096*08	3.38 (85.85)	1.20 (30.48)	1.50 (38.10)	0.72 (18.29)	1.59 (40.39)	5/16"-18	1.01 (0.46)
3/4"	3/4"	DM20096*12	3.50 (88.90)	1.48 (37.59)	1.75 (44.45)	0.94 (23.88)	2.00 (50.80)	3/8"-16	1.84 (0.83)
1"	1"	DM20096*16	4.50 (114.30)	1.82 (46.23)	2.00 (50.80)	1.09 (27.69)	2.25 (57.15)	7/16"-14	2.83 (1.28)
1-1/4"	1-1/4"	DM20096*20	4.88 (123.95)	2.26 (57.40)	2.38 (60.45)	1.25 (31.75)	2.63 (66.80)	1/2"-13	4.42 (2.00)
1-1/2"	1-1/2"	DM20096*24	5.00 (127.00)	2.58 (65.53)	2.50 (63.50)	1.44 (36.58)	3.13 (79.50)	5/8"-11	6.47 (2.93)
2"	2"	DM20096*32	6.50 (165.10)	3.04 (77.22)	3.50 (88.90)	1.75 (44.45)	3.81 (96.77)	3/4"-10	10.17 (4.61)
**3"	3"	DM20096*48	9.50 (241.30)	4.38 (111.25)	5.00 (127.00)	2.44 (61.89)	4.19 (106.43)	1"-8	22.51 (10.21)

\*\*3" uses ISO 6164 Flange.

# DM 20 Series - NPS Pipe

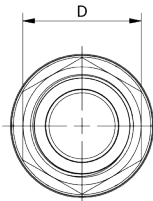
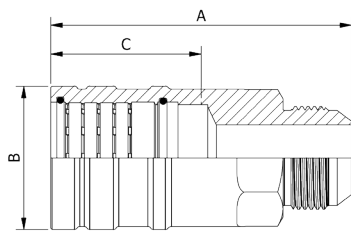

\*MATERIAL CODE:  
 K = STAINLESS STEEL  
 G = CARBON STEEL  
 B = COPPER NICKEL 70/30

ORDER EXAMPLE:  
 DM20055G04

## JIC 37° Male, NPS - DM20055

Size NPS	JIC Size	Part Number	Dimensions - Inch (mm)				*Weight K & G lbs (kg)
			A	B	C Insertion Depth	D	
1/4"	04	DM20055*04	2.25 (57.15)	0.80 (20.32)	1.13 (28.70)	0.50 (12.70)	0.10 (0.05)
3/8"	06	DM20055*06	2.63 (66.80)	0.99 (25.15)	1.38 (35.05)	0.63 (16.00)	0.21 (0.10)
1/2"	08	DM20055*08	3.25 (82.55)	1.20 (30.48)	1.50 (38.10)	0.81 (20.57)	0.37 (0.17)
3/4"	12	DM20055*12	3.69 (93.73)	1.48 (37.59)	1.75 (44.45)	1.13 (28.70)	0.63 (0.29)
1"	16	DM20055*16	4.00 (101.60)	1.82 (46.23)	2.00 (50.80)	1.38 (35.05)	1.06 (0.48)
1-1/4"	20	DM20055*20	4.75 (120.65)	2.26 (57.40)	2.38 (60.45)	1.88 (47.75)	2.11 (0.96)
1-1/2"	24	DM20055*24	4.75 (120.65)	2.58 (65.53)	2.50 (63.50)	2.25 (57.15)	2.66 (1.21)
2"	32	DM20055*32	6.00 (152.40)	3.04 (77.22)	3.50 (88.90)	2.63 (66.80)	4.08 (1.85)

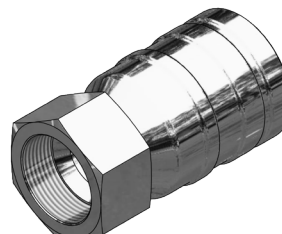
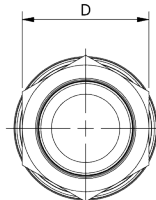
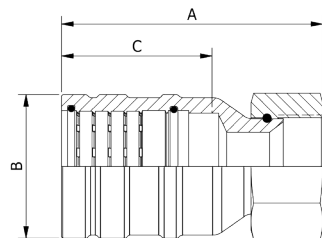

\*MATERIAL CODE:  
 K = STAINLESS STEEL  
 G = CARBON STEEL  
 B = COPPER NICKEL 70/30

ORDER EXAMPLE:  
 DM20054G04

## JIC 37° Female Swivel, NPS - DM20054

Size NPS	JIC Size	Part Number	Dimensions - Inch (mm)				*Weight K & G lbs (kg)
			A	B	C Insertion Depth	D	
1/4"	04	DM20054*04	2.23 (56.64)	0.80 (20.32)	1.13 (28.70)	0.56 (14.22)	0.12 (0.05)
3/8"	06	DM20054*06	2.67 (67.82)	0.99 (25.15)	1.38 (35.05)	0.69 (17.53)	0.21 (0.10)
1/2"	08	DM20054*08	3.07 (77.98)	1.20 (30.48)	1.50 (38.10)	0.88 (22.35)	0.37 (0.17)
3/4"	12	DM20054*12	3.40 (86.36)	1.48 (37.59)	1.75 (44.45)	1.25 (31.75)	0.74 (0.34)
1"	16	DM20054*16	4.05 (102.87)	1.82 (46.23)	2.00 (50.80)	1.50 (38.10)	1.19 (0.54)
1-1/4"	20	DM20054*20	4.40 (111.76)	2.26 (57.40)	2.38 (60.45)	2.00 (50.80)	2.15 (0.98)
1-1/2"	24	DM20054*24	4.77 (121.16)	2.58 (65.53)	2.50 (63.50)	2.25 (57.15)	3.00 (1.36)
2"	32	DM20054*32	5.99 (152.15)	3.04 (77.22)	3.50 (88.90)	2.88 (73.15)	4.53 (2.05)

3D step models available upon request

# DM 20 Series - NPS Pipe

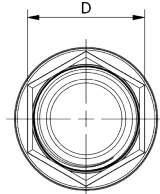
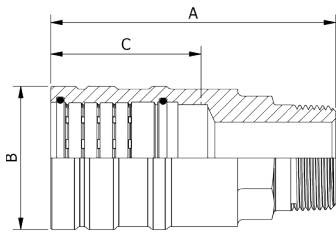

\*MATERIAL CODE:  
 K = STAINLESS STEEL  
 G = CARBON STEEL  
 B = COPPER NICKEL 70/30

ORDER EXAMPLE:  
 DM20056G04

## NPT Male, NPS - DM20056

Size NPS	NPT Size	Part Number	Dimensions - Inch (mm)				*Weight K & G lbs (kg)
			A	B	C Insertion Depth	D	
1/4"	1/4"	DM20056*04	2.25 (57.15)	0.80 (20.32)	1.13 (28.70)	0.56 (14.22)	0.12 (0.05)
3/8"	3/8"	DM20056*06	2.63 (66.80)	0.99 (25.15)	1.38 (35.05)	0.75 (19.05)	0.21 (0.10)
1/2"	1/2"	DM20056*08	3.25 (82.55)	1.20 (30.48)	1.50 (38.10)	0.88 (22.35)	0.40 (0.18)
3/4"	3/4"	DM20056*12	3.50 (88.90)	1.48 (37.59)	1.75 (44.45)	1.25 (31.75)	0.76 (0.34)
1"	1"	DM20056*16	4.00 (101.6)	1.82 (46.23)	2.00 (50.80)	1.50 (38.10)	1.20 (0.54)
1-1/4"	1-1/4"	DM20056*20	4.50 (63.50)	2.26 (57.40)	2.38 (60.45)	2.39 (60.71)	2.07 (0.94)
1-1/2"	1-1/2"	DM20056*24	4.75 (120.65)	2.58 (65.53)	2.50 (63.50)	2.13 (54.10)	2.50 (1.13)
2"	2"	DM20056*32	6.00 (152.40)	3.04 (77.22)	3.50 (88.90)	2.63 (66.80)	4.41 (2.00)

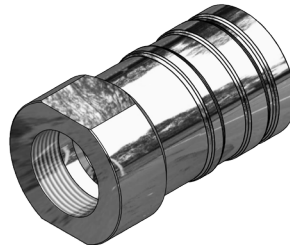
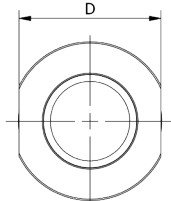
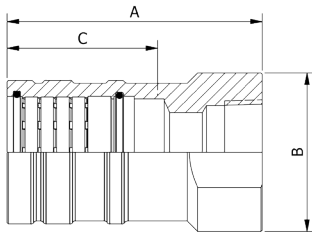

\*MATERIAL CODE:  
 K = STAINLESS STEEL  
 G = CARBON STEEL  
 B = COPPER NICKEL 70/30

ORDER EXAMPLE:  
 DM20060G04

## NPT Female, NPS - DM20060

Size NPS	NPT Size	Part Number	Dimensions - Inch (mm)				*Weight K & G lbs (kg)
			A	B	C Insertion Depth	D	
1/4"	1/4"	DM20060*04	2.00 (50.80)	1.00 (25.40)	1.13 (28.70)	0.88 (22.35)	0.20 (0.09)
3/8"	3/8"	DM20060*06	2.25 (57.15)	1.25 (31.75)	1.38 (35.05)	1.00 (25.40)	0.32 (0.15)
1/2"	1/2"	DM20060*08	2.75 (69.85)	1.38 (35.05)	1.50 (38.10)	1.25 (31.75)	0.48 (0.22)
3/4"	3/4"	DM20060*12	3.25 (82.55)	1.75 (44.45)	1.75 (44.45)	1.50 (38.10)	0.90 (0.41)
1"	1"	DM20060*16	3.63 (92.20)	1.98 (50.29)	2.00 (50.80)	1.88 (47.75)	1.40 (0.63)
1-1/4"	1-1/4"	DM20060*20	4.03 (102.36)	2.50 (63.50)	2.38 (60.45)	2.25 (57.15)	2.20 (1.00)
1-1/2"	1-1/2"	DM20060*24	4.38 (111.25)	3.00 (76.20)	2.50 (63.50)	2.74 (69.60)	3.53 (1.60)
2"	2"	DM20060*32	5.50 (139.70)	3.50 (88.90)	3.50 (88.90)	3.00 (76.20)	4.80 (2.17)

# DM 20 Series - NPS Pipe

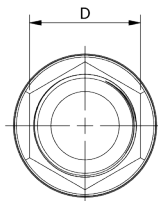
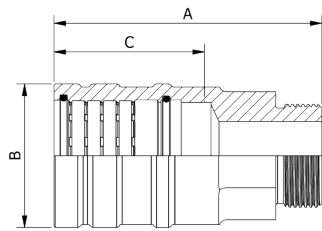

**\*MATERIAL CODE:**  
 K = STAINLESS STEEL  
 G = CARBON STEEL  
 B = COPPER NICKEL 70/30

**ORDER EXAMPLE:**  
 DM20088G04

## SAE Male, NPS - DM20088

Size NPS	SAE Size	Part Number	Dimensions - Inch (mm)				*Weight K & G lbs (kg)
			A	B	C Insertion Depth	D	
1/4"	04	DM20088*04	2.18 (55.37)	0.80 (20.32)	1.13 (28.70)	0.50 (12.70)	0.12 (0.05)
3/8"	06	DM20088*06	2.47 (62.74)	0.99 (25.15)	1.38 (35.05)	0.69 (17.53)	0.20 (0.09)
1/2"	08	DM20088*08	2.74 (69.60)	1.20 (30.48)	1.50 (38.10)	0.88 (22.35)	0.33 (0.15)
3/4"	12	DM20088*12	3.35 (85.09)	1.48 (37.59)	1.75 (44.45)	1.13 (28.70)	0.61 (0.28)
1"	16	DM20088*16	3.73 (94.74)	1.82 (46.23)	2.00 (50.80)	1.50 (38.10)	1.09 (0.49)
1-1/4"	20	DM20088*20	4.23 (107.44)	2.26 (57.40)	2.38 (60.45)	1.88 (47.75)	1.87 (0.85)
1-1/2"	24	DM20088*24	4.48 (113.79)	2.58 (65.53)	2.50 (63.50)	2.13 (54.10)	2.56 (1.16)
2"	32	DM20088*32	5.35 (135.89)	3.04 (77.22)	3.50 (88.90)	2.75 (69.85)	3.84 (1.74)

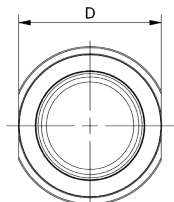
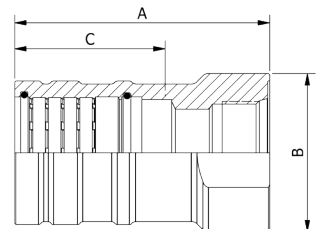

**\*MATERIAL CODE:**  
 K = STAINLESS STEEL  
 G = CARBON STEEL  
 B = COPPER NICKEL 70/30

**ORDER EXAMPLE:**  
 DM20087G04

## SAE Female, NPS - DM20087

Size NPS	SAE Size	Part Number	Dimensions - Inch (mm)				*Weight K & G lbs (kg)
			A	B	C Insertion Depth	D	
1/4"	04	DM20087*04	2.00 (50.80)	0.88 (22.35)	1.13 (28.70)	0.75 (19.05)	0.16 (0.07)
3/8"	06	DM20087*06	2.38 (60.45)	1.00 (25.40)	1.38 (35.05)	0.88 (22.35)	0.26 (0.12)
1/2"	08	DM20087*08	2.63 (66.80)	1.25 (31.75)	1.50 (38.10)	1.13 (28.70)	0.42 (0.19)
3/4"	12	DM20087*12	3.25 (82.55)	1.75 (44.45)	1.75 (44.45)	1.50 (38.10)	0.90 (0.41)
1"	16	DM20087*16	3.60 (91.44)	1.98 (50.29)	2.00 (50.80)	1.75 (44.45)	1.27 (0.58)
1-1/4"	20	DM20087*20	4.03 (102.36)	2.50 (63.50)	2.38 (60.45)	2.25 (57.15)	1.96 (0.89)
1-1/2"	24	DM20087*24	4.35 (110.49)	2.75 (69.85)	2.50 (63.50)	2.50 (63.50)	2.80 (1.27)
2"	32	DM20087*32	5.75 (146.05)	3.50 (88.90)	3.50 (88.90)	3.25 (82.55)	5.09 (2.31)

3D step models available upon request

# DM 20 Series - NPS Pipe

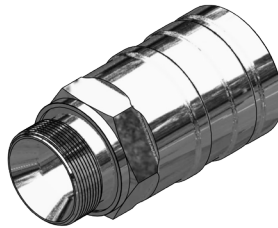
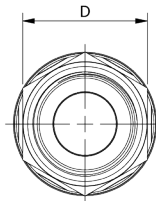
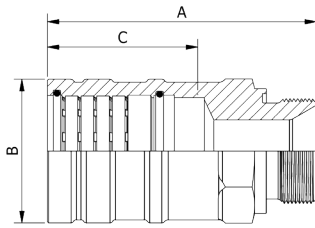

\*MATERIAL CODE:  
 K = STAINLESS STEEL  
 G = CARBON STEEL  
 B = COPPER NICKEL 70/30

ORDER EXAMPLE:  
 DM20153G04

## BSPP Male, NPS - DM20153

Size NPS	BSPP Size	Part Number	Dimensions - Inch (mm)				*Weight K & G lbs (kg)
			A	B	C Insertion Depth	D	
1/4"	1/4"	DM20153*04	2.13 (54.10)	0.80 (20.32)	1.13 (28.70)	0.75 (19.05)	0.14 (0.06)
3/8"	3/8"	DM20153*06	2.38 (60.45)	0.99 (25.15)	1.38 (35.05)	0.87 (22.10)	0.22 (0.10)
1/2"	1/2"	DM20153*08	3.00 (76.20)	1.20 (30.48)	1.50 (38.10)	1.18 (29.97)	0.46 (0.21)
3/4"	3/4"	DM20153*12	3.38 (85.85)	1.48 (37.59)	1.75 (44.45)	1.42 (36.07)	0.71 (0.32)
1"	1"	DM20153*16	3.63 (92.20)	1.82 (46.23)	2.00 (50.80)	1.81 (45.97)	1.14 (0.52)
1-1/4"	1-1/4"	DM20153*20	4.25 (107.95)	2.26 (57.40)	2.38 (60.45)	1.97 (50.04)	1.95 (0.88)
1-1/2"	1-1/2"	DM20153*24	4.63 (117.60)	2.58 (65.53)	2.50 (63.50)	2.17 (55.12)	2.67 (1.21)
2"	2"	DM20153*32	5.38 (136.65)	3.04 (77.22)	3.50 (88.90)	2.95 (74.93)	3.49 (1.58)

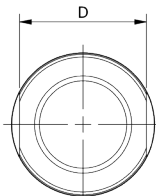
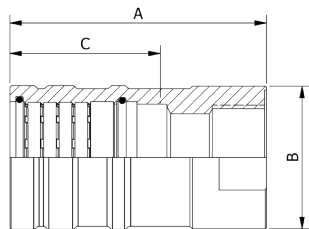

\*MATERIAL CODE:  
 K = STAINLESS STEEL  
 G = CARBON STEEL  
 B = COPPER NICKEL 70/30

ORDER EXAMPLE:  
 DM20086G04

## BSPP Female, NPS - DM20086

Size NPS	BSPP Size	Part Number	Dimensions - Inch (mm)				*Weight K & G lbs (kg)
			A	B	C Insertion Depth	D	
1/4"	1/4"	DM20086*04	2.00 (50.80)	0.88 (22.35)	1.13 (28.70)	0.75 (19.05)	0.15 (0.07)
3/8"	3/8"	DM20086*06	2.38 (60.45)	1.06 (26.92)	1.38 (35.05)	0.94 (23.88)	0.25 (0.11)
1/2"	1/2"	DM20086*08	2.63 (66.80)	1.25 (31.75)	1.50 (38.10)	1.06 (26.92)	0.40 (0.18)
3/4"	3/4"	DM20086*12	3.25 (82.55)	1.75 (44.45)	1.75 (44.45)	1.50 (38.10)	0.91 (0.41)
1"	1"	DM20086*16	3.50 (88.90)	2.00 (50.80)	2.00 (50.80)	1.75 (44.45)	1.28 (0.58)
1-1/4"	1-1/4"	DM20086*20	4.05 (102.87)	2.25 (57.15)	2.38 (60.45)	2.00 (50.80)	1.91 (0.87)
1-1/2"	1-1/2"	DM20086*24	4.38 (111.25)	2.75 (69.85)	2.50 (63.50)	2.50 (63.50)	2.88 (1.31)
2"	2"	DM20086*32	5.75 (146.05)	3.50 (88.90)	3.50 (88.90)	3.00 (76.20)	5.14 (2.33)

# DM 20 Series - NPS Pipe

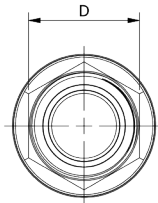
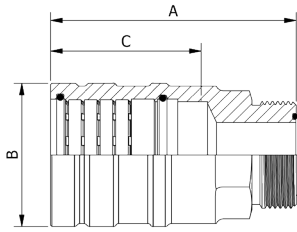

**\*MATERIAL CODE:**  
**K = STAINLESS STEEL**  
**G = CARBON STEEL**  
**B = COPPER NICKEL 70/30**

**ORDER EXAMPLE:**  
**DM20010G04**

## ORFS Male, NPS - DM20010

Size NPS	ORFS Size	Part Number	Dimensions - Inch (mm)				*Weight K & G lbs (kg)
			A	B	C Insertion Depth	D	
1/4"	04	DM20010*04	2.13 (54.10)	0.80 (20.32)	1.13 (28.70)	0.63 (16.00)	0.13 (0.06)
3/8"	06	DM20010*06	2.50 (63.50)	0.99 (25.15)	1.38 (35.05)	0.75 (19.05)	0.23 (0.10)
1/2"	08	DM20010*08	2.75 (69.85)	1.20 (30.48)	1.50 (38.10)	0.88 (22.35)	0.34 (0.15)
3/4"	12	DM20010*12	3.25 (82.55)	1.48 (37.59)	1.75 (44.45)	1.25 (31.75)	0.69 (0.31)
1"	16	DM20010*16	3.50 (88.90)	1.82 (46.23)	2.00 (50.80)	1.50 (38.10)	1.18 (0.54)
1-1/4"	20	DM20010*20	4.08 (103.63)	2.26 (57.40)	2.38 (60.45)	1.75 (44.45)	1.80 (0.82)
1-1/2"	24	DM20010*24	4.38 (111.25)	2.58 (65.53)	2.50 (63.50)	2.13 (54.10)	2.53 (1.15)

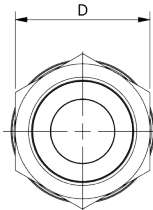
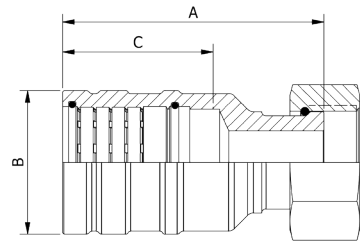

**\*MATERIAL CODE:**  
**K = STAINLESS STEEL**  
**G = CARBON STEEL**  
**B = COPPER NICKEL 70/30**

**ORDER EXAMPLE:**  
**DM20020G04**

## ORFS Female Swivel, NPS - DM20020

Size NPS	ORFS Size	Part Number	Dimensions - Inch (mm)				*Weight K & G lbs (kg)
			A	B	C Insertion Depth	D	
1/4"	04	DM20020*04	2.25 (57.15)	0.80 (20.32)	1.13 (28.70)	0.67 (17.02)	0.14 (0.06)
3/8"	06	DM20020*06	2.50 (63.50)	0.99 (25.15)	1.38 (35.05)	0.86 (21.84)	0.26 (0.12)
1/2"	08	DM20020*08	2.75 (69.85)	1.20 (30.48)	1.50 (38.10)	0.94 (23.88)	0.33 (0.15)
3/4"	12	DM20020*12	3.50 (88.90)	1.48 (37.59)	1.75 (44.45)	1.63 (41.40)	1.04 (0.47)
1"	16	DM20020*16	3.63 (92.20)	1.82 (46.23)	2.00 (50.80)	1.75 (44.45)	1.31 (0.59)
1-1/4"	20	DM20020*20	4.13 (104.90)	2.26 (57.40)	2.38 (60.45)	2.13 (54.10)	2.21 (1.00)
1-1/2"	24	DM20020*24	4.38 (111.25)	2.58 (65.53)	2.50 (63.50)	2.38 (60.45)	2.95 (1.34)

3D step models available upon request



# DM 20 Series - NPS Pipe

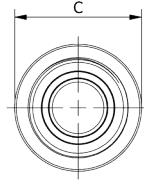
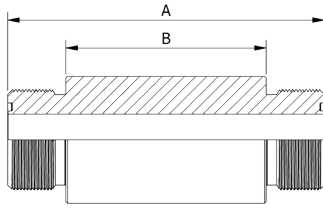

**\*MATERIAL CODE:**  
 K = STAINLESS STEEL  
 G = CARBON STEEL  
 B = COPPER NICKEL 70/30

**ORDER EXAMPLE:**  
 DM60089G08

## Weldable Bulkhead, OD Tube - DM60089

Size NPS	ORFS Size	Part Number	Dimensions - Inch (mm)			Thread Details	*Weight K & G lbs (kg)
			A	B	C		
1/2"	08	DM60089*08	3.00 (76.20)	1.99 (50.55)	1.00 (25.40)	13/16"-16UNF-2A	0.49 (0.22)
3/4"	12	DM60089*12	3.75 (95.25)	2.37 (60.20)	1.50 (38.10)	1-3/16"-12UNF-2A	1.31 (0.59)
1"	16	DM60089*16	3.75 (95.25)	2.37 (60.20)	1.75 (44.45)	1-7/16"-12UNF-2A	1.70 (0.77)
1-1/4"	20	DM60089*20	4.00 (101.60)	2.62 (66.55)	2.00 (50.80)	1-11/16"-12UNF-2A	2.28 (1.03)
1-1/2"	24	DM60089*24	4.25 (107.95)	2.87 (72.90)	2.38 (60.45)	2"-12UNF-2A	2.89 (1.31)

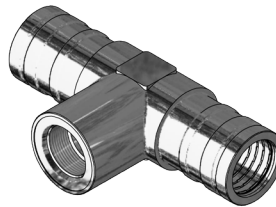
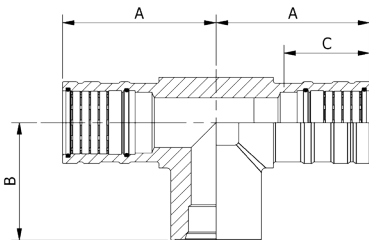

**\*MATERIAL CODE:**  
 K = STAINLESS STEEL  
 G = CARBON STEEL  
 B = COPPER NICKEL 70/30

**ORDER EXAMPLE:**  
 DM20171G04

## SAE Female Branch Tee, NPS - DM20171

Size NPS	SAE Size	Part Number	Dimensions - Inch (mm)				*Weight K & G lbs (kg)
			A	B	C Insertion Depth	D	
1/4"	04	DM20171*04	1.75 (44.45)	1.38 (35.05)	1.13 (28.70)	0.86 (21.84)	0.41 (0.19)
3/8"	06	DM20171*06	2.00 (50.80)	1.63 (41.40)	1.38 (35.05)	1.06 (26.92)	0.71 (0.32)
1/2"	08	DM20171*08	2.68 (68.07)	2.25 (57.15)	1.50 (38.10)	1.30 (33.02)	1.44 (0.65)
3/4"	12	DM20171*12	3.03 (76.96)	2.50 (63.50)	1.75 (44.45)	1.58 (40.13)	2.26 (1.03)
1"	16	DM20171*16	3.37 (85.60)	2.88 (73.15)	2.00 (50.80)	1.97 (50.04)	3.83 (1.74)
1-1/4"	20	DM20171*20	4.25 (107.95)	3.25 (82.55)	2.38 (60.45)	2.50 (63.50)	7.40 (3.36)
1-1/2"	24	DM20171*24	4.54 (115.32)	3.50 (88.90)	2.50 (63.50)	2.81 (71.37)	10.06 (4.56)
2"	32	DM20171*32	5.45 (138.43)	4.00 (101.60)	3.50 (88.90)	3.25 (82.55)	14.11 (6.40)

# DM 20 Series - NPS Pipe

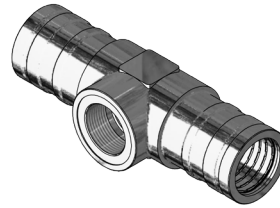
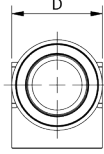
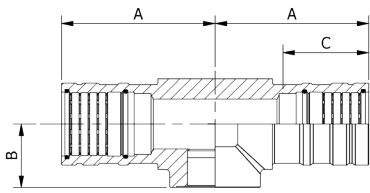

**\*MATERIAL CODE:**  
 K = STAINLESS STEEL  
 G = CARBON STEEL  
 B = COPPER NICKEL 70/30

**ORDER EXAMPLE:**  
 DM20172G04

## BSPP Female Branch Tee, NPS - DM20172

Size NPS	BSPP Size	Part Number	Dimensions - Inch (mm)				*Weight K & G lbs (kg)
			A	B	C Insertion Depth	D	
1/4"	1/4"	DM20172*04	1.75 (44.45)	1.00 (25.40)	1.13 (28.70)	0.86 (21.84)	0.33 (0.15)
3/8"	3/8"	DM20172*06	2.00 (50.80)	1.00 (25.40)	1.38 (35.05)	1.06 (26.92)	0.54 (0.24)
1/2"	1/2"	DM20172*08	2.68 (68.07)	1.25 (31.75)	1.50 (38.10)	1.30 (33.02)	1.06 (0.48)
3/4"	3/4"	DM20172*12	3.03 (76.96)	1.25 (31.75)	1.75 (44.45)	1.58 (40.13)	1.60 (0.73)
1"	1"	DM20172*16	3.37 (85.60)	1.50 (38.10)	2.00 (50.80)	1.97 (50.04)	2.80 (1.27)
1-1/4"	1-1/4"	DM20172*20	4.25 (107.95)	1.75 (44.45)	2.38 (60.45)	2.50 (63.50)	5.89 (2.67)
1-1/2"	1-1/2"	DM20172*24	4.54 (115.32)	2.00 (50.80)	2.50 (63.50)	2.69 (68.33)	7.11 (3.23)
2"	2"	DM20172*32	5.45 (138.43)	2.38 (60.45)	3.50 (88.90)	3.25 (82.55)	10.48 (4.75)

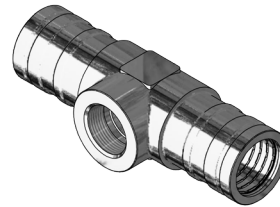
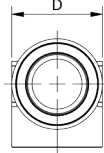
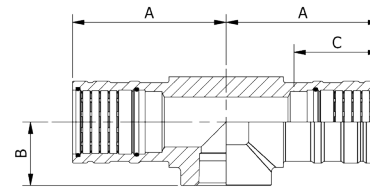

**\*MATERIAL CODE:**  
 K = STAINLESS STEEL  
 G = CARBON STEEL  
 B = COPPER NICKEL 70/30

**ORDER EXAMPLE:**  
 DM20173G04

## NPT Female Branch Tee, NPS - DM20173













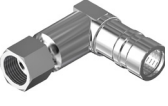







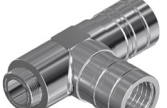

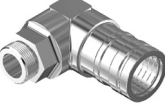





Size NPS	NPT Size	Part Number	Dimensions - Inch (mm)				*Weight K & G lbs (kg)
			A	B	C Insertion Depth	D	
1/4"	1/4"	DM20173*04	1.75 (44.45)	0.75 (19.05)	1.13 (28.70)	0.86 (21.84)	0.31 (0.14)
3/8"	3/8"	DM20173*06	2.00 (50.80)	1.00 (25.40)	1.38 (35.05)	1.06 (26.92)	0.56 (0.25)
1/2"	1/2"	DM20173*08	2.68 (68.07)	1.13 (28.70)	1.50 (38.10)	1.30 (33.02)	1.10 (0.50)
3/4"	3/4"	DM20173*12	3.03 (76.96)	1.25 (31.75)	1.75 (44.45)	1.58 (40.13)	1.70 (0.77)
1"	1"	DM20173*16	3.37 (85.60)	1.38 (35.05)	2.00 (50.80)	1.97 (50.04)	2.80 (1.27)
1-1/4"	1-1/4"	DM20173*20	4.25 (107.95)	1.75 (44.45)	2.38 (60.45)	2.50 (63.50)	5.70 (2.59)
1-1/2"	1-1/2"	DM20173*24	4.54 (115.32)	2.00 (50.80)	2.50 (63.50)	2.81 (71.37)	7.85 (3.56)
2"	2"	DM20173*32	5.45 (138.43)	2.00 (50.80)	3.50 (88.90)	3.25 (82.55)	13.60 (6.17)

3D step models available upon request

# Specialty Fitting Configuration Guide

## DM 20 Series - NPS Pipe

1/4" to 3"

					
<b>JIC 37° 90° Elbow Male</b> DM20355	<b>JIC 37° Branch Tee Male</b> DM20177	<b>JIC 37° Run Tee Male</b> DM20178	<b>JIC 37° 90° Elbow Female Swivel</b> DM20354	<b>JIC 37° Branch Tee Female Swivel</b> DM20170	<b>NPT 90° Elbow Male</b> DM20057
					
<b>NPT Branch Tee Male</b> DM20176	<b>NPT Run Tee Male</b> DM20181	<b>NPT 90° Elbow Female</b> DM20061	<b>ORFS 90° Elbow Male</b> DM20011	<b>ORFS Branch Tee Male</b> DM20013	<b>ORFS Run Tee Male</b> DM20014
					
<b>ORFS 90° Elbow Female Swivel</b> DM20021	<b>ORFS Branch Tee Female Swivel</b> DM20023	<b>SAE 90° Elbow Male</b> DM20105	<b>SAE Branch Tee Male</b> DM20174	<b>SAE Run Tee Male</b> DM20179	<b>SAE 90° Elbow Female</b> DM20387
					
<b>BSPP 90° Elbow Male</b> DM20168	<b>BSPP Branch Tee Male</b> DM20175	<b>BSPP Run Tee Male</b> DM20180	<b>BSPP 90° Elbow Female</b> DM20169	<b>BSPP Cross Fitting with 2 Ports</b> DM20221	<b>BSPP Cross Fitting with 4 Ports</b> DM20241
					
<b>Flange - ANSI #900</b> DM20025	<b>Flange - ANSI #1500</b> DM20026	<b>Compact Elbow x Code 61 Flange</b> DM20231	<b>Compact Elbow x Code 62 Flange</b> DM20232	<b>90° PYPLOK® x SAE Code 61 Flange</b> DM20391	<b>90° PYPLOK® x SAE Code 62 Flange</b> DM20392

# Specialty Fitting Configuration Guide

## DM 20 Series - NPS Pipe

1/4" to 3"

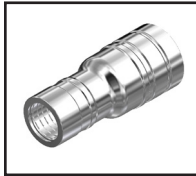

**NPS to OD Tube Reducer**  
DM20501



**NPS to Metric Tube Reducer**  
DM20801



**CPV Female**  
DM20040



**CPV Male Union**  
DM20041



**Extra Long Coupling**  
DM20301

Introduction

Technical Information

DM 20 – NPS Pipe

DM 60 – OD Tube

DM 80 – Metric Tube

DM Series Thread Adapter

DM 80 – Metric & JIS Tube

DP 40N – NPS Low Pressure

DP40M – Metric Low Pressure

PYPLOK® Tooling

Installation Procedures

Appendix



# General Characteristics

## DM 60 Series – OD Tube

### Fitting Material Specifications      Material Specification

K = Stainless Steel	ASTM-A479/A182-316
G = Carbon Steel	ASTM-A105/A350 LF2
B = Copper Nickel 70/30	MIL-C71500
C = Copper Nickel 90/10	MIL-C70600
D = Duplex	ASTM-A479/A182-UNS31803
Z = Super Duplex	ASTM-A479/A182-UNS32750

### O-Ring Material Specifications      O-Ring Temperature Limits

VITON (Brown Colour)	-15°F to 400°F (-26°C to 205°C)
EPDM (Black Colour)	-60°F to 400°F (-51°C to 205°C)

For seal compatibility and selection for each system consult factory. Other seal materials for specific applications of compatibility and temperature are available upon request.

### Ordering Information

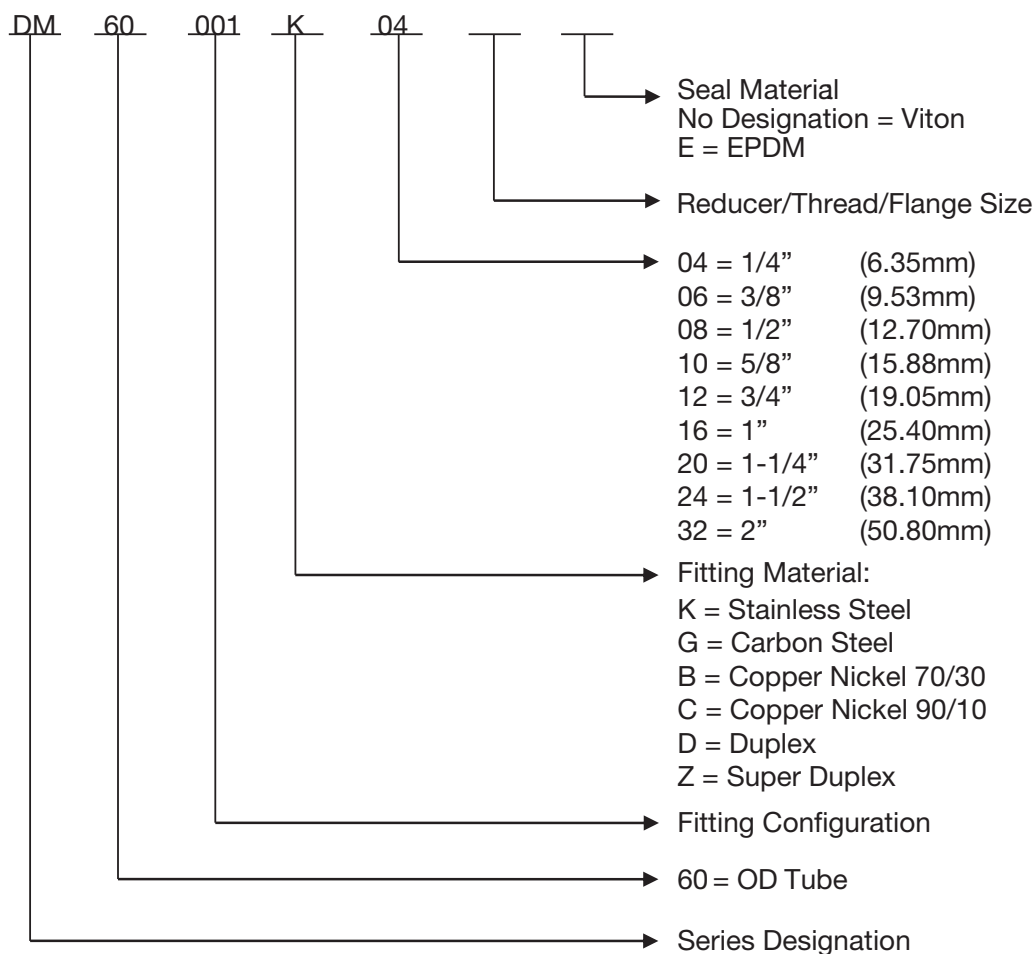



System design and safe application is the responsibility of the end-user. Consideration must be taken to confirm proper fitting selection is made to ensure proper compatibility, function and operation of the fitting within the piping system. The technical and performance information such as weights, dimensions and ratings in this catalogue supersede all previous published data. Tube-Mac® reserves the right to change technical data and product dimension, ratings and other aspects without notice.

# Standard Fitting Configuration Guide

## DM 60 Series - OD Tube

1/4" to 2"

					
<b>Coupling</b> DM60001 Page D3	<b>Coupling with Inner Stop</b> DM60002 Page D3	<b>90° Elbow</b> DM60003 Page D4	<b>45° Elbow</b> DM60017 Page D4	<b>Tee</b> DM60004 Page D5	<b>Reducing Tee</b> DM60104 Page D6
					
<b>Reducer</b> DM60101 Page D7	<b>End Cap</b> DM60085 Page D8	<b>Flange - ANSI 150#</b> DM60018 Page D9	<b>Flange - ANSI 300#</b> DM60019 Page D9	<b>Flange - ANSI 600#</b> DM60027 Page D10	<b>SAE Flange Body</b> DM60090 Page D10
					
<b>SAE Code 61 Flange</b> DM60091 Page D11	<b>SAE Code 62 Flange</b> DM60092 Page D11	<b>SAE Code 61 Tapped Flange</b> DM60095 Page D12	<b>SAE Code 62 Tapped Flange</b> DM60096 Page D12	<b>JIC 37° Male</b> DM60055 Page D13	<b>JIC 37° Female Swivel</b> DM60054 Page D13
					
<b>NPT Male</b> DM60056 Page D14	<b>NPT Female</b> DM60060 Page D14	<b>SAE Male</b> DM60088 Page D15	<b>SAE Female</b> DM60087 Page D15	<b>BSPP Male</b> DM60153 Page D16	<b>BSPP Female</b> DM60086 Page D16
					
<b>ORFS Male</b> DM60010 Page D17	<b>ORFS Female Swivel</b> DM60020 Page D17	<b>Weldable Bulkhead</b> DM60089 Page D18	<b>SAE Female Branch Tee</b> DM60171 Page D18	<b>BSPP Female Branch Tee</b> DM60172 Page D19	<b>NPT Female Branch Tee</b> DM60173 Page D19

# DM 60 Series – OD Tube

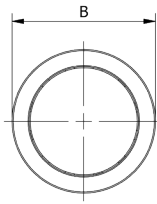
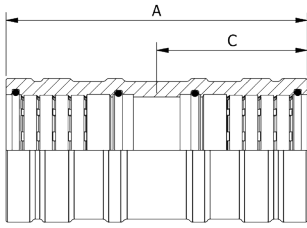

**\*MATERIAL CODE:**  
 K = STAINLESS STEEL  
 G = CARBON STEEL  
 B = COPPER NICKEL 70/30

**ORDER EXAMPLE:**  
 DM60001G04

## Coupling, OD Tube - DM60001

Size OD	Part Number	Dimensions - Inch (mm)			*Weight K & G lbs (kg)
		A	B	C Insertion Depth	
1/4"	DM60001*04	1.51 (38.35)	0.39 (9.91)	0.75 (19.05)	0.02 (0.01)
3/8"	DM60001*06	1.84 (46.74)	0.55 (13.97)	0.92 (23.37)	0.05 (0.02)
1/2"	DM60001*08	2.18 (55.37)	0.75 (19.05)	1.09 (27.69)	0.11 (0.05)
5/8"	DM60001*10	2.52 (64.01)	0.93 (23.62)	1.26 (32.00)	0.21 (0.10)
3/4"	DM60001*12	2.85 (72.39)	1.09 (27.69)	1.42 (36.07)	0.30 (0.14)
1"	DM60001*16	3.41 (86.61)	1.41 (35.81)	1.70 (43.18)	0.61 (0.28)
1-1/4"	DM60001*20	3.88 (98.55)	1.73 (43.94)	1.94 (49.28)	1.04 (0.47)
1-1/2"	DM80001*38	4.29 (108.97)	2.05 (52.07)	2.15 (54.61)	1.57 (0.71)
2"	DM60001*32	5.00 (127.00)	2.58 (65.53)	2.50 (63.50)	2.49 (1.13)

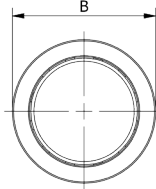
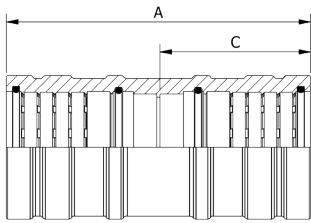

**\*MATERIAL CODE:**  
 K = STAINLESS STEEL  
 G = CARBON STEEL  
 B = COPPER NICKEL 70/30

**ORDER EXAMPLE:**  
 DM60002G04

## Coupling with Inner Stop, OD Tube - DM60002

Size OD	Part Number	Dimensions - Inch (mm)			*Weight K & G lbs (kg)
		A	B	C Insertion Depth	
1/4"	DM60002*04	1.56 (39.52)	0.39 (9.91)	0.75 (19.05)	0.02 (0.01)
3/8"	DM60002*06	1.89 (47.96)	0.55 (13.97)	0.92 (23.37)	0.05 (0.02)
1/2"	DM60002*08	2.23 (56.59)	0.75 (19.05)	1.09 (27.69)	0.11 (0.05)
5/8"	DM60002*10	2.57 (65.28)	0.93 (23.62)	1.26 (32.00)	0.21 (0.10)
3/4"	DM60002*12	2.90 (73.56)	1.09 (27.69)	1.42 (36.07)	0.30 (0.14)
1"	DM60002*16	3.46 (87.78)	1.41 (35.81)	1.70 (43.18)	0.61 (0.28)
1-1/4"	DM60002*20	3.93 (99.85)	1.73 (43.94)	1.94 (49.28)	1.04 (0.47)
1-1/2"	DM80002*38	4.34 (110.24)	2.05 (52.07)	2.15 (54.61)	1.57 (0.71)
2"	DM60002*32	5.05 (128.27)	2.58 (65.53)	2.50 (63.50)	2.49 (1.13)

3D step models available upon request



# DM 60 Series – OD Tube

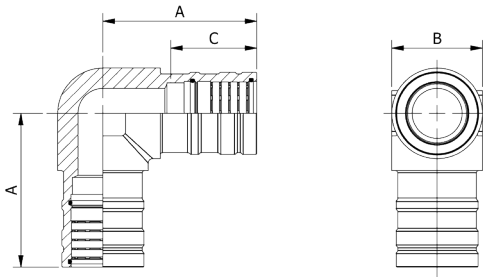

**\*MATERIAL CODE:**  
 K = STAINLESS STEEL  
 G = CARBON STEEL  
 B = COPPER NICKEL 70/30

**ORDER EXAMPLE:**  
 DM60003G04

## 90° Elbow, OD Tube - DM60003

Size OD	Part Number	Dimensions - Inch (mm)			*Weight K & G lbs (kg)
		A	B	C Insertion Depth	
1/4"	DM60003*04	1.20 (30.43)	0.47 (11.94)	0.75 (19.05)	0.05 (0.02)
3/8"	DM60003*06	1.50 (38.10)	0.63 (16.00)	0.92 (23.37)	0.12 (0.05)
1/2"	DM60003*08	1.75 (44.45)	0.86 (21.84)	1.09 (27.69)	0.26 (0.12)
5/8"	DM60003*10	2.00 (50.80)	1.06 (26.92)	1.26 (32.00)	0.47 (0.21)
3/4"	DM60003*12	2.68 (68.07)	1.30 (33.02)	1.42 (36.07)	0.91 (0.41)
1"	DM60003*16	3.03 (76.96)	1.58 (40.13)	1.70 (43.18)	1.54 (0.70)
1-1/4"	DM60003*20	3.40 (86.36)	1.97 (50.04)	1.94 (49.28)	2.70 (1.22)
1-1/2"	DM80003*38	4.25 (107.95)	2.50 (63.50)	2.15 (54.61)	5.42 (2.46)
2"	DM60003*32	4.54 (115.32)	2.81 (71.37)	2.50 (63.50)	6.85 (3.11)

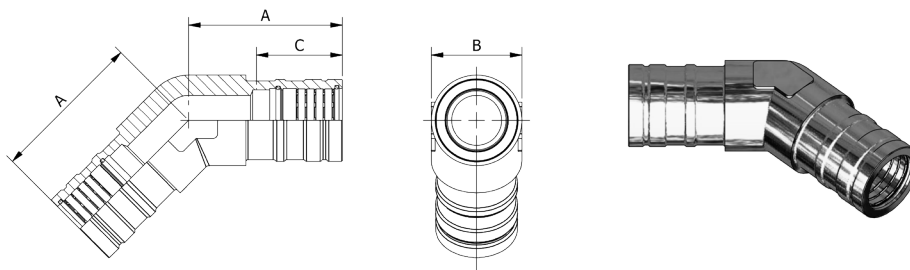

**\*MATERIAL CODE:**  
 K = STAINLESS STEEL  
 G = CARBON STEEL  
 B = COPPER NICKEL 70/30

**ORDER EXAMPLE:**  
 DM60017G04

## 45° Elbow, OD Tube - DM60017

Size OD	Part Number	Dimensions - Inch (mm)			*Weight K & G lbs (kg)
		A	B	C Insertion Depth	
1/4"	DM60017*04	1.20 (30.43)	0.47 (11.94)	0.75 (19.05)	0.05 (0.02)
3/8"	DM60017*06	1.50 (38.10)	0.63 (16.00)	0.92 (23.37)	0.12 (0.05)
1/2"	DM60017*08	1.75 (44.45)	0.86 (21.84)	1.09 (27.69)	0.27 (0.12)
5/8"	DM60017*10	2.00 (50.80)	1.06 (26.92)	1.26 (32.00)	0.48 (0.22)
3/4"	DM60017*12	2.68 (68.07)	1.30 (33.02)	1.42 (36.07)	0.92 (0.42)
1"	DM60017*16	3.03 (76.96)	1.58 (40.13)	1.70 (43.18)	1.57 (0.71)
1-1/4"	DM60017*20	3.40 (86.36)	1.97 (50.04)	1.94 (49.28)	2.76 (1.25)
1-1/2"	DM80017*38	4.25 (107.95)	2.50 (63.50)	2.15 (54.61)	5.08 (2.30)
2"	DM60017*32	4.54 (115.32)	2.81 (71.37)	2.50 (63.50)	7.17 (3.25)

# DM 60 Series – OD Tube

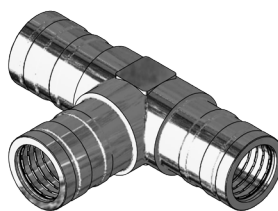
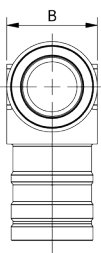
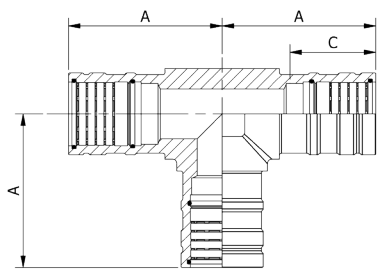

**\*MATERIAL CODE:**  
**K = STAINLESS STEEL**  
**G = CARBON STEEL**  
**B = COPPER NICKEL 70/30**

**ORDER EXAMPLE:**  
**DM60004G04**

## Tee, OD Tube - DM60004

Size OD	Part Number	Dimensions - Inch (mm)			*Weight K & G lbs (kg)
		A	B	C Insertion Depth	
1/4"	DM60004*04	1.20 (30.43)	0.47 (11.94)	0.75 (19.05)	0.07 (0.03)
3/8"	DM60004*06	1.50 (38.10)	0.63 (16.00)	0.92 (23.37)	0.16 (0.07)
1/2"	DM60004*08	1.75 (44.45)	0.86 (21.84)	1.09 (27.69)	0.35 (0.16)
5/8"	DM60004*10	2.00 (50.80)	1.06 (26.92)	1.26 (32.00)	0.63 (0.29)
3/4"	DM60004*12	2.68 (68.07)	1.30 (33.02)	1.42 (36.07)	1.22 (0.55)
1"	DM60004*16	3.03 (76.96)	1.58 (40.13)	1.70 (43.18)	2.08 (0.94)
1-1/4"	DM60004*20	3.40 (86.36)	1.97 (50.04)	1.94 (49.28)	3.48 (1.58)
1-1/2"	DM80004*38	4.25 (107.95)	2.50 (63.50)	2.15 (54.61)	6.61 (3.00)
2"	DM60004*32	4.54 (115.32)	2.81 (71.37)	2.50 (63.50)	9.19 (4.17)

Introduction

Technical Information

DM 20 – NPS Pipe

DM 60 – OD Tube

DM 80 – Metric Tube

DM Series Thread Adapter

DM 80 – Metric & JIS Tube

DP 40N – NPS Low Pressure

DP40M – Metric Low Pressure

PYPLOK® Tooling

Installation Procedures

Appendix

# DM 60 Series – OD Tube

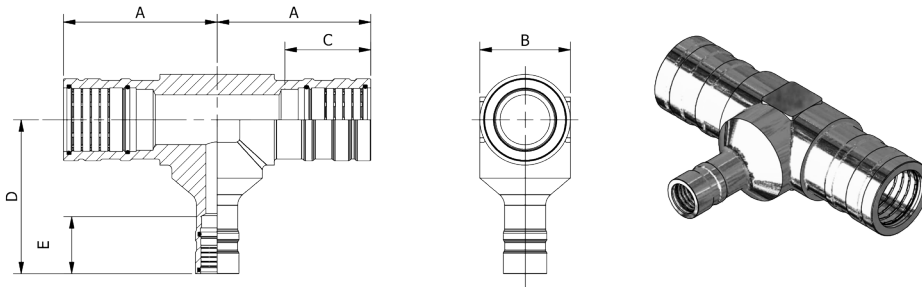

**\*MATERIAL CODE:**  
 K = STAINLESS STEEL  
 G = CARBON STEEL  
 B = COPPER NICKEL 70/30

**ORDER EXAMPLE:**  
 DM60104G0604

Other configurations available.  
 Contact factory for details.

## Reducing Tee, OD Tube - DM60104

Run Size OD	Branch Size OD	Part Number	Dimensions - Inch (mm)					*Weight K & G lbs (kg)
			A	B	C Insertion Depth	D	E Insertion Depth	
3/8"	1/4"	DM60104*0604	1.50 (38.10)	0.63 (16.00)	0.92 (23.37)	1.50 (38.10)	0.75 (19.05)	0.16 (0.07)
1/2"	1/4"	DM60104*0804	1.75 (44.45)	0.86 (21.84)	1.09 (27.69)	1.75 (44.45)	0.75 (19.05)	0.34 (0.15)
1/2"	3/8"	DM60104*0806	1.75 (44.45)	0.86 (21.84)	1.09 (27.69)	1.75 (44.45)	0.92 (23.37)	0.33 (0.15)
5/8"	3/8"	DM60104*1006	2.00 (50.80)	1.06 (26.92)	1.26 (32.00)	1.75 (44.45)	0.92 (23.37)	0.55 (0.25)
5/8"	1/2"	DM60104*1008	2.00 (50.80)	1.06 (26.92)	1.26 (32.00)	2.00 (50.80)	1.09 (27.69)	0.59 (0.27)
3/4"	5/8"	DM60104*1210	2.68 (68.07)	1.30 (33.02)	1.42 (36.07)	2.68 (68.07)	1.26 (32.00)	1.16 (0.53)
1"	1/2"	DM60104*1608	3.03 (76.96)	1.58 (40.13)	1.70 (43.18)	3.03 (76.96)	1.09 (27.69)	2.05 (0.93)
1"	5/8"	DM60104*1610	3.03 (76.96)	1.58 (40.13)	1.70 (43.18)	3.03 (76.96)	1.26 (32.00)	2.03 (0.92)
1"	3/4"	DM60104*1612	3.03 (76.96)	1.58 (40.13)	1.70 (43.18)	3.03 (76.96)	1.42 (36.07)	1.92 (0.87)
1-1/4"	1/2"	DM60104*2008	3.40 (86.36)	1.97 (50.04)	1.94 (49.28)	3.03 (76.95)	1.09 (27.69)	3.46 (1.57)
1-1/4"	3/4"	DM60104*2012	3.40 (86.36)	1.97 (50.04)	1.94 (49.28)	3.37 (85.60)	1.42 (36.07)	3.27 (1.48)
1-1/4"	1"	DM60104*2016	3.40 (86.36)	1.97 (50.04)	1.94 (49.28)	3.37 (85.60)	1.70 (43.18)	3.42 (1.55)
1-1/2"	3/4"	DM60104*2412	4.25 (107.95)	2.50 (63.50)	2.15 (54.61)	3.75 (95.25)	1.42 (36.07)	6.77 (3.07)
1-1/2"	1"	DM60104*2416	4.25 (107.95)	2.50 (63.50)	2.15 (54.61)	4.25 (107.95)	1.70 (43.18)	6.84 (3.10)
1-1/2"	1-1/4"	DM60104*2420	4.25 (107.95)	2.50 (63.50)	2.15 (54.61)	4.25 (107.95)	1.94 (49.28)	6.85 (3.11)
2"	1"	DM60104*3216	4.54 (115.32)	2.81 (71.37)	2.50 (63.50)	4.54 (115.32)	1.70 (43.18)	8.90 (4.04)
2"	1-1/4"	DM60104*3220	4.54 (115.32)	2.81 (71.37)	2.50 (63.50)	4.54 (115.32)	1.94 (49.28)	9.02 (4.09)
2"	1-1/2"	DM60104*3224	4.54 (115.32)	2.81 (71.37)	2.50 (63.50)	4.54 (115.32)	2.20 (55.88)	8.95 (4.06)

# DM 60 Series – OD Tube

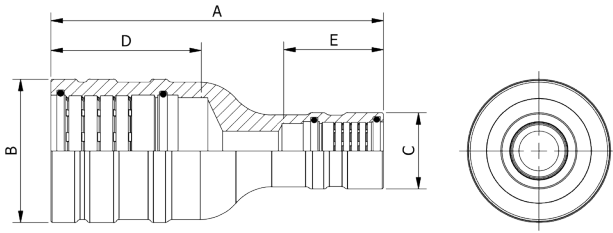

**\*MATERIAL CODE:**  
 K = STAINLESS STEEL  
 G = CARBON STEEL  
 B = COPPER NICKEL 70/30

**ORDER EXAMPLE:**  
 DM60101G0604

Other configurations available.  
 Contact factory for details.

## Reducer, OD Tube - DM60101

End 1 Size OD	End 2 Size OD	Part Number	Dimensions - Inch (mm)					*Weight K & G lbs (kg)
			A	B	C	D Insertion Depth	E Insertion Depth	
3/8"	1/4"	DM60101*0604	2.00 (50.80)	0.55 (13.97)	0.39 (9.91)	0.92 (23.37)	0.75 (19.05)	0.04 (0.02)
1/2"	1/4"	DM60101*0804	2.25 (57.15)	0.75 (19.05)	0.39 (9.91)	1.09 (27.69)	0.75 (19.05)	0.08 (0.04)
1/2"	3/8"	DM60101*0806	2.38 (60.45)	0.75 (19.05)	0.55 (13.97)	1.09 (27.69)	0.92 (23.37)	0.09 (0.04)
5/8"	3/8"	DM60101*1006	2.88 (73.15)	0.93 (23.62)	0.55 (13.97)	1.26 (32.00)	0.92 (23.37)	0.15 (0.07)
5/8"	1/2"	DM60101*1008	2.88 (73.15)	0.93 (23.62)	0.75 (19.05)	1.26 (32.00)	1.09 (27.69)	0.16 (0.07)
3/4"	1/2"	DM60101*1208	3.50 (88.90)	1.09 (27.69)	0.75 (19.05)	1.42 (36.07)	1.09 (27.69)	0.28 (0.13)
3/4"	5/8"	DM60101*1210	3.50 (88.90)	1.09 (27.69)	0.93 (23.62)	1.42 (36.07)	1.26 (32.00)	0.33 (0.15)
1"	5/8"	DM60101*1610	3.63 (92.20)	1.41 (35.81)	0.93 (23.62)	1.70 (43.18)	1.26 (32.00)	0.53 (0.24)
1"	3/4"	DM60101*1612	4.25 (107.95)	1.41 (35.81)	1.09 (27.69)	1.70 (43.18)	1.42 (36.07)	0.62 (0.28)
1-1/4"	3/4"	DM60101*2012	4.50 (114.30)	1.73 (43.94)	1.09 (27.69)	1.94 (49.28)	1.42 (36.07)	0.87 (0.39)
1-1/4"	1"	DM60101*2016	4.50 (114.30)	1.73 (43.94)	1.41 (35.81)	1.94 (49.28)	1.70 (43.18)	1.05 (0.48)
1-1/2"	1"	DM60101*2416	5.00 (127.00)	2.05 (52.07)	1.41 (35.81)	2.15 (54.61)	1.70 (43.18)	1.55 (0.70)
1-1/2"	1-1/4"	DM60101*2420	5.00 (127.00)	2.05 (52.07)	1.73 (43.94)	2.15 (54.61)	1.94 (49.28)	1.65 (0.75)
2"	1-1/4"	DM60101*3220	5.75 (146.05)	2.58 (65.53)	1.73 (43.94)	2.50 (63.50)	1.94 (49.28)	2.59 (1.17)
2"	1-1/2"	DM60101*3224	6.00 (152.40)	2.58 (65.53)	2.06 (52.32)	2.50 (63.50)	2.20 (55.88)	2.90 (1.32)

# DM 60 Series – OD Tube

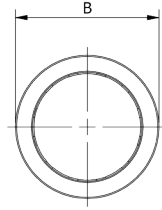
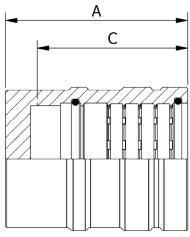

*\*MATERIAL CODE:  
K = STAINLESS STEEL  
G = CARBON STEEL  
B = COPPER NICKEL 70/30*

*ORDER EXAMPLE:  
DM60085G04*

## End Cap, OD Tube - DM60085

Size OD	Part Number	Dimensions - Inch (mm)			*Weight K & G lbs (kg)
		A	B	C Insertion Depth	
1/4"	<b>DM60085*04</b>	1.00 (25.40)	0.39 (9.91)	0.75 (19.05)	0.02 (0.01)
3/8"	<b>DM60085*06</b>	1.25 (31.75)	0.55 (13.97)	0.92 (23.37)	0.04 (0.02)
1/2"	<b>DM60085*08</b>	1.38 (35.05)	0.75 (19.05)	1.09 (27.69)	0.08 (0.04)
5/8"	<b>DM60085*10</b>	1.50 (38.10)	0.93 (23.62)	1.26 (32.00)	0.13 (0.06)
3/4"	<b>DM60085*12</b>	1.75 (44.45)	1.09 (27.69)	1.42 (36.07)	0.21 (0.10)
1"	<b>DM60085*16</b>	2.25 (57.15)	1.41 (35.81)	1.70 (43.18)	0.50 (0.23)
1-1/4"	<b>DM60085*20</b>	2.38 (60.45)	1.73 (43.94)	1.94 (49.28)	0.75 (0.34)
1-1/2"	<b>DM80085*38</b>	2.63 (66.80)	2.05 (52.07)	2.15 (54.61)	1.36 (0.62)
2"	<b>DM60085*32</b>	3.00 (76.20)	2.58 (65.53)	2.50 (63.50)	1.80 (0.82)

# DM 60 Series – OD Tube

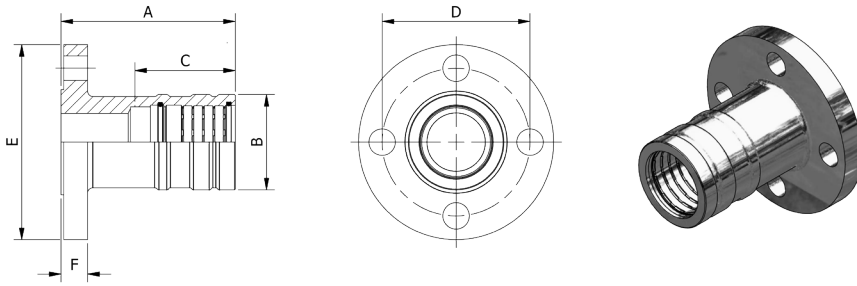

**\*MATERIAL CODE:**  
**K = STAINLESS STEEL**  
**G = CARBON STEEL**  
**B = COPPER NICKEL 70/30**

**ORDER EXAMPLE:**  
**DM60018G08**

## Flange – ANSI 150#, OD Tube - DM60018

Size OD	Flange Size	Part Number	Dimensions - Inch (mm)						Bolt Size	*Weight K & G lbs (kg)
			A	B	C Insertion Depth	D	E	F		
1/2"	1/2"	<b>DM60018*08</b>	2.38 (60.45)	0.75 (19.05)	1.09 (27.69)	2.38 (60.45)	3.50 (88.90)	0.44 (11.18)	1/2" UNC	1.06 (0.48)
3/4"	3/4"	<b>DM60018*12</b>	3.13 (79.50)	1.09 (27.69)	1.42 (36.07)	2.75 (69.85)	3.88 (98.55)	0.50 (12.70)	1/2" UNC	1.69 (0.77)
1"	1"	<b>DM60018*16</b>	3.63 (92.20)	1.41 (35.81)	1.70 (43.18)	3.12 (79.25)	4.25 (107.95)	0.56 (14.22)	1/2" UNC	2.73 (1.24)
1-1/4"	1-1/4"	<b>DM60018*20</b>	4.00 (101.60)	1.73 (43.94)	1.94 (49.28)	3.50 (88.90)	4.62 (117.35)	0.63 (16.00)	1/2" UNC	3.51 (1.59)
1-1/2"	1-1/2"	<b>DM60018*24</b>	4.25 (107.95)	2.05 (52.07)	2.15 (54.61)	3.88 (98.55)	5.00 (127.00)	0.75 (19.05)	1/2" UNC	4.98 (2.26)
2"	2"	<b>DM60018*32</b>	5.50 (139.70)	2.58 (65.53)	2.50 (63.50)	4.75 (120.65)	6.00 (152.40)	0.75 (19.05)	5/8" UNC	7.66 (3.47)

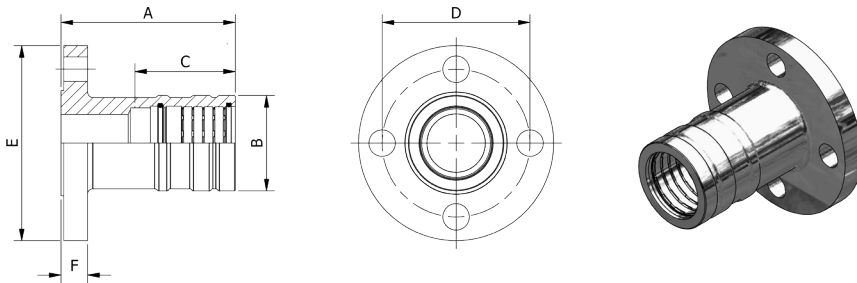

**\*MATERIAL CODE:**  
**K = STAINLESS STEEL**  
**G = CARBON STEEL**  
**B = COPPER NICKEL 70/30**

**ORDER EXAMPLE:**  
**DM60019G08**

## Flange – ANSI 300#, OD Tube - DM60019

Size OD	Flange Size	Part Number	Dimensions - Inch (mm)						Bolt Size	*Weight K & G lbs (kg)
			A	B	C Insertion Depth	D	E	F		
1/2"	1/2"	<b>DM60019*08</b>	2.88 (73.15)	0.75 (19.05)	1.09 (27.69)	2.63 (66.80)	3.75 (95.25)	0.56 (14.22)	1/2" UNC	1.67 (0.76)
3/4"	3/4"	<b>DM60019*12</b>	3.75 (95.25)	1.09 (27.69)	1.42 (36.07)	3.25 (82.55)	4.62 (117.35)	0.63 (16.00)	5/8" UNC	3.00 (1.36)
1"	1"	<b>DM60019*16</b>	3.88 (98.55)	1.41 (35.81)	1.70 (43.18)	3.50 (88.90)	4.88 (123.95)	0.69 (17.53)	5/8" UNC	3.79 (1.72)
1-1/4"	1-1/4"	<b>DM60019*20</b>	4.25 (107.95)	1.73 (43.94)	1.94 (49.28)	3.88 (98.55)	5.25 (133.35)	0.75 (19.05)	5/8" UNC	5.07 (2.30)
1-1/2"	1-1/2"	<b>DM60019*24</b>	4.50 (114.30)	2.05 (52.07)	2.20 (55.88)	4.50 (114.30)	6.12 (155.45)	0.81 (20.57)	3/4" UNC	7.37 (3.34)
**2"	2"	<b>DM60019*32</b>	5.13 (130.30)	2.58 (65.53)	2.50 (63.50)	5.00 (127.00)	6.50 (165.10)	0.88 (22.35)	5/8" UNC	9.09 (4.12)

\*\*2" ANSI 300# Flange has 8 Bolts.

3D step models available upon request

# DM 60 Series – OD Tube

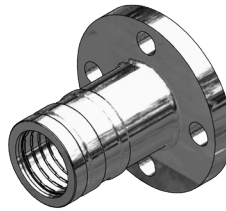
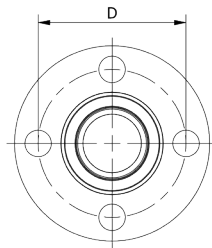
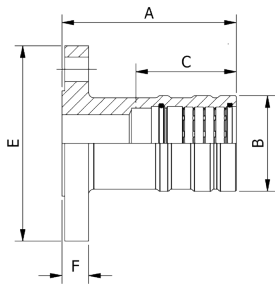

**\*MATERIAL CODE:**  
 K = STAINLESS STEEL  
 G = CARBON STEEL  
 B = COPPER NICKEL 70/30

**ORDER EXAMPLE:**  
 DM60027G08

## Flange – ANSI 600#, OD Tube - DM60027

Size OD	Flange Size	Part Number	Dimensions - Inch (mm)						Bolt Size	*Weight K & G lbs (kg)
			A	B	C Insertion Depth	D	E	F		
1/2"	1/2"	DM60027*08	3.13 (79.50)	0.75 (19.05)	1.09 (27.69)	2.63 (66.80)	3.75 (95.25)	0.81 (20.57)	1/2" UNC	1.92 (0.87)
3/4"	3/4"	DM60027*12	3.75 (95.25)	1.09 (27.69)	1.42 (36.07)	3.25 (82.55)	4.63 (117.60)	0.88 (22.35)	5/8" UNC	3.31 (1.51)
1"	1"	DM60027*16	3.88 (98.55)	1.41 (35.81)	1.70 (43.18)	3.50 (88.90)	4.88 (123.95)	0.94 (23.88)	5/8" UNC	4.31 (1.51)
1-1/4"	1-1/4"	DM60027*20	4.50 (114.30)	1.73 (43.94)	1.94 (49.28)	3.88 (98.55)	5.25 (133.35)	1.06 (26.92)	5/8" UNC	6.04 (2.74)
1-1/2"	1-1/2"	DM60027*24	4.63 (117.60)	2.05 (52.07)	2.15 (54.61)	4.50 (98.55)	6.13 (155.70)	1.13 (28.70)	3/4" UNC	8.45 (3.83)
2"	2"	DM60027*32	5.75 (146.05)	2.58 (65.53)	2.50 (63.50)	5.00 (127.00)	6.50 (165.10)	1.25 (31.75)	5/8" UNC	10.41 (4.72)

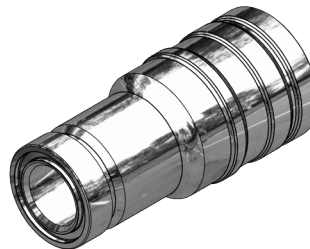
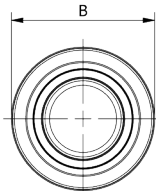
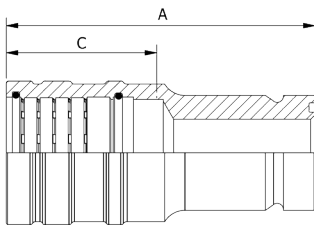

**\*MATERIAL CODE:**  
 K = STAINLESS STEEL  
 G = CARBON STEEL  
 B = COPPER NICKEL 70/30

**ORDER EXAMPLE:**  
 DM60090G08

## SAE Flange Body, OD Tube - DM60090

Size OD	Flange Size	Part Number	Dimensions - Inch (mm)			*Weight K & G lbs (kg)
			A	B	C Insertion Depth	
1/2"	1/2"	DM60090*08	2.50 (63.50)	0.75 (19.05)	1.09 (27.69)	0.28 (0.13)
3/4"	3/4"	DM60090*12	3.38 (85.85)	1.09 (27.69)	1.42 (36.07)	0.66 (0.30)
1"	1"	DM60090*16	3.50 (88.90)	1.41 (35.81)	1.70 (43.18)	0.87 (0.39)
1-1/4"	1-1/4"	DM60090*20	4.00 (101.60)	1.73 (43.94)	1.94 (49.28)	2.23 (1.01)
1-1/2"	1-1/2"	DM80090*3824	4.43 (112.52)	2.05 (52.07)	2.15 (54.61)	2.13 (0.97)
2"	2"	DM60090*32	5.63 (143.00)	2.58 (65.53)	2.50 (63.50)	3.49 (1.58)

# DM 60 Series – OD Tube

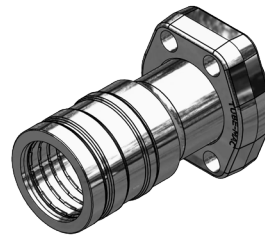
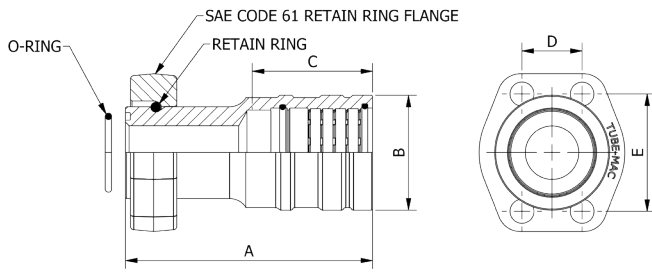

**\*MATERIAL CODE:**  
 K = STAINLESS STEEL  
 G = CARBON STEEL  
 B = COPPER NICKEL 70/30

**ORDER EXAMPLE:**  
 DM60091G08

## SAE Code 61 Flange, OD Tube - DM60091

Size OD	Flange Size	Part Number	Dimensions - Inch (mm)					Bolt Minimum Grade 8	*Weight K & G lbs (kg)
			A	B	C Insertion Depth	D	E		
1/2"	1/2"	DM60091*08	2.50 (63.50)	0.75 (19.05)	1.09 (27.69)	0.69 (17.53)	1.50 (38.10)	5/16" UNC	0.74 (0.34)
3/4"	3/4"	DM60091*12	3.38 (85.85)	1.09 (27.69)	1.42 (36.07)	0.88 (22.35)	1.88 (47.75)	3/8" UNC	1.16 (0.53)
1"	1"	DM60091*16	3.50 (88.90)	1.41 (35.81)	1.70 (43.18)	1.03 (26.16)	2.06 (52.32)	3/8" UNC	1.50 (0.68)
1-1/4"	1-1/4"	DM60091*20	4.00 (101.60)	1.73 (43.94)	1.94 (49.28)	1.19 (30.23)	2.31 (58.67)	7/16" UNC	3.13 (1.42)
1-1/2"	1-1/2"	DM80091*3824	4.50 (114.30)	2.05 (52.07)	2.15 (54.61)	1.41 (35.81)	2.75 (69.85)	1/2" UNC	3.48 (1.58)
2"	2"	DM60091*32	5.63 (143.00)	2.58 (65.53)	2.50 (63.50)	1.69 (42.93)	3.06 (77.72)	1/2" UNC	5.51 (2.50)

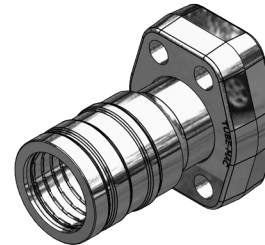
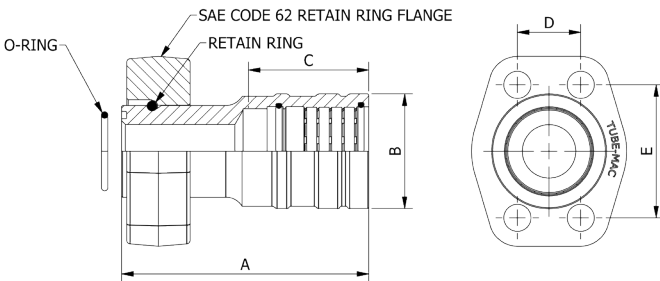

**\*MATERIAL CODE:**  
 K = STAINLESS STEEL  
 G = CARBON STEEL  
 B = COPPER NICKEL 70/30

**ORDER EXAMPLE:**  
 DM60092G08

## SAE Code 62 Flange, OD Tube - DM60092

Size OD	Flange Size	Part Number	Dimensions - Inch (mm)					Bolt Minimum Grade 8	*Weight K & G lbs (kg)
			A	B	C Insertion Depth	D	E		
1/2"	1/2"	DM60092*08	2.50 (63.50)	0.75 (19.05)	1.09 (27.69)	0.72 (18.29)	1.59 (40.39)	5/16" UNC	0.74 (0.34)
3/4"	3/4"	DM60092*12	3.38 (85.85)	1.09 (27.69)	1.42 (36.07)	0.94 (23.88)	2.00 (50.80)	3/8" UNC	1.47 (0.67)
1"	1"	DM60092*16	3.50 (88.90)	1.41 (35.81)	1.70 (43.18)	1.09 (27.69)	2.25 (57.15)	7/16" UNC	2.13 (0.97)
1-1/4"	1-1/4"	DM60092*20	4.00 (101.60)	1.73 (43.94)	1.94 (49.28)	1.25 (31.75)	2.62 (66.50)	1/2" UNC	4.18 (1.90)
1-1/2"	1-1/2"	DM80092*3824	4.50 (114.30)	2.05 (52.07)	2.15 (54.61)	1.44 (36.58)	3.13 (79.50)	5/8" UNC	5.01 (2.27)
2"	2"	DM60092*32	5.63 (143.00)	2.58 (65.53)	2.50 (63.50)	1.75 (44.45)	3.81 (96.77)	3/4" UNC	8.89 (4.03)



# DM 60 Series – OD Tube

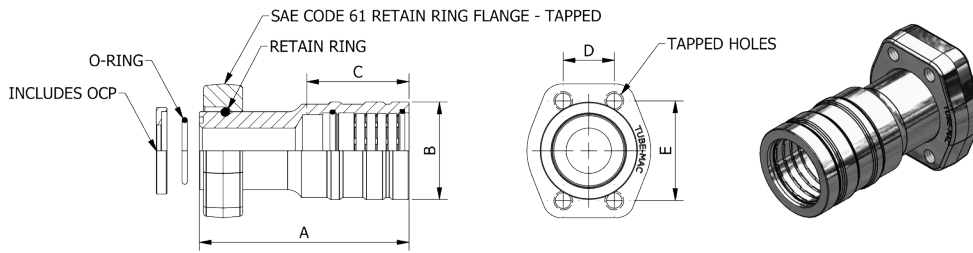

\*MATERIAL CODE:  
 K = STAINLESS STEEL  
 G = CARBON STEEL  
 B = COPPER NICKEL 70/30

ORDER EXAMPLE:  
 DM60095G08

## SAE Code 61 Tapped Flange, OD Tube - DM60095

Size OD	Flange Size	Part Number	Dimensions - Inch (mm)					Tap UNC-2B	*Weight K & G lbs (kg)
			A	B	C Insertion Depth	D	E		
1/2"	1/2"	DM60095*08	2.50 (63.50)	0.75 (19.05)	1.09 (27.69)	0.69 (17.53)	1.50 (38.10)	5/16"-18	0.74 (0.34)
3/4"	3/4"	DM60095*12	3.38 (85.85)	1.09 (27.69)	1.42 (36.07)	0.88 (22.35)	1.88 (47.75)	3/8"-16	1.16 (0.53)
1"	1"	DM60095*16	3.50 (88.90)	1.41 (35.81)	1.70 (43.18)	1.03 (26.16)	2.06 (52.32)	3/8"-16	1.50 (0.68)
1-1/4"	1-1/4"	DM60095*20	4.00 (101.60)	1.73 (43.94)	1.94 (49.28)	1.19 (30.23)	2.31 (58.67)	7/16"-14	3.13 (1.42)
1-1/2"	1-1/2"	DM60095*24	4.50 (114.30)	2.05 (52.07)	2.15 (54.61)	1.41 (35.81)	2.75 (69.85)	1/2"-13	3.48 (1.58)
2"	2"	DM60095*32	5.63 (143.00)	2.58 (65.53)	2.50 (63.50)	1.69 (42.93)	3.06 (77.72)	1/2"-13	5.51 (2.50)

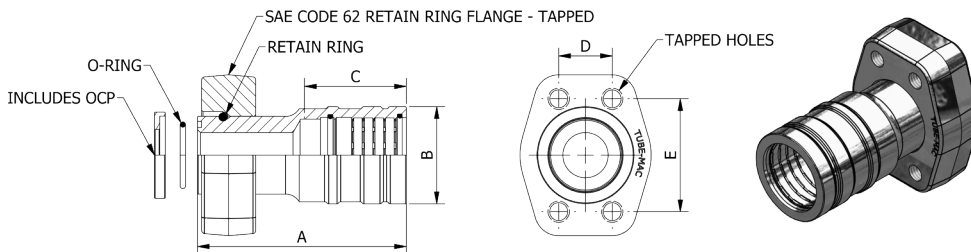

\*MATERIAL CODE:  
 K = STAINLESS STEEL  
 G = CARBON STEEL  
 B = COPPER NICKEL 70/30

ORDER EXAMPLE:  
 DM60096G08

## SAE Code 62 Tapped Flange, OD Tube - DM60096

Size OD	Flange Size	Part Number	Dimensions - Inch (mm)					Tap UNC-2B	*Weight K & G lbs (kg)
			A	B	C Insertion Depth	D	E		
1/2"	1/2"	DM60096*08	2.50 (63.50)	0.75 (19.05)	1.09 (27.69)	0.72 (18.29)	1.59 (40.39)	5/16"-18	0.74 (0.34)
3/4"	3/4"	DM60096*12	3.38 (85.85)	1.09 (27.69)	1.42 (36.07)	0.94 (23.88)	2.00 (50.80)	3/8"-16	1.47 (0.67)
1"	1"	DM60096*16	3.50 (88.90)	1.41 (35.81)	1.70 (43.18)	1.09 (27.69)	2.25 (57.15)	7/16"-14	2.13 (0.97)
1-1/4"	1-1/4"	DM60096*20	4.00 (101.60)	1.73 (43.94)	1.94 (49.28)	1.25 (31.75)	2.62 (66.50)	1/2"-13	4.18 (1.90)
1-1/2"	1-1/2"	DM60096*24	4.50 (114.30)	2.05 (52.07)	2.15 (54.61)	1.44 (36.58)	3.13 (79.50)	5/8"-11	5.01 (2.27)
2"	2"	DM60096*32	5.63 (143.00)	2.58 (65.53)	2.50 (63.50)	1.75 (44.45)	3.81 (96.77)	3/4"-10	8.89 (4.03)

# DM 60 Series – OD Tube

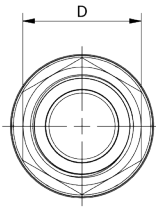
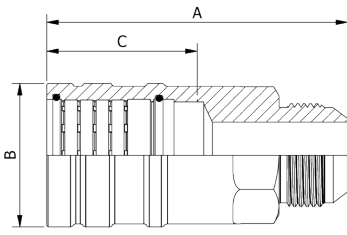

**\*MATERIAL CODE:**  
**K = STAINLESS STEEL**  
**G = CARBON STEEL**  
**B = COPPER NICKEL 70/30**

**ORDER EXAMPLE:**  
**DM60055G04**

## JIC 37° Male, OD Tube - DM60055

Size OD	JIC Size	Part Number	Dimensions - Inch (mm)				*Weight K & G lbs (kg)
			A	B	C Insertion Depth	D	
1/4"	04	DM60055*04	1.75 (44.45)	0.39 (9.91)	0.75 (19.05)	0.50 (12.70)	0.04 (0.02)
3/8"	06	DM60055*06	2.06 (52.32)	0.55 (13.97)	0.92 (23.37)	0.63 (16.00)	0.08 (0.04)
1/2"	08	DM60055*08	2.44 (61.98)	0.75 (19.05)	1.09 (27.69)	0.81 (20.57)	0.18 (0.08)
5/8"	10	DM60055*10	2.75 (69.85)	0.93 (23.62)	1.26 (32.00)	0.94 (23.88)	0.28 (0.13)
3/4"	12	DM60055*12	3.38 (85.73)	1.09 (27.69)	1.42 (36.07)	1.13 (28.70)	0.46 (0.21)
1"	16	DM60055*16	3.81 (96.77)	1.41 (35.81)	1.70 (43.18)	1.38 (35.05)	0.79 (0.36)
1-1/4"	20	DM60055*20	4.04 (102.62)	1.73 (43.94)	1.94 (49.28)	1.88 (47.75)	1.31 (0.59)
1-1/2"	24	DM80055*3824	4.63 (118.40)	2.05 (52.07)	2.15 (54.61)	2.00 (50.80)	1.81 (0.82)
2"	32	DM60055*32	5.10 (129.54)	2.58 (65.53)	2.50 (63.50)	3.03 (76.99)	3.31 (1.50)

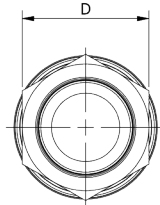
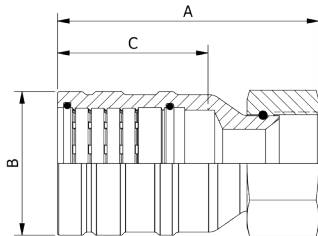

**\*MATERIAL CODE:**  
**K = STAINLESS STEEL**  
**G = CARBON STEEL**  
**B = COPPER NICKEL 70/30**

**ORDER EXAMPLE:**  
**DM60054G04**

## JIC 37° Female Swivel, OD Tube - DM60054

Size OD	JIC Size	Part Number	Dimensions - Inch (mm)				*Weight K & G lbs (kg)
			A	B	C Insertion Depth	D	
1/4"	04	DM60054*04	1.66 (42.16)	0.39 (9.91)	0.75 (19.05)	0.56 (14.22)	0.05 (0.02)
3/8"	06	DM60054*06	2.12 (53.85)	0.55 (13.97)	0.92 (23.37)	0.69 (17.53)	0.09 (0.04)
1/2"	08	DM60054*08	2.55 (64.77)	0.75 (19.05)	1.09 (27.69)	0.88 (22.35)	0.19 (0.09)
5/8"	10	DM60054*10	2.60 (66.04)	0.93 (23.62)	1.26 (32.00)	1.00 (25.40)	0.27 (0.12)
3/4"	12	DM60054*12	2.73 (69.34)	1.09 (27.69)	1.42 (36.07)	1.25 (31.75)	0.40 (0.18)
1"	16	DM60054*16	3.17 (80.52)	1.41 (35.81)	1.70 (43.18)	1.50 (38.10)	0.66 (0.30)
1-1/4"	20	DM60054*20	3.61 (91.69)	1.73 (43.94)	1.94 (49.28)	2.00 (50.80)	1.29 (0.59)
1-1/2"	24	DM80054*3824	4.50 (114.30)	2.05 (52.07)	2.15 (54.61)	2.25 (57.15)	2.10 (0.95)
2"	32	DM60054*32	4.95 (125.73)	2.58 (65.53)	2.50 (63.50)	2.88 (73.15)	3.33 (1.51)

3D step models available upon request

# DM 60 Series – OD Tube

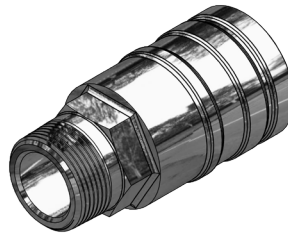
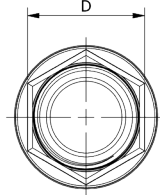
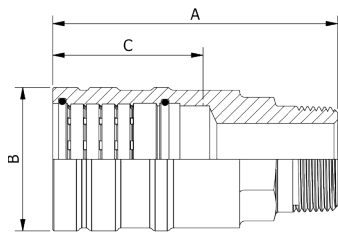

**\*MATERIAL CODE:**  
 K = STAINLESS STEEL  
 G = CARBON STEEL  
 B = COPPER NICKEL 70/30

**ORDER EXAMPLE:**  
 DM60056G04

## NPT Male, OD Tube - DM60056

Size OD	NPT Size	Part Number	Dimensions - Inch (mm)				*Weight K & G lbs (kg)
			A	B	C Insertion Depth	D	
1/4"	1/4"	DM60056*04	1.75 (44.45)	0.39 (9.91)	0.75 (19.05)	0.56 (14.22)	0.06 (0.03)
3/8"	3/8"	DM60056*06	2.06 (52.32)	0.55 (13.97)	0.92 (23.37)	0.75 (19.05)	0.12 (0.05)
1/2"	1/2"	DM60056*08	2.59 (65.79)	0.75 (19.05)	1.09 (27.69)	0.88 (22.35)	0.23 (0.10)
5/8"	1/2"	DM60056*1008	2.75 (69.85)	0.93 (23.62)	1.26 (32.00)	0.75 (19.05)	0.28 (0.13)
3/4"	3/4"	DM60056*12	3.25 (82.55)	1.09 (27.69)	1.42 (36.07)	1.25 (31.75)	0.52 (0.24)
1"	1"	DM60056*16	3.75 (95.25)	1.41 (35.81)	1.70 (43.18)	1.50 (38.10)	0.91 (0.41)
1-1/4"	1-1/4"	DM60056*20	3.88 (98.55)	1.73 (43.94)	1.94 (49.28)	1.75 (44.45)	1.31 (0.59)
1-1/2"	1-1/2"	DM60056*24	4.63 (117.60)	2.05 (52.07)	2.15 (54.61)	2.13 (54.10)	2.00 (0.91)
2"	2"	DM60056*32	4.63 (117.60)	2.58 (65.53)	2.50 (63.50)	2.63 (66.80)	2.62 (1.19)

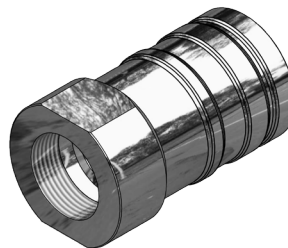
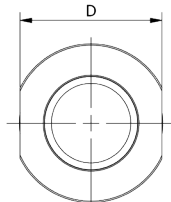
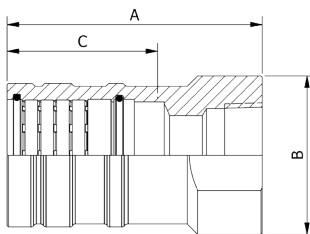

**\*MATERIAL CODE:**  
 K = STAINLESS STEEL  
 G = CARBON STEEL  
 B = COPPER NICKEL 70/30

**ORDER EXAMPLE:**  
 DM60060G04

## NPT Female, OD Tube - DM60060

Size OD	NPT Size	Part Number	Dimensions - Inch (mm)				*Weight K & G lbs (kg)
			A	B	C Insertion Depth	D	
1/4"	1/4"	DM60060*04	1.63 (41.40)	0.39 (9.91)	0.75 (19.05)	0.75 (19.05)	0.09 (0.04)
3/8"	3/8"	DM60060*06	2.00 (50.80)	0.55 (13.97)	0.92 (23.37)	0.88 (22.35)	0.14 (0.06)
1/2"	1/2"	DM60060*08	2.25 (57.15)	0.75 (19.05)	1.09 (27.69)	1.00 (25.40)	0.24 (0.11)
5/8"	1/2"	DM60060*1008	2.50 (63.50)	0.93 (23.62)	1.26 (32.00)	1.00 (25.40)	0.28 (0.13)
3/4"	3/4"	DM60060*12	3.00 (76.20)	1.09 (27.69)	1.42 (36.07)	1.38 (34.93)	0.46 (0.21)
1"	1"	DM60060*16	3.37 (85.60)	1.41 (35.81)	1.70 (43.18)	1.50 (38.10)	0.75 (0.35)
1-1/4"	1-1/4"	DM60060*20	3.63 (92.20)	1.73 (43.94)	1.94 (49.28)	2.00 (50.80)	1.22 (0.55)
1-1/2"	1-1/2"	DM60060*24	3.88 (98.55)	2.05 (52.07)	2.15 (54.61)	2.25 (57.15)	1.74 (0.79)
2"	2"	DM60060*32	4.13 (104.90)	2.58 (65.53)	2.50 (63.50)	2.75 (69.85)	2.34 (1.06)

# DM 60 Series – OD Tube

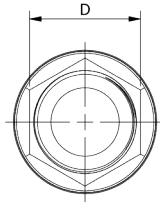
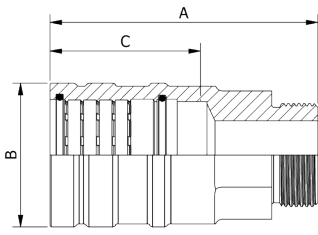

**\*MATERIAL CODE:**  
 K = STAINLESS STEEL  
 G = CARBON STEEL  
 B = COPPER NICKEL 70/30

**ORDER EXAMPLE:**  
 DM60088G04

## SAE Male, OD Tube - DM60088

Size OD	SAE Size	Part Number	Dimensions - Inch (mm)				*Weight K & G lbs (kg)
			A	B	C Insertion Depth	D	
1/4"	04	DM60088*04	1.50 (38.10)	0.39 (9.91)	0.75 (19.05)	0.56 (14.22)	0.04 (0.02)
3/8"	06	DM60088*06	2.00 (50.80)	0.55 (13.97)	0.92 (23.37)	0.69 (17.53)	0.09 (0.04)
1/2"	08	DM60088*08	2.25 (57.15)	0.75 (19.05)	1.09 (27.69)	0.88 (22.35)	0.17 (0.08)
5/8"	10	DM60088*10	2.50 (63.50)	0.93 (23.62)	1.26 (32.00)	1.00 (25.40)	0.26 (0.12)
3/4"	12	DM60088*12	3.25 (82.55)	1.09 (27.69)	1.42 (36.07)	1.25 (31.75)	0.50 (0.23)
1"	16	DM60088*16	3.38 (85.85)	1.41 (35.81)	1.70 (43.18)	1.50 (38.10)	0.76 (0.34)
1-1/4"	20	DM60088*20	3.88 (98.55)	1.73 (43.94)	1.94 (49.28)	1.88 (47.75)	1.31 (0.59)
1-1/2"	24	DM60088*24	4.25 (107.95)	2.06 (52.32)	2.15 (54.61)	2.13 (54.10)	1.90 (0.86)
2"	32	DM60088*32	4.38 (111.25)	2.58 (65.53)	2.50 (63.50)	2.75 (69.85)	2.64 (1.20)

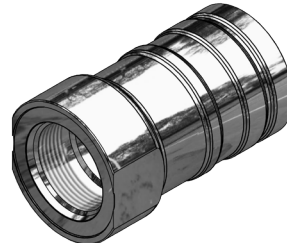
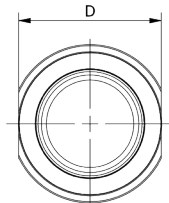
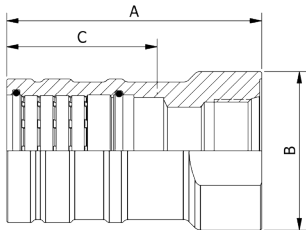

**\*MATERIAL CODE:**  
 K = STAINLESS STEEL  
 G = CARBON STEEL  
 B = COPPER NICKEL 70/30

**ORDER EXAMPLE:**  
 DM60087G04

## SAE Female, OD Tube - DM60087

Size OD	SAE Size	Part Number	Dimensions - Inch (mm)				*Weight K & G lbs (kg)
			A	B	C Insertion Depth	D	
1/4"	04	DM60087*04	1.75 (44.45)	0.88 (22.35)	0.75 (19.05)	0.75 (19.05)	0.11 (0.05)
3/8"	06	DM60087*06	2.00 (50.80)	1.25 (31.75)	0.92 (23.37)	0.88 (22.35)	0.16 (0.07)
1/2"	08	DM60087*08	2.50 (63.50)	1.25 (31.75)	1.09 (27.69)	1.13 (28.70)	0.26 (0.12)
5/8"	10	DM60087*10	2.75 (69.85)	1.50 (38.10)	1.26 (32.00)	1.13 (28.70)	0.45 (0.20)
3/4"	12	DM60087*12	3.38 (85.85)	1.75 (44.45)	1.42 (36.07)	1.50 (38.10)	0.70 (0.32)
1"	16	DM60087*16	3.50 (88.90)	1.98 (50.29)	1.70 (43.18)	1.75 (44.45)	1.00 (0.45)
1-1/4"	20	DM60087*20	3.88 (98.55)	2.50 (63.50)	1.94 (49.28)	2.25 (57.15)	1.73 (0.78)
1-1/2"	24	DM60087*24	4.75 (120.65)	2.75 (69.85)	2.15 (54.61)	2.50 (63.50)	2.83 (1.28)
2"	32	DM60087*32	5.00 (127.00)	3.63 (92.20)	2.50 (63.50)	3.25 (82.55)	4.35 (1.97)

3D step models available upon request

# DM 60 Series – OD Tube

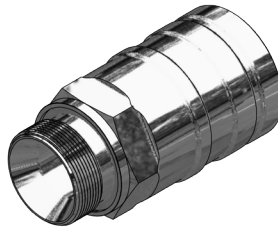
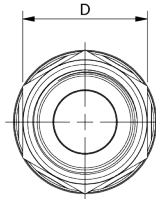
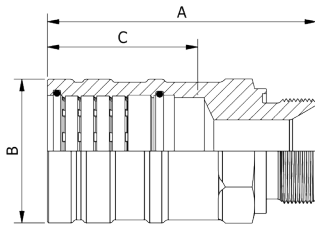

\*MATERIAL CODE:  
 K = STAINLESS STEEL  
 G = CARBON STEEL  
 B = COPPER NICKEL 70/30

ORDER EXAMPLE:  
 DM60153G04

## BSPP Male, OD Tube - DM60153

Size OD	BSPP Size	Part Number	Dimensions - Inch (mm)				*Weight K & G lbs (kg)
			A	B	C Insertion Depth	D	
1/4"	1/4"	DM60153*04	1.63 (41.40)	0.39 (9.91)	0.75 (19.05)	0.75 (19.05)	0.07 (0.03)
3/8"	3/8"	DM60153*06	2.00 (50.80)	0.55 (13.97)	0.92 (23.37)	0.87 (22.10)	0.11 (0.05)
1/2"	1/2"	DM60153*08	2.38 (60.45)	0.75 (19.05)	1.09 (27.69)	1.18 (29.97)	0.24 (0.11)
3/4"	3/4"	DM60153*12	3.25 (82.55)	1.09 (27.69)	1.42 (36.07)	1.42 (36.07)	0.53 (0.24)
1"	1"	DM60153*16	3.50 (88.90)	1.41 (35.81)	1.70 (43.18)	1.81 (45.97)	0.91 (0.41)
1-1/4"	1-1/4"	DM60153*20	3.88 (98.55)	1.73 (43.94)	1.94 (49.28)	1.97 (50.04)	1.41 (0.64)
1-1/2"	1-1/2"	DM80153*3824	4.59 (116.59)	2.05 (52.07)	2.15 (54.61)	2.17 (55.12)	2.14 (0.97)
2"	2"	DM60153*32	4.88 (123.95)	2.58 (65.53)	2.50 (63.50)	2.92 (74.17)	3.16 (1.43)

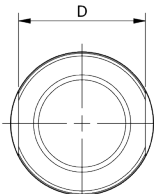
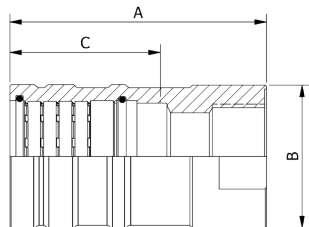

\*MATERIAL CODE:  
 K = STAINLESS STEEL  
 G = CARBON STEEL  
 B = COPPER NICKEL 70/30

ORDER EXAMPLE:  
 DM60086G04

## BSPP Female, OD Tube - DM60086

Size OD	BSPP Size	Part Number	Dimensions - Inch (mm)				*Weight K & G lbs (kg)
			A	B	C Insertion Depth	D	
1/4"	1/4"	DM60086*04	1.69 (42.86)	0.94 (23.03)	0.75 (19.05)	0.79 (20.00)	0.10 (0.05)
3/8"	3/8"	DM60086*06	2.13 (54.10)	1.06 (27.00)	0.92 (23.37)	0.95 (24.00)	0.16 (0.07)
1/2"	1/2"	DM60086*08	2.38 (60.33)	1.25 (31.75)	1.09 (27.69)	1.02 (26.00)	0.25 (0.11)
3/4"	3/4"	DM60086*12	3.13 (79.38)	1.50 (38.10)	1.42 (36.07)	1.26 (32.00)	0.53 (0.24)
1"	1"	DM60086*16	3.50 (88.90)	1.88 (47.63)	1.70 (43.18)	1.65 (42.00)	0.94 (0.43)
1-1/4"	1-1/4"	DM60086*20	3.88 (98.43)	2.25 (57.15)	1.94 (49.28)	2.05 (52.00)	1.49 (0.68)
1-1/2"	1-1/2"	DM80086*3824	4.40 (111.66)	2.75 (69.85)	2.15 (54.61)	2.52 (64.00)	2.60 (1.18)
2"	2"	DM60086*32	4.88 (123.83)	3.50 (88.90)	2.50 (63.50)	2.99 (76.00)	4.22 (1.91)

# DM 60 Series – OD Tube

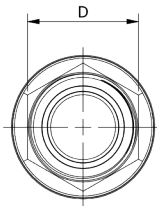
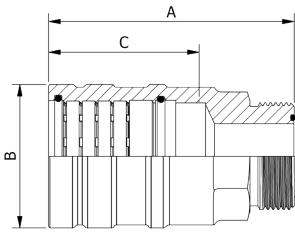

**\*MATERIAL CODE:**  
**K = STAINLESS STEEL**  
**G = CARBON STEEL**  
**B = COPPER NICKEL 70/30**

**ORDER EXAMPLE:**  
**DM60010G04**

## ORFS Male, OD Tube - DM60010

Size OD	ORFS Size	Part Number	Dimensions - Inch (mm)				*Weight K & G lbs (kg)
			A	B	C Insertion Depth	D	
1/4"	04	DM60010*04	1.63 (41.40)	0.39 (9.91)	0.75 (19.05)	0.63 (16.00)	0.07 (0.03)
3/8"	06	DM60010*06	2.00 (50.80)	0.55 (13.97)	0.92 (23.37)	0.75 (19.05)	0.12 (0.05)
1/2"	08	DM60010*08	2.38 (60.45)	0.75 (19.05)	1.09 (27.69)	0.88 (22.35)	0.25 (0.13)
5/8"	10	DM60010*10	2.63 (66.80)	0.93 (23.62)	1.26 (32.00)	1.13 (28.70)	0.34 (0.15)
3/4"	12	DM60010*12	3.25 (82.55)	1.09 (27.69)	1.42 (36.07)	1.25 (31.75)	0.48 (0.22)
1"	16	DM60010*16	3.50 (88.90)	1.41 (35.81)	1.70 (43.18)	1.50 (38.10)	0.82 (0.37)
1-1/4"	20	DM60010*20	3.75 (95.25)	1.73 (43.94)	1.94 (49.28)	1.75 (44.45)	1.20 (0.54)
1-1/2"	24	DM60010*24	4.13 (104.90)	2.05 (52.07)	2.15 (54.61)	2.13 (54.10)	1.80 (0.82)

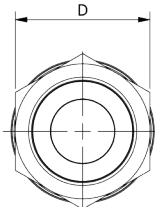
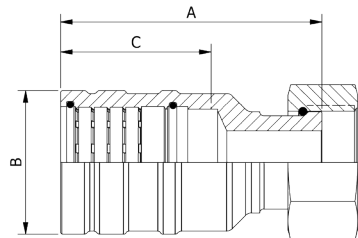

**\*MATERIAL CODE:**  
**K = STAINLESS STEEL**  
**G = CARBON STEEL**  
**B = COPPER NICKEL 70/30**

**ORDER EXAMPLE:**  
**DM60020G04**

## ORFS Female Swivel, OD Tube - DM60020

Size OD	ORFS Size	Part Number	Dimensions - Inch (mm)				*Weight K & G lbs (kg)
			A	B	C Insertion Depth	D	
1/4"	04	DM60020*04	1.75 (44.45)	0.39 (9.91)	0.75 (19.05)	0.67 (17.02)	0.05 (0.02)
3/8"	06	DM60020*06	2.13 (54.10)	0.55 (13.97)	0.92 (23.37)	0.86 (21.84)	0.15 (0.07)
1/2"	08	DM60020*08	2.25 (57.15)	0.75 (19.05)	1.09 (27.69)	0.94 (23.88)	0.20 (0.09)
5/8"	10	DM60020*10	2.50 (63.50)	0.93 (23.62)	1.26 (32.00)	1.17 (29.72)	0.33 (0.15)
3/4"	12	DM60020*12	3.25 (82.55)	1.09 (27.69)	1.42 (36.07)	1.63 (41.40)	0.79 (0.36)
1"	16	DM60020*16	3.50 (88.90)	1.41 (35.81)	1.70 (43.18)	1.75 (44.45)	1.04 (0.47)
1-1/4"	20	DM60020*20	3.63 (92.20)	1.73 (43.94)	1.94 (49.28)	2.13 (54.10)	1.63 (0.74)
1-1/2"	24	DM60020*24	4.00 (101.60)	2.05 (52.07)	2.15 (54.61)	2.38 (60.45)	2.25 (1.02)

3D step models available upon request

# DM 60 Series – OD Tube

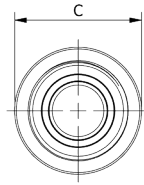
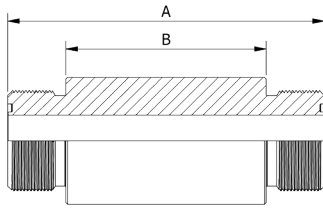

**\*MATERIAL CODE:**  
 K = STAINLESS STEEL  
 G = CARBON STEEL  
 B = COPPER NICKEL 70/30

**ORDER EXAMPLE:**  
 DM60089G08

## Weldable Bulkhead, OD Tube - DM60089

Size OD	ORFS Size	Part Number	Dimensions - Inch (mm)			Thread Details	*Weight K & G lbs (kg)
			A	B	C		
1/2"	08	DM60089*08	3.00 (76.20)	1.99 (50.55)	1.00 (25.40)	13/16"-16UNF-2A	0.49 (0.22)
3/4"	12	DM60089*12	3.75 (95.25)	2.37 (60.20)	1.50 (38.10)	1-3/16"-12UNF-2A	1.31 (0.59)
1"	16	DM60089*16	3.75 (95.25)	2.37 (60.20)	1.75 (44.45)	1-7/16"-12UNF-2A	1.70 (0.77)
1-1/4"	20	DM60089*20	4.00 (101.60)	2.62 (66.55)	2.00 (50.80)	1-11/16"-12UNF-2A	2.28 (1.03)
1-1/2"	24	DM60089*24	4.25 (107.95)	2.87 (72.90)	2.38 (60.45)	2"-12UNF-2A	2.89 (1.31)

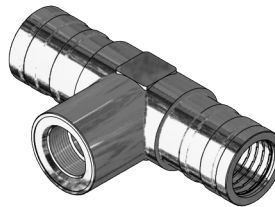
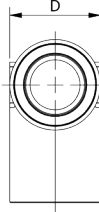
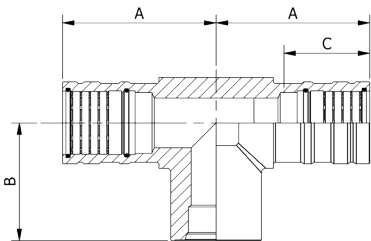

**\*MATERIAL CODE:**  
 K = STAINLESS STEEL  
 G = CARBON STEEL  
 B = COPPER NICKEL 70/30

**ORDER EXAMPLE:**  
 DM60171G0804

Other configurations available.  
 Contact factory for details.

## SAE Female Branch Tee, OD Tube - DM60171

Size OD	SAE Size	Part Number	Dimensions - Inch (mm)				*Weight K & G lbs (kg)
			A	B	C Insertion Depth	D	
1/2"	04	DM60171*0804	1.75 (44.45)	0.75 (19.05)	1.09 (27.69)	0.86 (21.84)	0.31 (0.14)
5/8"	06	DM60171*1006	2.00 (50.80)	1.00 (25.40)	1.26 (32.00)	1.06 (26.92)	0.57 (0.26)
3/4"	08	DM60171*1208	2.68 (68.07)	1.25 (31.75)	1.42 (36.07)	1.30 (33.02)	1.04 (0.47)
1"	10	DM60171*1610	3.03 (76.96)	1.50 (38.10)	1.70 (43.18)	1.58 (40.13)	1.86 (0.84)
1-1/4"	12	DM60171*2012	3.40 (86.36)	1.75 (44.45)	1.94 (49.28)	1.97 (50.04)	3.20 (1.46)
1-1/2"	16	DM60171*2416	4.25 (107.95)	2.00 (50.80)	2.20 (55.88)	2.50 (63.50)	6.23 (2.83)
2"	20	DM60171*3220	4.54 (115.32)	2.25 (57.15)	2.50 (63.50)	2.81 (71.37)	8.06 (3.66)

# DM 60 Series – OD Tube

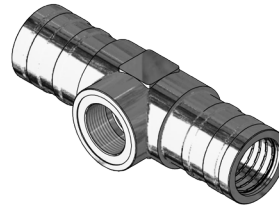
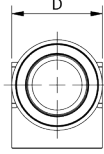
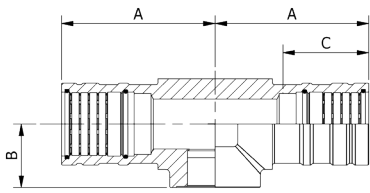

**\*MATERIAL CODE:**  
 K = STAINLESS STEEL  
 G = CARBON STEEL  
 B = COPPER NICKEL 70/30

**ORDER EXAMPLE:**  
 DM60172G0804

Other configurations available.  
 Contact factory for details.

## BSPP Female Branch Tee, OD Tube - DM60172

Size OD	BSPP Size	Part Number	Dimensions - Inch (mm)				*Weight K & G lbs (kg)
			A	B	C Insertion Depth	D	
1/2"	1/4"	DM60172*0804	1.75 (44.45)	0.75 (19.05)	1.09 (27.69)	0.86 (21.84)	0.30 (0.14)
3/4"	1/2"	DM60172*1208	2.68 (68.07)	1.25 (31.75)	1.42 (36.07)	1.30 (33.02)	1.06 (0.48)
1"	3/4"	DM60172*1612	3.03 (76.96)	1.50 (38.10)	1.70 (43.18)	1.58 (40.13)	1.78 (0.81)
1-1/4"	1"	DM60172*2016	3.37 (85.60)	1.75 (44.45)	1.94 (49.28)	1.97 (50.04)	3.09 (1.40)
1-1/2"	1-1/4"	DM80172*3820	4.25 (107.95)	1.63 (41.28)	2.15 (54.61)	2.50 (63.50)	5.53 (2.51)
2"	1-1/2"	DM60172*3224	4.54 (115.32)	2.25 (57.15)	2.50 (63.50)	2.69 (68.33)	7.78 (3.53)

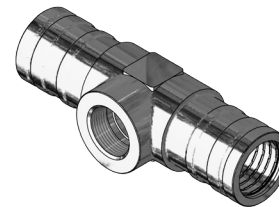
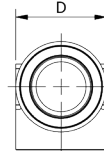
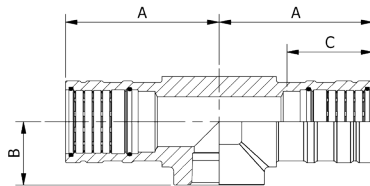

**\*MATERIAL CODE:**  
 K = STAINLESS STEEL  
 G = CARBON STEEL  
 B = COPPER NICKEL 70/30

**ORDER EXAMPLE:**  
 DM60173G0806

Other configurations available.  
 Contact factory for details.

## NPT Female Branch Tee, OD Tube - DM60173

Size OD	NPT Size	Part Number	Dimensions - Inch (mm)				*Weight K & G lbs (kg)
			A	B	C Insertion Depth	D	
1/2"	3/8"	DM60173*0806	1.75 (44.45)	0.75 (19.05)	1.09 (27.69)	0.86 (21.84)	0.29 (0.13)
5/8"	1/2"	DM60173*1008	2.00 (50.80)	1.00 (25.40)	1.26 (32.00)	1.06 (26.92)	0.53 (0.24)
3/4"	1/2"	DM60173*1208	2.68 (68.07)	1.25 (31.75)	1.42 (36.07)	1.30 (33.02)	1.05 (0.48)
1"	3/4"	DM60173*1612	3.03 (76.96)	1.50 (38.10)	1.70 (43.18)	1.58 (40.13)	1.82 (0.83)
1-1/4"	1"	DM60173*2016	3.40 (86.36)	1.75 (44.45)	1.94 (49.28)	1.97 (50.04)	3.19 (1.45)
1-1/2"	1-1/4"	DM60173*2420	4.25 (107.95)	2.00 (50.80)	2.20 (55.88)	2.50 (63.50)	6.12 (2.76)
2"	1-1/2"	DM60173*3224	4.54 (115.32)	2.25 (57.15)	2.50 (63.50)	2.81 (71.37)	7.93 (3.60)













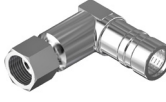









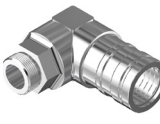





3D step models available upon request



# Specialty Fitting Configuration Guide

## DM 60 Series - OD Tube

1/4" to 2"

					
<b>JIC 37° 90° Elbow Male</b> DM60355	<b>JIC 37° Branch Tee Male</b> DM60177	<b>JIC 37° Run Tee Male</b> DM60178	<b>JIC 37° 90° Elbow Female Swivel</b> DM60354	<b>JIC 37° Branch Tee Female Swivel</b> DM60170	<b>NPT 90° Elbow Male</b> DM60057
					
<b>NPT Branch Tee Male</b> DM60176	<b>NPT Run Tee Male</b> DM60181	<b>NPT 90° Elbow Female</b> DM60061	<b>ORFS 90° Elbow Male</b> DM60011	<b>ORFS Branch Tee Male</b> DM60013	<b>ORFS Run Tee Male</b> DM60014
					
<b>ORFS 90° Elbow Female Swivel</b> DM60021	<b>ORFS Branch Tee Female Swivel</b> DM60023	<b>SAE 90° Elbow Male</b> DM60105	<b>SAE Branch Tee Male</b> DM60174	<b>SAE Run Tee Male</b> DM60179	<b>SAE 90° Elbow Female</b> DM60387
					
<b>BSPP 90° Elbow Male</b> DM60168	<b>BSPP Branch Tee Male</b> DM60175	<b>BSPP Run Tee Male</b> DM60180	<b>BSPP 90° Elbow Female</b> DM60169	<b>BSPP Cross Fitting with 2 Ports</b> DM60221	<b>BSPP Cross Fitting with 4 Ports</b> DM60241
					
<b>Flange - ANSI #900</b> DM60025	<b>Flange - ANSI #1500</b> DM60026	<b>Compact Elbow x Code 61 Flange</b> DM60231	<b>Compact Elbow x Code 62 Flange</b> DM60232	<b>90° PYPLOK® x SAE Code 61 Flange</b> DM60391	<b>90° PYPLOK® x SAE Code 62 Flange</b> DM60392

# Specialty Fitting Configuration Guide

## DM 60 Series - OD Tube

1/4" to 2"



**NPS to OD Tube Reducer**  
DM20501



**CPV Female**  
DM60040



**CPV Male Union**  
DM60041



**Extra Long Coupling**  
DM60301



**Tailpiece Gaugeline Adapter**  
DM60050

Introduction

Technical Information

DM 20 – NPS Pipe

DM 60 – OD Tube

DM 80 – Metric Tube

DM Series Thread Adapter

DM 80 – Metric & JIS Tube

DP 40N – NPS Low Pressure

DP 40M – Metric Low Pressure

PYPLOK® Tooling

Installation Procedures

Appendix



# General Characteristics

## DM 80 Series - Metric Tube

### Fitting Material Specifications

K = Stainless Steel  
 \*G = Carbon Steel  
 B = Copper Nickel 70/30  
 C = Copper Nickel 90/10  
 D = Duplex  
 Z = Super Duplex

### Material Specification

ASTM-A479/A182-316  
 ASTM-A105/A350 LF2  
 MIL-C71500  
 MIL-C70600  
 ASTM-A479/A182-UNS31803  
 ASTM-A479/A182-UNS32750

\*60mm Carbon Steel PYPLOK® material specification is AISI/SAE-4140 unless otherwise noted.

### O-Ring Material Specifications

VITON (Brown Colour)  
 EPDM (Black Colour)

### O-Ring Temperature Limits

-15°F to 400°F (-26°C to 205°C)  
 -60°F to 400°F (-51°C to 205°C)

For seal compatibility and selection for each system consult factory. Other seal materials for specific applications of compatibility and temperature are available upon request.

### Ordering Information

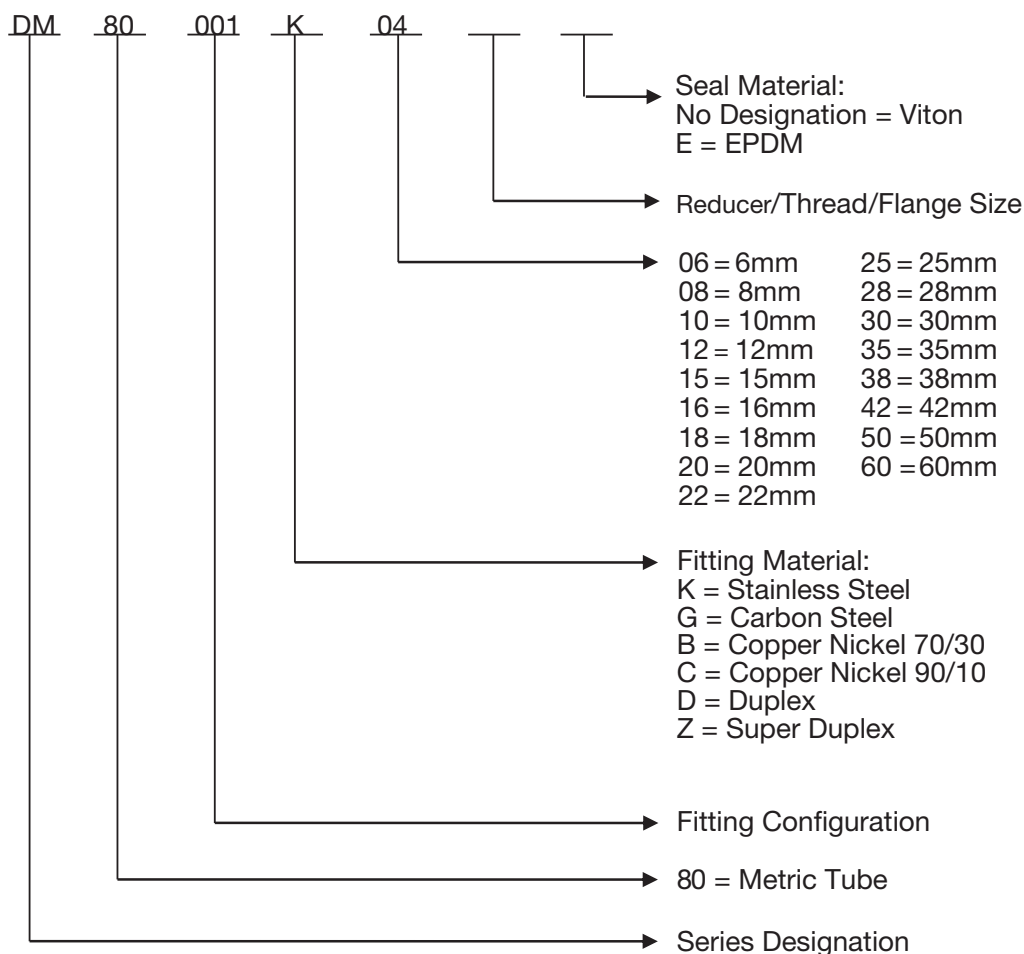

System design and safe application is the responsibility of the end-user. Consideration must be taken to confirm proper fitting selection is made to ensure proper compatibility, function and operation of the fitting within the piping system. The technical and performance information such as weights, dimensions and ratings in this catalogue supersede all previous published data. Tube-Mac® reserves the right to change technical data and product dimension, ratings and other aspects without notice.

# Standard Fitting Configuration Guide

## DM 80 Series - Metric Tube

6mm to 60mm

					
<b>Coupling</b> DM80001 Page E3	<b>Coupling with Inner Stop</b> DM80002 Page E4	<b>90° Elbow</b> DM80003 Page E5	<b>45° Elbow</b> DM80017 Page E6	<b>Tee</b> DM80004 Page E7	<b>Reducing Tee</b> DM80104 Page E8
					
<b>Reducer</b> DM80101 Page E9	<b>End Cap</b> DM80085 Page E10	<b>Flange - PN16</b> DM80028 Page E11	<b>Flange - PN40</b> DM80029 Page E11	<b>SAE Flange Body</b> DM80090 Page E12	<b>ISO 6162-1 Flange</b> DM80091 Page E13
					
<b>ISO 6162-2 Flange</b> DM80092 Page E13	<b>ISO 6162-1 Tapped Flange</b> DM80095 Page E14	<b>ISO 6162-2 Tapped Flange</b> DM80096 Page E14	<b>JIC 37° Male</b> DM80055 Page E15	<b>JIC 37° Female Swivel</b> DM80054 Page E15	<b>BSPP Male</b> DM80153 Page E16
					
<b>BSPP Female</b> DM80086 Page E17	<b>DIN 24° Male</b> DM80066 Page E18	<b>DIN 24° Female Swivel</b> DM80068 Page E19	<b>Weldable Bulkhead</b> DM80089 Page E20	<b>BSPP Female Branch Tee</b> DM80172 Page E21	<b>Tee with BSPP Branch</b> DM80211 Page E22
					
<b>BSPP Cross Fitting with 2 Ports</b> DM80221 Page E23	<b>BSPP Cross Fitting with 4 Ports</b> DM80241 Page E24				

# DM 80 Series - Metric Tube

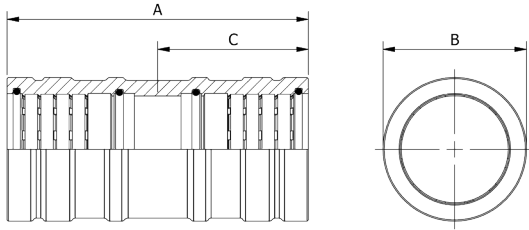

**\*MATERIAL CODE:**  
**K = STAINLESS STEEL**  
**G = CARBON STEEL**  
**B = COPPER NICKEL 70/30**

**ORDER EXAMPLE:**  
**DM80001G06**

Coupling, Metric - DM80001					
Size OD (mm)	Part Number	Dimensions - mm (Inch)			*Weight K & G kg (lbs)
		A	B	C Insertion Depth	
6	DM80001*06	33.00 (1.30)	9.80 (0.39)	16.51 (0.65)	0.01 (0.02)
8	DM80001*08	38.61 (1.52)	12.19 (0.48)	19.30 (0.76)	0.02 (0.03)
10	DM80001*10	48.30 (1.90)	15.09 (0.59)	24.13 (0.95)	0.03 (0.06)
12	DM80001*12	54.00 (2.13)	18.59 (0.73)	27.00 (1.06)	0.05 (0.10)
15	DM80001*15	64.01 (2.52)	23.70 (0.93)	32.00 (1.26)	0.10 (0.23)
16	DM80001*16	64.01 (2.52)	23.70 (0.93)	32.00 (1.26)	0.09 (0.19)
18	DM80001*18	69.85 (2.75)	25.15 (0.99)	35.05 (1.38)	0.09 (0.20)
20	DM80001*20	74.17 (2.91)	28.70 (1.13)	37.08 (1.46)	0.15 (0.32)
22	DM80001*22	76.20 (3.00)	30.48 (1.20)	38.10 (1.50)	0.15 (0.33)
25	DM80001*25	84.07 (3.31)	35.31 (1.39)	41.91 (1.65)	0.24 (0.53)
28	DM80001*28	88.90 (3.50)	37.59 (1.48)	44.45 (1.75)	0.24 (0.54)
30	DM80001*30	93.98 (3.70)	41.91 (1.65)	46.99 (1.85)	0.39 (0.85)
35	DM80001*35	101.60 (4.00)	46.23 (1.82)	50.80 (2.00)	0.41 (0.91)
38	DM80001*38	108.97 (4.29)	52.07 (2.05)	54.61 (2.15)	0.71 (1.57)
42	DM20001*20	120.65 (4.75)	57.40 (2.26)	60.45 (2.38)	0.89 (1.96)
50	DM80001*50	127.00 (5.00)	65.53 (2.58)	63.50 (2.50)	1.12 (2.46)
**60K	DM20001K32	177.80 (7.00)	77.22 (3.04)	88.90 (3.50)	2.00 (4.40)
60G	DM80001G60	177.80 (7.00)	77.22 (3.04)	88.90 (3.50)	2.00 (4.40)

\*\*2" DM 20 Series Stainless Steel fittings are also used for 60mm Stainless Steel applications.

# DM 80 Series - Metric Tube

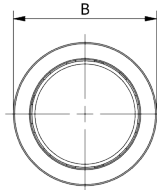
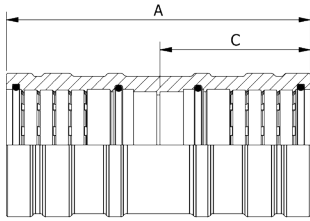

**\*MATERIAL CODE:**  
**K = STAINLESS STEEL**  
**G = CARBON STEEL**  
**B = COPPER NICKEL 70/30**

**ORDER EXAMPLE:**  
**DM80002G06**

## Coupling with Inner Stop, Metric - DM80002

Size OD (mm)	Part Number	Dimensions - mm (Inch)			*Weight K & G kg (lbs)
		A	B	C Insertion Depth	
6	DM80002*06	34.29 (1.35)	9.80 (0.39)	16.51 (0.65)	0.01 (0.02)
8	DM80002*08	39.88 (1.57)	12.19 (0.48)	19.30 (0.76)	0.01 (0.03)
10	DM80002*10	49.53 (1.95)	15.09 (0.59)	24.13 (0.95)	0.06 (0.03)
12	DM80002*12	55.37 (2.18)	18.59 (0.73)	26.92 (1.06)	0.05 (0.10)
15	DM80002*15	65.28 (2.57)	23.70 (0.93)	32.00 (1.26)	0.10 (0.23)
16	DM80002*16	65.28 (2.57)	23.70 (0.93)	32.00 (1.26)	0.09 (0.20)
18	DM80002*18	71.12 (2.80)	25.15 (0.99)	35.05 (1.38)	0.10 (0.22)
20	DM80002*20	75.44 (2.97)	28.70 (1.13)	37.08 (1.46)	0.15 (0.32)
22	DM80002*22	77.47 (3.05)	30.48 (1.20)	38.10 (1.50)	0.15 (0.33)
25	DM80002*25	85.34 (3.36)	35.31 (1.39)	41.91 (1.65)	0.24 (0.54)
28	DM80002*28	90.17 (3.55)	37.59 (1.48)	44.45 (1.75)	0.25 (0.55)
30	DM80002*30	95.25 (3.75)	41.91 (1.65)	46.99 (1.85)	0.39 (0.85)
35	DM80002*35	102.87 (4.05)	46.23 (1.82)	50.80 (2.00)	0.41 (0.91)
38	DM80002*38	110.24 (4.34)	52.07 (2.05)	54.61 (2.15)	0.71 (1.57)
42	DM20002*20	121.92 (4.80)	57.40 (2.26)	60.45 (2.38)	0.89 (1.96)
50	DM80002*50	128.27 (5.05)	65.53 (2.58)	63.50 (2.50)	0.89 (1.96)
**60K	DM20002K32	179.07 (7.05)	77.22 (3.04)	88.90 (3.50)	2.00 (4.40)
60G	DM80002G60	179.07 (7.05)	77.22 (3.04)	88.90 (3.50)	2.00 (4.40)

\*\*2" DM 20 Series Stainless Steel fittings are also used for 60mm Stainless Steel applications.

# DM 80 Series - Metric Tube

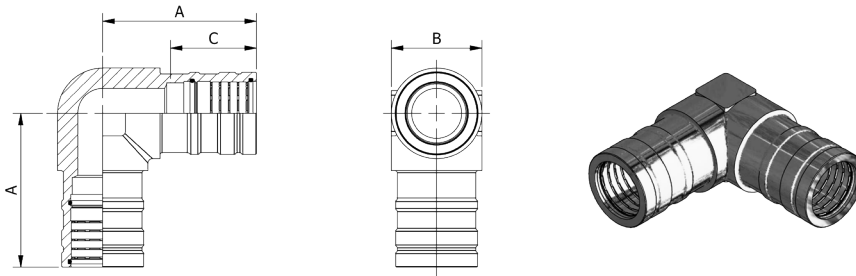

**\*MATERIAL CODE:**  
**K = STAINLESS STEEL**  
**G = CARBON STEEL**  
**B = COPPER NICKEL 70/30**

**ORDER EXAMPLE:**  
**DM80003G06**

## 90° Elbow, Metric - DM80003

Size OD (mm)	Part Number	Dimensions - mm (Inch)			*Weight K & G kg (lbs)
		A	B	C Insertion Depth	
6	DM80003*06	27.94 (1.10)	11.81 (0.47)	16.51 (0.65)	0.02 (0.04)
8	DM80003*08	35.31 (1.39)	16.00 (0.63)	19.30 (0.76)	0.04 (0.08)
10	DM80003*10	42.67 (1.68)	21.84 (0.86)	24.13 (0.95)	0.08 (0.18)
12	DM80003*12	45.29 (1.78)	21.84 (0.86)	26.92 (1.06)	0.09 (0.20)
15	DM80003*15	52.07 (2.05)	26.92 (1.06)	32.00 (1.26)	0.18 (0.40)
16	DM80003*16	52.07 (2.05)	26.92 (1.06)	32.00 (1.26)	0.20 (0.43)
18	DM80003*18	52.07 (2.05)	26.92 (1.06)	35.05 (1.38)	0.21 (0.46)
20	DM80003*20	73.15 (2.88)	33.02 (1.30)	37.08 (1.46)	0.36 (0.80)
22	DM80003*22	73.15 (2.88)	33.02 (1.30)	38.10 (1.50)	0.47 (1.04)
25	DM80003*25	76.96 (3.03)	40.13 (1.58)	41.91 (1.65)	0.58 (1.27)
28	DM80003*28	76.96 (3.03)	40.13 (1.58)	44.45 (1.75)	0.66 (1.45)
30	DM80003*30	85.60 (3.37)	50.04 (1.97)	46.99 (1.85)	1.13 (2.50)
35	DM80003*35	85.60 (3.37)	50.04 (1.97)	50.80 (2.00)	1.18 (2.60)
38	DM80003*38	107.95 (4.25)	63.50 (2.50)	54.61 (2.15)	2.46 (5.42)
42	DM20003*20	107.95 (4.25)	63.50 (2.50)	60.45 (2.38)	2.70 (5.95)
50	DM80003*50	115.32 (4.54)	71.37 (2.81)	63.50 (2.50)	3.18 (7.00)
**60K	DM20003K32	138.43 (5.45)	82.55 (3.25)	88.90 (3.50)	4.40 (9.70)
60G	DM80003G60	138.43 (5.45)	82.55 (3.25)	88.90 (3.50)	4.40 (9.70)

\*\*2" DM 20 Series Stainless Steel fittings are also used for 60mm Stainless Steel applications.



# DM 80 Series - Metric Tube

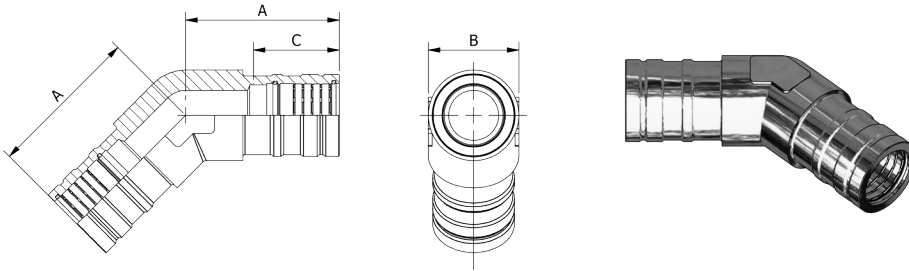

**\*MATERIAL CODE:**  
**K = STAINLESS STEEL**  
**G = CARBON STEEL**  
**B = COPPER NICKEL 70/30**

**ORDER EXAMPLE:**  
**DM80017G06**

## 45° Elbow, Metric - DM80017

Size OD (mm)	Part Number	Dimensions - mm (Inch)			*Weight K & G kg (lbs)
		A	B	C Insertion Depth	
6	DM80017*06	27.94 (1.10)	11.81 (0.47)	16.51 (0.65)	0.02 (0.05)
8	DM80017*08	35.31 (1.39)	16.00 (0.63)	19.30 (0.76)	0.05 (0.10)
10	DM80017*10	42.67 (1.68)	21.84 (0.86)	24.13 (0.95)	0.09 (0.19)
12	DM80017*12	45.21 (1.78)	21.84 (0.86)	26.92 (1.06)	0.13 (0.29)
15	DM80017*15	52.07 (2.05)	26.92 (1.06)	32.00 (1.26)	0.23 (0.50)
16	DM80017*16	52.07 (2.05)	26.92 (1.06)	32.00 (1.26)	0.23 (0.50)
18	DM80017*18	52.07 (2.05)	26.92 (1.06)	35.05 (1.38)	0.21 (0.47)
20	DM80017*20	73.15 (2.88)	33.02 (1.30)	37.08 (1.46)	0.46 (1.02)
22	DM80017*22	73.15 (2.88)	33.02 (1.30)	38.10 (1.50)	0.48 (1.05)
25	DM80017*25	76.96 (3.03)	40.13 (1.58)	41.91 (1.65)	0.72 (1.59)
28	DM80017*28	76.96 (3.03)	40.13 (1.58)	44.45 (1.75)	0.68 (1.50)
30	DM80017*30	85.60 (3.37)	50.04 (1.97)	46.99 (1.85)	1.22 (2.68)
35	DM80017*35	85.60 (3.37)	50.04 (1.97)	50.80 (2.00)	1.16 (2.55)
38	DM80017*38	107.95 (4.25)	63.50 (2.50)	54.61 (2.15)	2.30 (5.08)
42	DM20017*20	107.95 (4.25)	63.50 (2.50)	60.45 (2.38)	2.54 (5.60)
50	DM80017*50	115.32 (4.54)	71.37 (2.81)	63.50 (2.50)	3.30 (7.27)
**60	DM20017K32	138.43 (5.45)	82.55 (3.25)	88.90 (3.50)	4.35 (9.60)

\*\*Only available in Stainless Steel.

# DM 80 Series - Metric Tube

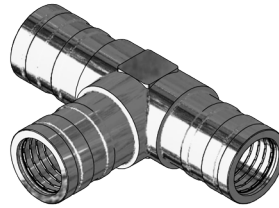
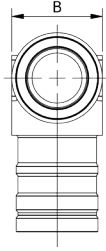
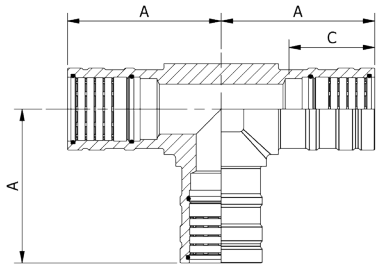

**\*MATERIAL CODE:**  
**K = STAINLESS STEEL**  
**G = CARBON STEEL**  
**B = COPPER NICKEL 70/30**

**ORDER EXAMPLE:**  
**DM80004G06**

## Tee, Metric - DM80004

Size OD (mm)	Part Number	Dimensions - mm (Inch)			*Weight K & G kg (lbs)
		A	B	C Insertion Depth	
6	DM80004*06	27.94 (1.10)	11.81 (0.47)	16.51 (0.65)	0.03 (0.06)
8	DM80004*08	35.31 (1.39)	16.00 (0.63)	19.30 (0.76)	0.06 (0.13)
10	DM80004*10	42.67 (1.68)	21.84 (0.86)	24.13 (0.95)	0.09 (0.20)
12	DM80004*12	45.21 (1.78)	21.84 (0.86)	26.92 (1.06)	0.15 (0.34)
15	DM80004*15	52.07 (2.05)	26.92 (1.06)	32.00 (1.26)	0.27 (0.59)
16	DM80004*16	52.07 (2.05)	26.92 (1.06)	32.00 (1.26)	0.29 (0.65)
18	DM80004*18	52.07 (2.05)	26.92 (1.06)	35.05 (1.38)	0.27 (0.60)
20	DM80004*20	73.15 (2.88)	33.02 (1.30)	37.08 (1.46)	0.59 (1.30)
22	DM80004*22	73.15 (2.88)	33.02 (1.30)	38.10 (1.50)	0.64 (1.42)
25	DM80004*25	76.96 (3.03)	40.13 (1.58)	41.91 (1.65)	0.91 (2.01)
28	DM80004*28	76.96 (3.03)	40.13 (1.58)	44.45 (1.75)	0.89 (1.96)
30	DM80004*30	85.60 (3.37)	50.04 (1.97)	46.99 (1.85)	1.46 (3.22)
35	DM80004*35	85.60 (3.37)	50.04 (1.97)	50.80 (2.00)	1.46 (3.22)
38	DM80004*38	107.95 (4.25)	63.50 (2.50)	54.61 (2.15)	3.00 (6.61)
42	DM20004*20	107.95 (4.25)	63.50 (2.50)	60.45 (2.38)	3.22 (7.10)
50	DM80004*50	115.32 (4.54)	71.37 (2.81)	63.50 (2.50)	4.09 (9.02)
**60K	DM20004K32	138.43 (5.45)	71.37 (2.81)	88.90 (3.50)	5.55 (12.20)
60G	DM80004G60	138.43 (5.45)	82.55 (3.25)	88.90 (3.50)	5.55 (12.20)

\*\*2" DM 20 Series Stainless Steel fittings are also used for 60mm Stainless Steel applications.

# DM 80 Series - Metric Tube

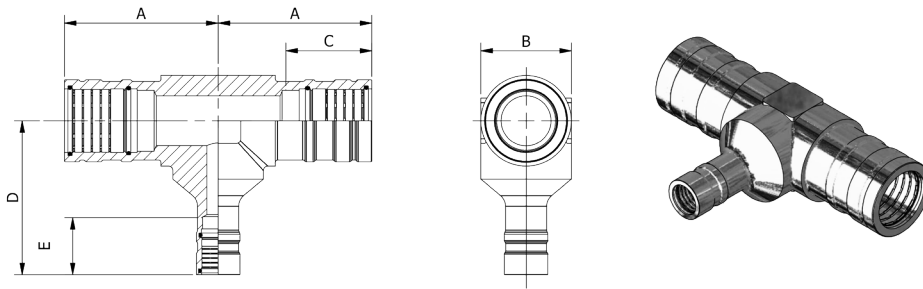

\*MATERIAL CODE:

K = STAINLESS STEEL

G = CARBON STEEL

B = COPPER NICKEL 70/30

ORDER EXAMPLE:

DM80104G0806

Other configurations available.

Contact factory for details.

## Reducing Tee, Metric - DM80104

Run Size OD (mm)	Branch Size OD (mm)	Part Number	Dimensions - mm (Inch)					*Weight K & G kg (lbs)
			A	B	C Insertion Depth	D	E Insertion Depth	
8	6	DM80104*0806	35.31 (1.39)	16.00 (0.63)	19.30 (0.76)	31.75 (1.25)	16.51 (0.65)	0.06 (0.13)
10	8	DM80104*1008	42.67 (1.68)	21.84 (0.86)	24.13 (0.95)	41.91 (1.65)	19.30 (0.76)	0.11 (0.24)
12	10	DM80104*1210	42.21 (1.78)	21.84 (0.86)	26.92 (1.06)	46.23 (0.82)	24.13 (0.95)	0.17 (0.37)
15	10	DM80104*1510	52.07 (2.05)	26.92 (1.06)	32.00 (1.26)	47.50 (1.87)	24.13 (0.95)	0.28 (0.61)
15	12	DM80104*1512	52.07 (2.05)	26.92 (1.06)	32.00 (1.26)	49.53 (1.95)	26.92 (1.06)	0.29 (0.63)
16	10	DM80104*1610	52.07 (2.05)	26.92 (1.06)	32.00 (1.26)	47.50 (1.87)	24.13 (0.95)	0.27 (0.59)
16	12	DM80104*1612	52.07 (2.05)	26.92 (1.06)	32.00 (1.26)	49.28 (1.94)	26.92 (1.06)	0.26 (0.57)
18	12	DM80104*1812	52.07 (2.05)	26.92 (1.06)	35.05 (1.38)	46.48 (1.83)	26.92 (1.06)	0.25 (0.56)
18	15	DM80104*1815	52.07 (2.05)	26.92 (1.06)	35.05 (1.38)	50.80 (2.00)	32.00 (1.26)	0.29 (0.63)
20	12	DM80104*2012	73.15 (2.88)	33.02 (1.30)	37.08 (1.46)	52.83 (2.08)	26.92 (1.06)	0.54 (1.19)
20	16	DM80104*2016	73.15 (2.88)	33.02 (1.30)	37.08 (1.46)	65.28 (2.57)	32.00 (1.26)	0.56 (1.24)
22	15	DM80104*2215	73.15 (2.88)	33.02 (1.30)	38.10 (1.50)	57.40 (2.26)	32.00 (1.26)	0.54 (1.19)
22	18	DM80104*2218	73.15 (2.88)	33.02 (1.30)	38.10 (1.50)	63.50 (2.50)	38.10 (1.50)	0.54 (1.20)
25	16	DM80104*2516	76.96 (3.03)	40.13 (1.58)	41.91 (1.65)	72.14 (2.84)	32.00 (1.26)	0.91 (2.00)
25	20	DM80104*2520	76.96 (3.03)	40.13 (1.58)	41.91 (1.65)	79.76 (3.14)	37.08 (1.46)	1.09 (2.40)
28	18	DM80104*2818	76.96 (3.03)	40.13 (1.58)	44.45 (1.75)	76.20 (3.00)	35.05 (1.38)	0.86 (1.90)
28	22	DM80104*2822	76.96 (3.03)	40.13 (1.58)	44.45 (1.75)	79.76 (3.14)	38.10 (1.50)	0.87 (1.91)
30	20	DM80104*3020	85.60 (3.37)	50.04 (1.97)	46.99 (1.85)	79.76 (3.14)	37.08 (1.46)	1.44 (3.18)
30	25	DM80104*3025	85.60 (3.37)	50.04 (1.97)	46.99 (1.85)	85.60 (3.37)	41.91 (1.65)	1.51 (3.22)
35	20	DM80104*3520	85.60 (3.37)	50.04 (1.97)	50.80 (2.00)	85.60 (3.37)	37.08 (1.46)	1.41 (3.10)
35	22	DM80104*3522	85.60 (3.37)	50.04 (1.97)	50.80 (2.00)	85.60 (3.37)	38.10 (1.50)	1.49 (3.28)
35	28	DM80104*3528	85.60 (3.37)	50.04 (1.97)	50.80 (2.00)	85.60 (3.37)	44.45 (1.75)	1.56 (3.43)
38	25	DM80104*3825	107.95 (4.25)	63.50 (2.50)	54.61 (2.15)	107.95 (4.25)	41.91 (1.65)	3.06 (6.75)
38	30	DM80104*3830	107.95 (4.25)	63.50 (2.50)	54.61 (2.15)	107.95 (4.25)	46.99 (1.85)	3.04 (6.70)
42	35	DM80104*4235	107.95 (4.25)	63.50 (2.50)	60.45 (2.38)	107.95 (4.25)	50.80 (2.00)	3.19 (7.04)
42	38	DM80104*4238	107.95 (4.25)	63.50 (2.50)	60.45 (2.38)	107.95 (4.25)	54.61 (2.15)	3.67 (8.08)
50	38	DM80104*5038	115.32 (4.54)	71.37 (2.81)	63.50 (2.50)	115.32 (4.54)	54.61 (2.15)	4.11 (9.06)
50	42	DM80104*5042	115.32 (4.54)	71.37 (2.81)	63.50 (2.50)	115.32 (4.54)	60.45 (2.38)	3.98 (8.78)
60	38	DM80104*6038	138.43 (5.45)	82.55 (3.25)	88.90 (3.50)	138.43 (5.45)	54.61 (2.15)	6.21 (13.69)
60	50	DM80104*6050	138.43 (5.45)	82.55 (3.25)	88.90 (3.50)	138.43 (5.45)	63.50 (2.50)	6.23 (13.73)

# DM 80 Series - Metric Tube

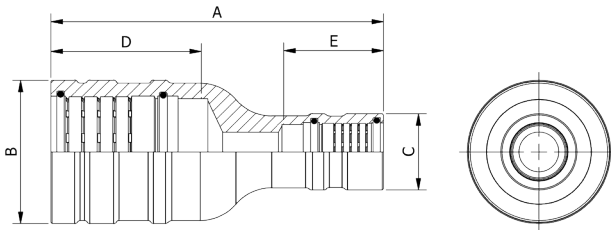

**\*MATERIAL CODE:**  
**K = STAINLESS STEEL**  
**G = CARBON STEEL**  
**B = COPPER NICKEL 70/30**

**ORDER EXAMPLE:**  
**DM80101G0806**

**Other configurations available.**  
**Contact factory for details.**

## Reducer, Metric - DM80101

End 1 Size OD (mm)	End 2 Size OD (mm)	Part Number	Dimensions - mm (Inch)					*Weight K & G kg (lbs)
			A	B	C	D Insertion Depth	E Insertion Depth	
8	6	DM80101*0806	50.80 (2.00)	12.19 (0.48)	9.40 (0.37)	19.30 (0.76)	16.51 (0.65)	0.02 (0.04)
10	8	DM80101*1008	57.15 (2.25)	15.09 (0.59)	12.19 (0.48)	24.13 (0.95)	19.30 (0.76)	0.09 (0.20)
12	10	DM80101*1210	63.50 (2.50)	18.59 (0.73)	14.99 (0.59)	26.92 (1.06)	24.13 (0.95)	0.05 (0.11)
15	10	DM80101*1510	73.15 (2.88)	23.70 (0.93)	14.99 (0.59)	32.00 (1.26)	24.13 (0.95)	0.09 (0.19)
15	12	DM80101*1512	73.15 (2.88)	23.70 (0.93)	18.54 (0.73)	32.00 (1.26)	26.92 (1.06)	0.10 (0.21)
16	10	DM80101*1610	73.15 (2.88)	23.70 (0.93)	14.99 (0.59)	32.00 (1.26)	24.13 (0.95)	0.07 (0.17)
16	12	DM80101*1612	76.20 (3.00)	23.70 (0.93)	18.54 (0.73)	32.00 (1.26)	26.92 (1.06)	0.10 (0.22)
18	12	DM80101*1812	76.20 (3.00)	25.15 (0.99)	18.54 (0.73)	35.05 (1.38)	26.92 (1.06)	0.09 (0.20)
18	15	DM80101*1815	76.20 (3.00)	25.15 (0.99)	23.62 (0.93)	35.05 (1.38)	32.00 (1.26)	0.14 (0.30)
20	12	DM80101*2012	82.55 (3.25)	28.70 (1.13)	18.54 (0.73)	37.08 (1.46)	26.92 (1.06)	0.14 (0.30)
20	16	DM80101*2016	88.90 (3.50)	28.70 (1.13)	23.62 (0.93)	37.08 (1.46)	32.00 (1.26)	0.16 (0.36)
22	15	DM80101*2215	85.85 (3.38)	30.48 (1.20)	23.62 (0.93)	38.10 (1.50)	32.00 (1.26)	0.16 (0.36)
22	18	DM80101*2218	85.85 (3.38)	30.48 (1.20)	25.15 (0.99)	38.10 (1.50)	35.05 (1.38)	0.15 (0.33)
25	16	DM80101*2516	95.25 (3.75)	35.31 (1.39)	23.62 (0.93)	41.91 (1.65)	32.00 (1.26)	0.23 (0.50)
25	20	DM80101*2520	99.06 (3.90)	35.31 (1.39)	28.70 (1.13)	41.91 (1.65)	37.08 (1.46)	0.25 (0.55)
28	18	DM80101*2818	95.55 (3.88)	37.59 (1.48)	25.15 (0.99)	44.45 (1.75)	35.05 (1.38)	0.25 (0.55)
28	22	DM80101*2822	107.95 (4.25)	37.59 (1.48)	30.48 (1.20)	44.45 (1.75)	38.10 (1.50)	0.29 (0.65)
30	20	DM80101*3020	107.95 (4.25)	41.91 (1.65)	28.70 (1.13)	46.99 (1.85)	37.08 (1.46)	0.31 (0.68)
30	25	DM80101*3025	114.30 (4.50)	41.91 (1.65)	35.31 (1.39)	46.99 (1.85)	41.91 (1.65)	0.38 (0.84)
35	22	DM80101*3522	114.30 (4.50)	46.23 (1.82)	30.48 (1.20)	50.80 (2.00)	38.10 (1.50)	0.45 (1.00)
35	28	DM80101*3528	120.65 (4.75)	46.23 (1.82)	37.59 (1.48)	50.80 (2.00)	44.45 (1.75)	0.48 (1.06)
38	25	DM80101*3825	120.65 (4.75)	52.07 (2.05)	35.31 (1.39)	54.61 (2.15)	41.91 (1.65)	0.64 (1.40)
38	30	DM80101*3830	130.02 (5.13)	52.07 (2.05)	41.91 (1.65)	54.61 (2.15)	46.99 (1.85)	0.75 (1.65)
42	35	DM80101*4235	133.35 (5.25)	57.50 (2.26)	46.23 (1.82)	60.45 (2.38)	50.80 (2.00)	0.83 (1.83)
42	38	DM80101*4238	143.00 (5.63)	57.50 (2.26)	52.07 (2.05)	60.45 (2.38)	54.61 (2.15)	1.00 (2.20)
50	38	DM80101*5038	152.40 (6.00)	65.53 (2.58)	52.07 (2.05)	63.50 (2.50)	54.61 (2.15)	1.22 (2.69)
50	42	DM80101*5042	158.75 (6.25)	65.53 (2.58)	57.40 (2.26)	63.50 (2.50)	60.45 (2.38)	1.31 (2.88)
60	38	DM80101*6038	165.10 (6.50)	77.22 (3.04)	52.07 (2.05)	88.90 (3.50)	54.61 (2.15)	1.81 (3.99)
60	50	DM80101*6050	174.75 (6.88)	77.22 (3.04)	65.53 (2.58)	88.90 (3.50)	63.50 (2.50)	1.90 (4.19)

3D step models available upon request

# DM 80 Series - Metric Tube

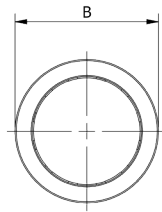
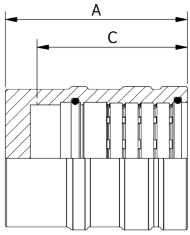

**\*MATERIAL CODE:**  
**K = STAINLESS STEEL**  
**G = CARBON STEEL**  
**B = COPPER NICKEL 70/30**

**ORDER EXAMPLE:**  
**DM80085G06**

## End Cap, Metric - DM80085

Size OD (mm)	Part Number	Dimensions - mm (Inch)			*Weight K & G kg (lbs)
		A	B	C Insertion Depth	
6	DM80085*06	23.11 (0.91)	9.80 (0.39)	16.51 (0.65)	0.01 (0.02)
8	DM80085*08	29.21 (1.15)	12.19 (0.48)	19.30 (0.76)	0.01 (0.02)
10	DM80085*10	33.78 (1.33)	15.09 (0.59)	24.13 (0.95)	0.02 (0.05)
12	DM80085*12	37.59 (1.48)	18.59 (0.73)	26.92 (1.06)	0.04 (0.08)
15	DM80085*15	45.72 (1.80)	23.70 (0.93)	32.00 (1.26)	0.09 (0.19)
16	DM80085*16	45.72 (1.80)	23.70 (0.93)	32.00 (1.26)	0.08 (0.17)
18	DM80085*18	51.82 (2.04)	25.15 (0.99)	35.05 (1.38)	0.10 (0.21)
20	DM80085*20	55.63 (2.19)	28.70 (1.13)	37.08 (1.46)	0.14 (0.31)
22	DM80085*22	56.64 (2.23)	30.48 (1.20)	38.10 (1.50)	0.15 (0.33)
25	DM80085*25	60.71 (2.39)	35.31 (1.39)	41.91 (1.65)	0.23 (0.50)
28	DM80085*28	62.99 (2.48)	37.59 (1.48)	44.45 (1.75)	0.24 (0.52)
30	DM80085*30	65.53 (2.58)	41.91 (1.65)	46.99 (1.85)	0.34 (0.76)
35	DM80085*35	69.34 (2.73)	46.23 (1.82)	50.80 (2.00)	0.39 (0.85)
38	DM80085*38	73.15 (2.88)	52.07 (2.05)	54.61 (2.15)	0.62 (1.36)
42	DM20085*20	73.15 (2.88)	57.40 (2.26)	60.45 (2.38)	0.65 (1.44)
50	DM80085*50	82.04 (3.23)	65.53 (2.58)	63.50 (2.50)	0.92 (2.03)
**60K	DM20085K32	104.90 (4.13)	77.22 (3.04)	88.90 (3.50)	1.42 (3.13)
60G	DM80085G60	104.90 (4.13)	77.22 (3.04)	88.90 (3.50)	1.42 (3.13)

\*\*2" DM 20 Series Stainless Steel fittings are also used for 60mm Stainless Steel applications.

# DM 80 Series - Metric Tube

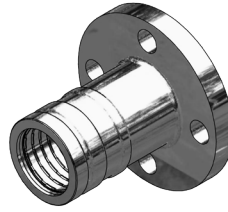
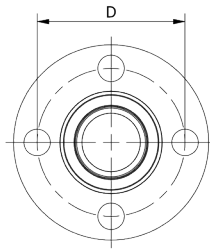
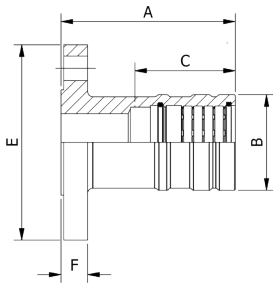

**\*MATERIAL CODE:**  
 K = STAINLESS STEEL  
 G = CARBON STEEL  
 B = COPPER NICKEL 70/30

**ORDER EXAMPLE:**  
 DM80028G2015

## Flange – PN16, Metric - DM80028

Size OD (mm)	Flange Size	Part Number	Dimensions - mm (Inch)						Bolt Size	*Weight K & G kg (lbs)
			A	B	C Insertion Depth	D	E	F		
20	DN15	DM80028*2015	80.01 (3.15)	28.70 (1.13)	37.08 (1.46)	65.02 (2.56)	95.00 (3.74)	14.00 (0.55)	M12	0.79 (1.75)
25	DN20	DM80028*2520	85.09 (3.35)	35.31 (1.39)	41.91 (1.65)	74.93 (2.95)	104.90 (4.13)	16.00 (0.63)	M12	1.15 (2.54)
30	DN25	DM80028*3025	95.00 (3.74)	41.91 (1.65)	46.99 (1.85)	85.09 (3.35)	115.06 (4.53)	16.00 (0.63)	M12	1.36 (3.00)
38	DN32	DM80028*3832	100.08 (3.94)	52.07 (2.05)	54.61 (2.15)	100.08 (3.94)	139.95 (5.51)	16.00 (0.63)	M16	2.24 (4.93)
42	DN32	DM80028*4232	115.06 (4.53)	57.40 (2.26)	60.45 (2.38)	100.08 (3.94)	139.95 (5.51)	16.00 (0.63)	M16	2.54 (5.59)
50	DN40	DM80028*5040	115.06 (4.53)	65.53 (2.58)	63.50 (2.50)	109.98 (4.33)	150.11 (5.91)	16.00 (0.63)	M16	2.83 (6.25)
60	DN50	DM80028*6050	145.03 (5.71)	77.22 (3.04)	88.90 (3.50)	124.97 (4.92)	165.10 (6.50)	18.03 (0.71)	M16	4.17 (9.19)

DM80028G60 is made from ASTM-A105/A350 LF2 material.

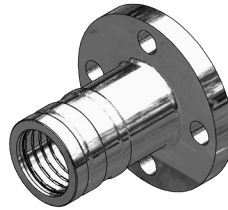
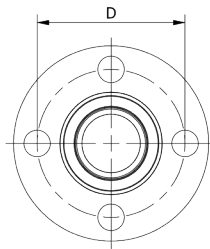
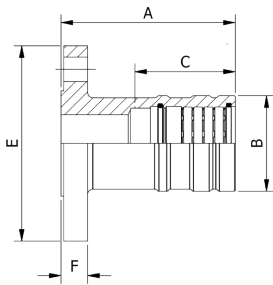

**\*MATERIAL CODE:**  
 K = STAINLESS STEEL  
 G = CARBON STEEL  
 B = COPPER NICKEL 70/30

**ORDER EXAMPLE:**  
 DM80029G2015

## Flange – PN40, Metric - DM80029

Size OD (mm)	Flange Size	Part Number	Dimensions - mm (Inch)						Bolt Size	*Weight K & G kg (lbs)
			A	B	C Insertion Depth	D	E	F		
20	DN15	DM80029*2015	80.01 (3.15)	28.70 (1.13)	37.08 (1.46)	65.02 (2.56)	95.00 (3.74)	16.00 (0.63)	M12	0.89 (1.96)
25	DN20	DM80029*2520	85.09 (3.35)	35.31 (1.39)	41.91 (1.65)	74.93 (2.95)	104.90 (4.13)	18.03 (0.71)	M12	1.27 (2.79)
30	DN25	DM80029*3025	95.00 (3.74)	41.91 (1.65)	46.99 (1.85)	85.09 (3.35)	115.06 (4.53)	18.03 (0.71)	M12	1.48 (3.26)
38	DN32	DM80029*3832	100.08 (3.94)	52.07 (2.05)	54.61 (2.15)	100.08 (3.94)	139.95 (5.51)	18.03 (0.71)	M16	2.43 (5.36)
42	DN32	DM80029*4232	115.06 (4.53)	57.40 (2.26)	60.45 (2.38)	100.08 (3.94)	139.95 (5.51)	18.03 (0.71)	M16	2.73 (6.01)
50	DN40	DM80029*5040	118.36 (4.66)	65.53 (2.58)	63.50 (2.50)	109.98 (4.33)	150.11 (5.91)	18.03 (0.71)	M16	3.01 (6.63)
60	DN50	DM80029*6050	145.03 (5.71)	77.22 (3.04)	88.90 (3.50)	124.97 (4.92)	165.10 (6.50)	20.07 (0.79)	M16	4.42 (9.74)

DM80029G60 is made from ASTM-A105/A350 LF2 material.

3D step models available upon request

# DM 80 Series - Metric Tube

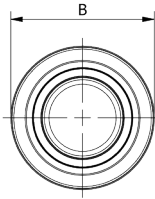
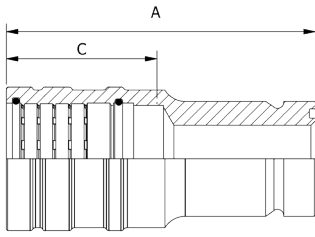

**\*MATERIAL CODE:**  
 K = STAINLESS STEEL  
 G = CARBON STEEL  
 B = COPPER NICKEL 70/30

**ORDER EXAMPLE:**  
 DM80090G1608

## SAE Flange Body, Metric - DM80090

Size OD (mm)	Flange Size	Part Number	Dimensions - mm (Inch)			*Weight K & G kg (lbs)
			A	B	C Insertion Depth	
16	1/2"	DM80090*1608	82.80 (3.26)	23.70 (0.93)	32.00 (1.26)	0.20 (0.43)
18	1/2"	DM80090*1808	82.80 (3.26)	23.70 (0.93)	35.05 (1.38)	0.20 (0.44)
20	1/2"	DM80090*2008	84.84 (3.34)	28.70 (1.13)	37.08 (1.46)	0.19 (0.42)
22	1/2"	DM80090*2208	84.84 (3.34)	30.48 (1.20)	38.10 (1.50)	0.23 (0.51)
25	3/4"	DM80090*2512	92.71 (3.65)	35.31 (1.39)	41.91 (1.65)	0.41 (0.90)
28	3/4"	DM80090*2812	95.25 (3.75)	37.59 (1.48)	44.45 (1.75)	0.42 (0.93)
30	1"	DM80090*3016	97.79 (3.85)	41.91 (1.65)	46.99 (1.85)	0.52 (1.14)
35	1"	DM80090*3516	107.95 (4.25)	46.23 (1.82)	50.80 (2.00)	0.59 (1.29)
38	1-1/4"	DM80090*3820	118.11 (4.65)	52.07 (2.05)	54.61 (2.15)	0.82 (1.80)
42	1-1/4"	DM20090*20	123.95 (4.88)	57.40 (2.26)	60.45 (2.38)	0.97 (2.13)
50	1-1/2"	DM80090*5024	136.65 (5.38)	65.53 (2.58)	63.50 (2.50)	1.41 (3.10)
**60K	2"	DM20090K32	165.10 (6.50)	77.22 (3.04)	88.90 (3.50)	2.01 (4.43)
60G	2"	DM80090G6032	165.10 (6.50)	77.22 (3.04)	88.90 (3.50)	2.01 (4.43)

\*\*2" DM 20 Series Stainless Steel fittings are also used for 60mm Stainless Steel applications.

# DM 80 Series - Metric Tube

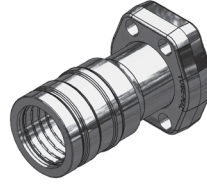
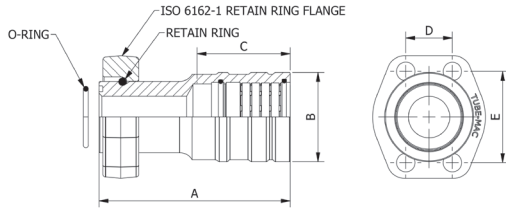

**\*MATERIAL CODE:**  
**K = STAINLESS STEEL**  
**G = CARBON STEEL**  
**B = COPPER NICKEL 70/30**

**ORDER EXAMPLE:**  
**DM80091G1608**

## ISO 6162-1 Flange, Metric - DM80091

Size OD (mm)	Flange Size	Part Number	Dimensions - mm (Inch)					Bolt Size	*Weight K & G kg (lbs)
			A	B	C Insertion Depth	D	E		
16	1/2"	DM80091*1608	82.80 (3.26)	23.70 (0.93)	32.00 (1.26)	17.53 (0.69)	38.10 (1.50)	M8	0.40 (0.89)
18	1/2"	DM80091*1808	82.80 (3.26)	25.15 (0.99)	35.05 (1.38)	17.53 (0.69)	38.10 (1.50)	M8	0.41 (0.90)
20	1/2"	DM80091*2008	84.84 (3.34)	28.70 (1.13)	37.08 (1.46)	17.53 (0.69)	38.10 (1.50)	M8	0.40 (0.88)
22	1/2"	DM80091*2208	84.84 (3.34)	30.48 (1.20)	38.10 (1.50)	17.53 (0.69)	38.10 (1.50)	M8	0.44 (0.97)
25	3/4"	DM80091*2512	92.71 (3.65)	35.31 (1.39)	41.91 (1.65)	22.35 (0.88)	47.75 (1.88)	M10	0.64 (1.40)
28	3/4"	DM80091*2812	95.25 (3.75)	37.59 (1.48)	44.45 (1.75)	22.35 (0.88)	47.75 (1.88)	M10	0.65 (1.43)
30	1"	DM80091*3016	97.79 (3.85)	41.91 (1.65)	46.99 (1.85)	26.16 (1.03)	52.32 (2.06)	M10	0.80 (1.77)
35	1"	DM80091*3516	107.95 (4.25)	46.23 (1.82)	50.80 (2.00)	26.16 (1.03)	52.32 (2.06)	M10	0.87 (1.92)
38	1-1/4"	DM80091*3820	118.11 (4.65)	52.07 (2.05)	54.61 (2.15)	30.23 (1.19)	58.67 (2.31)	M10	1.22 (2.70)
42	1-1/4"	DM20091*20	123.95 (4.88)	57.40 (2.26)	60.45 (2.38)	30.23 (1.19)	58.67 (2.31)	M10	1.37 (3.03)
50	1-1/2"	DM80091*5024	136.65 (5.38)	65.53 (2.58)	63.50 (2.50)	35.81 (1.41)	69.85 (2.75)	M12	2.02 (4.45)
**60K	2"	DM20091K32	165.10 (6.50)	77.22 (3.04)	88.90 (3.50)	42.93 (1.69)	77.22 (3.06)	M12	2.93 (6.45)
60G	2"	DM80091G6032	165.10 (6.50)	77.22 (3.04)	88.90 (3.50)	42.93 (1.69)	77.22 (3.06)	M12	2.93 (6.45)

\*\*2" DM 20 Series Stainless Steel fittings are also used for 60mm Stainless Steel applications.

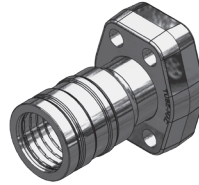
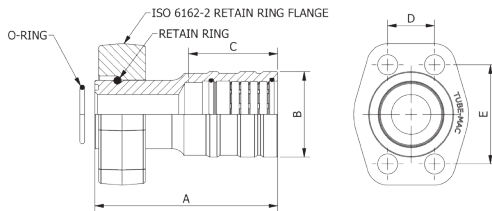

**\*MATERIAL CODE:**  
**K = STAINLESS STEEL**  
**G = CARBON STEEL**  
**B = COPPER NICKEL 70/30**

**ORDER EXAMPLE:**  
**DM80092G1608**

## ISO 6162-2 Flange, Metric - DM80092

Size OD (mm)	Flange Size	Part Number	Dimensions - mm (Inch)					Bolt Size	*Weight K & G kg (lbs)
			A	B	C Insertion Depth	D	E		
16	1/2"	DM80092*1608	82.80 (3.26)	23.70 (0.93)	32.00 (1.26)	18.29 (0.72)	40.39 (1.59)	M8	0.40 (0.89)
18	1/2"	DM80092*1808	82.80 (3.26)	25.15 (0.99)	35.05 (1.38)	18.29 (0.72)	40.39 (1.59)	M8	0.41 (0.90)
20	1/2"	DM80092*2008	84.84 (3.34)	28.70 (1.13)	37.08 (1.46)	18.29 (0.72)	40.39 (1.59)	M8	0.40 (0.88)
22	1/2"	DM80092*2208	84.84 (3.34)	30.48 (1.20)	38.10 (1.50)	18.29 (0.72)	40.39 (1.59)	M8	0.44 (0.97)
25	3/4"	DM80092*2512	92.71 (3.65)	35.31 (1.39)	41.91 (1.65)	23.88 (0.94)	50.80 (2.00)	M10	0.78 (1.71)
28	3/4"	DM80092*2812	95.25 (3.75)	37.59 (1.48)	44.45 (1.75)	23.88 (0.94)	50.80 (2.00)	M10	0.79 (1.74)
30	1"	DM80092*3016	97.79 (3.85)	41.91 (1.65)	46.99 (1.85)	27.69 (1.09)	57.15 (2.25)	M12	1.09 (2.40)
35	1"	DM80092*3516	107.95 (4.25)	46.23 (1.82)	50.80 (2.00)	27.69 (1.09)	57.15 (2.25)	M12	1.16 (2.55)
38	1-1/4"	DM80092*3820	118.11 (4.65)	52.07 (2.05)	54.61 (2.15)	31.75 (1.25)	66.80 (2.63)	M14	1.70 (3.75)
42	1-1/4"	DM20092*20	123.95 (4.88)	57.40 (2.26)	60.45 (2.38)	31.75 (1.25)	66.80 (2.63)	M14	1.85 (4.08)
50	1-1/2"	DM80092*5024	136.65 (5.38)	65.53 (2.58)	63.50 (2.50)	36.58 (1.44)	79.50 (3.13)	M16	2.71 (5.98)
**60K	2"	DM20092K32	165.10 (6.50)	77.22 (3.04)	88.90 (3.50)	44.45 (1.75)	96.77 (3.81)	M20	4.46 (9.83)
60G	2"	DM80092G6032	165.10 (6.50)	77.22 (3.04)	88.90 (3.50)	44.45 (1.75)	96.77 (3.81)	M20	4.46 (9.83)

\*\*2" DM 20 Series Stainless Steel fittings are also used for 60mm Stainless Steel applications.

3D step models available upon request



# DM 80 Series - Metric Tube

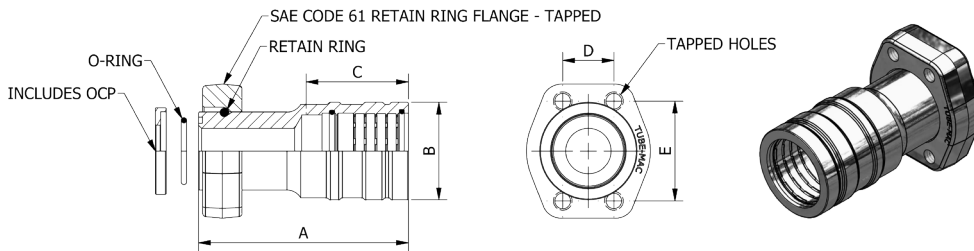

\*MATERIAL CODE:  
 K = STAINLESS STEEL  
 G = CARBON STEEL  
 B = COPPER NICKEL 70/30

ORDER EXAMPLE:  
 DM80095G1608

## ISO 6162-1 Tapped Flange, Metric - DM80095

Size OD (mm)	Flange Size	Part Number	Dimensions - mm (Inch)					Metric Tap	*Weight K & G kg (lbs)
			A	B	C Insertion Depth	D	E		
16	1/2"	DM80095*1608	82.80 (3.26)	23.70 (0.93)	32.00 (1.26)	17.53 (0.69)	38.10 (1.50)	M8	0.40 (0.89)
18	1/2"	DM80095*1808	82.80 (3.26)	25.15 (0.99)	35.05 (1.38)	17.53 (0.69)	38.10 (1.50)	M8	0.41 (0.90)
20	1/2"	DM80095*2008	84.84 (3.34)	28.70 (1.13)	37.08 (1.46)	17.53 (0.69)	38.10 (1.50)	M8	0.40 (0.88)
22	1/2"	DM80095*2208	84.84 (3.34)	30.48 (1.20)	38.10 (1.50)	17.53 (0.69)	38.10 (1.50)	M8	0.44 (0.97)
25	3/4"	DM80095*2512	92.71 (3.65)	35.31 (1.39)	41.91 (1.65)	22.35 (0.88)	47.75 (1.88)	M10	0.64 (1.40)
28	3/4"	DM80095*2812	95.25 (3.75)	37.59 (1.48)	44.45 (1.75)	22.35 (0.88)	47.75 (1.88)	M10	0.65 (1.43)
30	1"	DM80095*3016	97.79 (3.85)	41.91 (1.65)	46.99 (1.85)	26.16 (1.03)	52.32 (2.06)	M10	0.80 (1.77)
35	1"	DM80095*3516	107.95 (4.25)	46.23 (1.82)	50.80 (2.00)	26.16 (1.03)	52.32 (2.06)	M10	0.87 (1.92)
38	1-1/4"	DM80095*3820	118.11 (4.65)	52.07 (2.05)	54.61 (2.15)	30.23 (1.19)	58.67 (2.31)	M10	1.22 (2.70)
42	1-1/4"	DM80095*4220	123.95 (4.88)	57.40 (2.26)	60.45 (2.38)	30.23 (1.19)	58.67 (2.31)	M10	1.37 (3.03)
50	1-1/2"	DM80095*5024	136.65 (5.38)	65.53 (2.58)	63.50 (2.50)	35.81 (1.41)	69.85 (2.75)	M12	2.02 (4.45)
**60K	2"	DM80095K6032	165.10 (6.50)	77.22 (3.04)	88.90 (3.50)	42.93 (1.69)	77.22 (3.06)	M12	2.93 (6.45)
60G	2"	DM80095G6032	165.10 (6.50)	77.22 (3.04)	88.90 (3.50)	42.93 (1.69)	77.22 (3.06)	M12	2.93 (6.45)

\*\*2" DM 20 Series Stainless Steel fittings are also used for 60mm Stainless Steel applications.

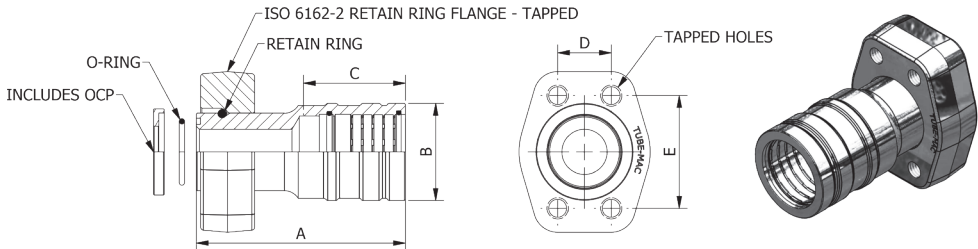

\*MATERIAL CODE:  
 K = STAINLESS STEEL  
 G = CARBON STEEL  
 B = COPPER NICKEL 70/30

ORDER EXAMPLE:  
 DM80096G1608

## ISO 6162-2 Tapped Flange, Metric - DM80096

Size OD (mm)	Flange Size	Part Number	Dimensions - mm (Inch)					Metric Tap	*Weight K & G kg (lbs)
			A	B	C Insertion Depth	D	E		
16	1/2"	DM80096*1608	82.80 (3.26)	23.70 (0.93)	32.00 (1.26)	18.29 (0.72)	40.39 (1.59)	M8	0.40 (0.89)
18	1/2"	DM80096*1808	82.80 (3.26)	25.15 (0.99)	35.05 (1.38)	18.29 (0.72)	40.39 (1.59)	M8	0.41 (0.90)
20	1/2"	DM80096*2008	84.84 (3.34)	28.70 (1.13)	37.08 (1.46)	18.29 (0.72)	40.39 (1.59)	M8	0.40 (0.88)
22	1/2"	DM80096*2208	84.84 (3.34)	30.48 (1.20)	38.10 (1.50)	18.29 (0.72)	40.39 (1.59)	M8	0.44 (0.97)
25	3/4"	DM80096*2512	92.71 (3.65)	35.31 (1.39)	41.91 (1.65)	23.88 (0.94)	50.80 (2.00)	M10	0.78 (1.71)
28	3/4"	DM80096*2812	95.25 (3.75)	37.59 (1.48)	44.45 (1.75)	23.88 (0.94)	50.80 (2.00)	M10	0.79 (1.74)
30	1"	DM80096*3016	97.79 (3.85)	41.91 (1.65)	46.99 (1.85)	27.69 (1.09)	57.15 (2.25)	M12	1.09 (2.40)
35	1"	DM80096*3516	107.95 (4.25)	46.23 (1.82)	50.80 (2.00)	27.69 (1.09)	57.15 (2.25)	M12	1.16 (2.55)
38	1-1/4"	DM80096*3820	118.11 (4.65)	52.07 (2.05)	54.61 (2.15)	31.75 (1.25)	66.80 (2.63)	M14	1.70 (3.75)
42	1-1/4"	DM80096*4220	123.95 (4.88)	57.40 (2.26)	60.45 (2.38)	31.75 (1.25)	66.80 (2.63)	M14	1.85 (4.08)
50	1-1/2"	DM80096*5024	136.65 (5.38)	65.53 (2.58)	63.50 (2.50)	36.58 (1.44)	79.50 (3.13)	M16	2.71 (5.98)
**60K	2"	DM80096K6032	165.10 (6.50)	77.22 (3.04)	88.90 (3.50)	44.45 (1.75)	96.77 (3.81)	M20	4.46 (9.83)
60G	2"	DM80096G6032	165.10 (6.50)	77.22 (3.04)	88.90 (3.50)	44.45 (1.75)	96.77 (3.81)	M20	4.46 (9.83)

\*\*2" DM 20 Series Stainless Steel fittings are also used for 60mm Stainless Steel applications.

3D step models available upon request

# DM 80 Series - Metric Tube

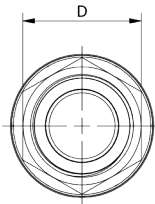
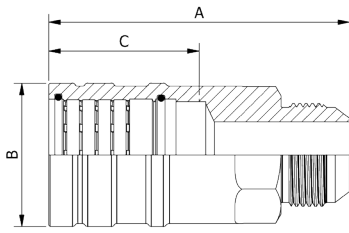

**\*MATERIAL CODE:**  
**K = STAINLESS STEEL**  
**G = CARBON STEEL**  
**B = COPPER NICKEL 70/30**

**ORDER EXAMPLE:**  
**DM80055G0604**

## JIC 37° Male, Metric - DM80055

Size OD (mm)	JIC Size	Part Number	Dimensions - mm (Inch)				*Weight K & G kg (lbs)
			A	B	C Insertion Depth	D	
6	04	DM80055*0604	42.67 (1.68)	9.80 (0.39)	16.51 (0.65)	12.70 (0.50)	0.02 (0.04)
8	04	DM80055*0804	46.48 (1.83)	12.19 (0.48)	19.30 (0.76)	12.70 (0.50)	0.03 (0.05)
10	06	DM80055*1006	49.53 (1.95)	15.09 (0.59)	24.13 (0.95)	16.00 (0.63)	0.04 (0.08)
12	08	DM80055*1208	60.45 (2.38)	18.59 (0.73)	26.92 (1.06)	22.10 (0.87)	0.08 (0.18)
16	10	DM80055*1610	66.80 (2.63)	23.70 (0.93)	32.00 (1.26)	26.92 (1.06)	0.12 (0.27)
20	12	DM80055*2012	84.58 (3.33)	28.70 (1.13)	37.08 (1.46)	28.70 (1.13)	0.15 (0.33)
25	16	DM80055*2516	89.92 (3.54)	35.31 (1.39)	41.91 (1.65)	35.05 (1.38)	0.31 (0.69)
30	20	DM80055*3020	101.60 (4.00)	41.91 (1.65)	46.99 (1.85)	47.75 (1.88)	0.54 (1.18)
38	24	DM80055*3824	117.60 (4.63)	52.07 (2.05)	54.61 (2.15)	50.80 (2.00)	0.82 (1.81)
42	24	DM80055*4224	117.60 (4.63)	57.40 (2.26)	60.45 (2.38)	57.15 (2.25)	1.04 (2.29)
50	24	DM80055*5024	127.00 (5.00)	65.53 (2.58)	63.50 (2.50)	66.80 (2.63)	1.32 (2.91)

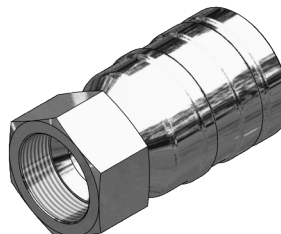
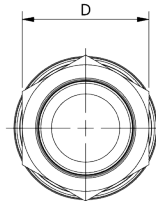
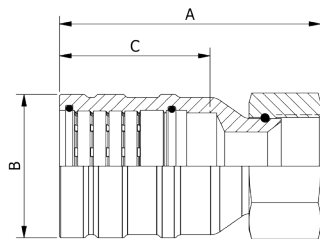

**\*MATERIAL CODE:**  
**K = STAINLESS STEEL**  
**G = CARBON STEEL**  
**B = COPPER NICKEL 70/30**

**ORDER EXAMPLE:**  
**DM80054G0604**

## JIC 37° Female Swivel, Metric - DM80054

Size OD (mm)	JIC Size	Part Number	Dimensions - mm (Inch)				*Weight K & G kg (lbs)
			A	B	C Insertion Depth	D	
6	04	DM80054*0604	42.42 (1.67)	9.80 (0.39)	16.51 (0.65)	14.22 (0.56)	0.02 (0.05)
8	04	DM80054*0804	42.42 (1.67)	12.19 (0.48)	19.30 (0.76)	14.22 (0.56)	0.03 (0.06)
10	06	DM80054*1006	48.01 (1.91)	15.09 (0.59)	24.13 (0.95)	17.53 (0.69)	0.04 (0.09)
12	08	DM80054*1208	57.65 (2.27)	18.59 (0.73)	26.92 (1.06)	22.35 (0.88)	0.07 (0.16)
16	10	DM80054*1610	62.74 (2.47)	23.70 (0.93)	32.00 (1.26)	25.40 (1.00)	0.11 (0.25)
20	12	DM80054*2012	78.74 (3.10)	28.70 (1.13)	37.08 (1.46)	31.75 (1.25)	0.22 (0.48)
25	16	DM80054*2516	81.28 (3.20)	35.31 (1.39)	41.91 (1.65)	38.10 (1.50)	0.29 (0.65)
30	20	DM80054*3020	92.20 (3.63)	41.91 (1.65)	46.99 (1.85)	50.80 (2.00)	0.56 (1.24)
38	24	DM80054*3824	114.30 (4.50)	52.07 (2.05)	54.61 (2.15)	57.15 (2.25)	0.95 (2.10)
42	24	DM80054*4224	123.95 (4.88)	57.40 (2.26)	60.45 (2.38)	57.15 (2.25)	1.13 (2.49)
50	24	DM80054*5024	128.02 (5.04)	65.53 (2.58)	63.50 (2.50)	83.82 (3.30)	1.59 (3.51)

3D step models available upon request

# DM 80 Series - Metric Tube

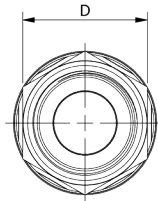
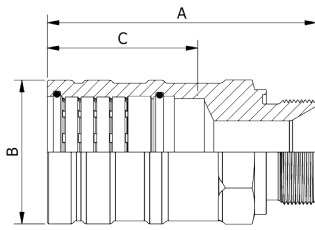

**\*MATERIAL CODE:**  
**K = STAINLESS STEEL**  
**G = CARBON STEEL**  
**B = COPPER NICKEL 70/30**

**ORDER EXAMPLE:**  
**DM80153G0604**

## BSPP Male, Metric - DM80153

Size OD (mm)	BSPP Size	Part Number	Dimensions - mm (Inch)				*Weight K & G kg (lbs)
			A	B	C Insertion Depth	D	
6	1/4"	DM80153*0604	43.43 (1.71)	9.80 (0.39)	16.51 (0.65)	19.05 (0.75)	0.03 (0.07)
8	1/4"	DM80153*0804	45.97 (1.81)	12.19 (0.48)	19.30 (0.76)	19.05 (0.75)	0.04 (0.08)
10	1/4"	DM80153*1004	51.05 (2.01)	15.09 (0.59)	24.13 (0.95)	19.05 (0.75)	0.05 (0.10)
12	1/4"	DM80153*1204	53.84 (2.12)	18.59 (0.73)	26.92 (1.06)	19.05 (0.75)	0.05 (0.12)
15	3/8"	DM80153*1506	58.93 (2.32)	23.70 (0.93)	32.00 (1.26)	22.10 (0.87)	0.10 (0.22)
16	3/8"	DM80153*1606	58.93 (2.32)	23.70 (0.93)	32.00 (1.26)	22.10 (0.87)	0.09 (0.20)
18	3/8"	DM80153*1806	61.98 (2.44)	25.15 (0.99)	35.05 (1.38)	22.10 (0.87)	0.12 (0.27)
20	1/2"	DM80153*2008	66.29 (2.61)	28.70 (1.13)	37.08 (1.46)	29.97 (1.18)	0.15 (0.34)
22	1/2"	DM80153*2208	72.14 (2.84)	30.48 (1.20)	38.10 (1.50)	32.00 (1.26)	0.18 (0.40)
25	3/4"	DM80153*2512	83.06 (3.27)	35.31 (1.39)	41.91 (1.65)	36.07 (1.42)	0.28 (0.62)
28	3/4"	DM80153*2812	85.60 (3.37)	37.59 (1.48)	44.45 (1.75)	36.07 (1.42)	0.33 (0.72)
30	1"	DM80153*3016	85.09 (3.35)	41.91 (1.65)	46.99 (1.85)	45.97 (1.80)	0.43 (0.94)
35	1"	DM80153*3516	88.90 (3.50)	46.23 (1.82)	50.80 (2.00)	50.04 (1.97)	0.50 (1.11)
38	1-1/4"	DM80153*3820	109.73 (4.32)	52.07 (2.05)	54.61 (2.15)	56.13 (2.21)	0.95 (2.10)
42	1-1/4"	DM20153*20	107.95 (4.25)	57.40 (2.26)	60.45 (2.38)	50.04 (1.97)	0.88 (1.95)
50	1-1/2"	DM80153*5024	115.57 (4.55)	65.53 (2.58)	63.50 (2.50)	55.12 (2.17)	1.15 (2.53)
**60K	2"	DM20153K32	136.65 (5.38)	77.22 (3.04)	88.90 (3.50)	74.93 (2.95)	1.58 (3.49)
60G	2"	DM80153G6032	136.65 (5.38)	77.22 (3.04)	88.90 (3.50)	74.93 (2.95)	1.58 (3.49)

\*\*2" DM 20 Series Stainless Steel fittings are also used for 60mm Stainless Steel applications.

# DM 80 Series - Metric Tube

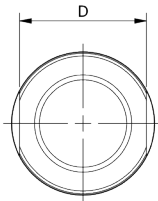
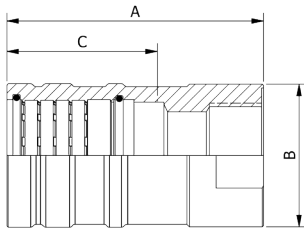

**\*MATERIAL CODE:**  
**K = STAINLESS STEEL**  
**G = CARBON STEEL**  
**B = COPPER NICKEL 70/30**

**ORDER EXAMPLE:**  
**DM80086G0604**

## BSPP Female, Metric - DM80086

Size OD (mm)	BSPP Size	Part Number	Dimensions - mm (Inch)				*Weight K & G kg (lbs)
			A	B	C Insertion Depth	D	
6	1/4"	DM80086*0604	42.16 (1.66)	23.88 (0.94)	16.51 (0.65)	20.07 (0.79)	0.05 (0.10)
8	1/4"	DM80086*0804	44.70 (1.76)	23.88 (0.94)	19.30 (0.76)	20.07 (0.79)	0.05 (0.11)
10	1/4"	DM80086*1004	49.78 (1.96)	23.88 (0.94)	24.13 (0.95)	20.07 (0.79)	0.06 (0.14)
12	1/4"	DM80086*1204	51.82 (2.04)	23.88 (0.94)	26.92 (1.06)	20.07 (0.79)	0.07 (0.16)
15	3/8"	DM80086*1506	57.40 (2.26)	26.92 (1.06)	32.00 (1.26)	22.10 (0.87)	0.06 (0.13)
16	3/8"	DM80086*1606	57.40 (2.26)	26.92 (1.06)	32.00 (1.26)	22.10 (0.87)	0.06 (0.13)
18	3/8"	DM80086*1806	57.40 (2.26)	26.92 (1.06)	35.05 (1.38)	22.10 (0.87)	0.11 (0.24)
20	1/2"	DM80086*2008	75.18 (2.96)	34.29 (1.35)	37.08 (1.46)	30.23 (1.19)	0.26 (0.57)
22	1/2"	DM80086*2208	73.15 (2.88)	34.29 (1.35)	38.10 (1.50)	30.23 (1.19)	0.23 (0.51)
25	3/4"	DM80086*2512	89.92 (3.54)	38.10 (1.50)	41.91 (1.65)	37.75 (1.25)	0.38 (0.83)
28	3/4"	DM80086*2812	89.92 (3.54)	38.10 (1.50)	41.91 (1.65)	37.75 (1.25)	0.38 (0.84)
30	1"	DM80086*3016	98.55 (3.88)	47.75 (1.88)	46.99 (1.85)	41.40 (1.63)	0.57 (1.25)
35	1"	DM80086*3516	98.55 (3.88)	47.75 (1.88)	50.80 (2.00)	41.40 (1.63)	0.60 (1.32)
38	1-1/4"	DM80086*3820	113.28 (4.46)	57.15 (2.25)	54.61 (2.15)	50.80 (2.00)	1.03 (2.27)
42	1-1/4"	DM20086*20	102.87 (4.05)	57.15 (2.25)	60.45 (2.38)	50.80 (2.00)	0.87 (1.91)
50	1-1/2"	DM80086*5024	114.30 (4.50)	69.85 (2.75)	63.50 (2.50)	63.50 (2.50)	1.36 (3.00)
**60K	2"	DM20086K32	146.05 (5.75)	88.90 (3.50)	88.90 (3.50)	76.20 (3.00)	2.33 (5.14)
60G	2"	DM80086G6032	146.05 (5.75)	88.90 (3.50)	88.90 (3.50)	76.20 (3.00)	2.33 (5.14)

\*\*2" DM 20 Series Stainless Steel fittings are also used for 60mm Stainless Steel applications.

# DM 80 Series - Metric Tube

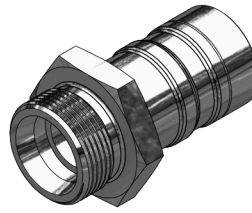
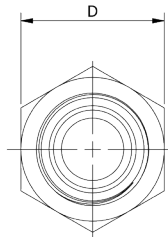
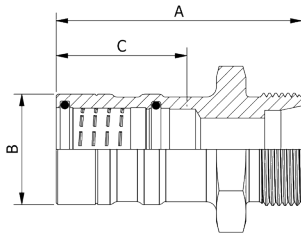

**\*MATERIAL CODE:**  
**K = STAINLESS STEEL**  
**G = CARBON STEEL**  
**B = COPPER NICKEL 70/30**

**ORDER EXAMPLE:**  
**DM80066G06S**

## DIN 24° Male, Metric - DM80066

Size OD (mm)	DIN 2353/ISO 8434-1 L & S Series Thread	Part Number	Dimensions - mm (Inch)				*Weight K & G kg (lbs)
			A	B	C Insertion Depth	D	
6	6L - M12 x 1.5	DM80066*06L	38.86 (1.53)	9.80 (0.39)	16.51 (0.65)	13.97 (0.55)	0.02 (0.05)
6	6S - M14 x 1.5	DM80066*06S	38.86 (1.53)	9.80 (0.39)	16.51 (0.65)	17.02 (0.67)	0.03 (0.06)
8	8L - M14 x 1.5	DM80066*08L	50.55 (1.99)	12.19 (0.48)	19.30 (0.76)	17.02 (0.67)	0.04 (0.09)
8	8S - M16 x 1.5	DM80066*08S	53.09 (2.09)	12.19 (0.48)	19.30 (0.76)	17.02 (0.67)	0.05 (0.10)
10	10L - M16 x 1.5	DM80066*10L	54.61 (2.15)	15.09 (0.59)	24.13 (0.95)	19.05 (0.75)	0.05 (0.12)
10	10S - M18 x 1.5	DM80066*10S	57.66 (2.27)	15.09 (0.59)	24.13 (0.95)	22.10 (0.87)	0.07 (0.16)
12	12L - M18 x 1.5	DM80066*12L	52.07 (2.05)	18.59 (0.73)	26.92 (1.06)	24.13 (0.95)	0.07 (0.17)
12	12S - M20 x 1.5	DM80066*12S	56.64 (2.23)	18.59 (0.73)	26.92 (1.06)	22.10 (0.87)	0.08 (0.18)
15	15L - M22 x 1.5	DM80066*15L	57.40 (2.26)	23.70 (0.93)	32.00 (1.26)	26.92 (1.06)	0.10 (0.27)
16	16S - M24 x 1.5	DM80066*16S	62.99 (2.48)	23.70 (0.93)	32.00 (1.26)	26.92 (1.06)	0.14 (0.31)
18	18L - M26 x 1.5	DM80066*18L	60.45 (2.38)	25.15 (0.99)	35.05 (1.38)	32.00 (1.26)	0.14 (0.31)
20	20S - M30 x 2.0	DM80066*20S	67.82 (2.67)	28.70 (1.13)	37.08 (1.46)	36.07 (1.42)	0.22 (0.48)
22	22L - M30 x 2.0	DM80066*22L	68.58 (2.70)	30.48 (1.20)	38.10 (1.50)	36.07 (1.42)	0.22 (0.48)
25	25S - M36 x 2.0	DM80066*25S	78.74 (3.10)	35.31 (1.39)	41.91 (1.65)	45.97 (1.81)	0.34 (0.76)
28	28L - M36 x 2.0	DM80066*28L	82.04 (3.23)	37.59 (1.48)	44.45 (1.75)	40.89 (1.61)	0.30 (0.67)
30	30S - M42 x 2.0	DM80066*30S	85.60 (3.37)	41.91 (1.65)	46.99 (1.85)	50.04 (1.97)	0.48 (1.05)
35	35L - M45 x 2.0	DM80066*35L	85.09 (3.35)	46.23 (1.82)	50.80 (2.00)	50.04 (1.97)	0.49 (1.09)
38	38S - M52 x 2.0	DM80066*38S	100.84 (3.97)	52.07 (2.05)	54.61 (2.15)	59.94 (2.36)	0.84 (1.85)
42	42L - M52 x 2.0	DM80066*42L	95.50 (3.76)	57.40 (2.26)	60.45 (2.38)	59.94 (2.36)	0.81 (1.79)

# DM 80 Series - Metric Tube

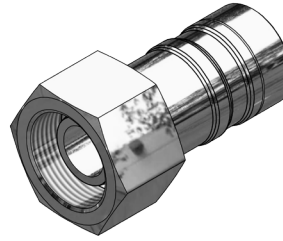
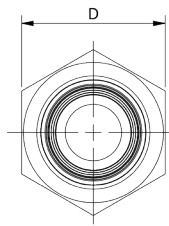
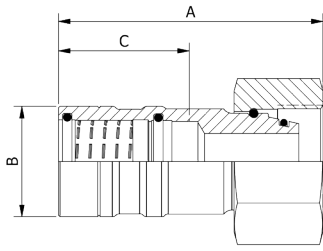

**\*MATERIAL CODE:**  
**K = STAINLESS STEEL**  
**G = CARBON STEEL**  
**B = COPPER NICKEL 70/30**

**ORDER EXAMPLE:**  
**DM80068G06S**

## DIN 24° Female Swivel, Metric - DM80068

Size OD (mm)	DIN 2353/ISO 8434-1 L & S Series Thread	Part Number	Dimensions - mm (Inch)				*Weight K & G kg (lbs)
			A	B	C Insertion Depth	D	
6	6L - M12 x 1.5	DM80068*06L	39.00 (1.54)	9.80 (0.39)	16.51 (0.65)	13.97 (0.55)	0.03 (0.06)
6	6S - M14 x 1.5	DM80068*06S	42.42 (1.67)	9.80 (0.39)	16.51 (0.65)	17.02 (0.67)	0.03 (0.07)
8	8L - M12 x 1.5	DM80068*08L	42.93 (1.69)	12.19 (0.48)	19.30 (0.76)	17.02 (0.67)	0.04 (0.08)
8	8S - M16 x 1.5	DM80068*08S	48.26 (1.90)	12.19 (0.48)	19.30 (0.76)	18.80 (0.74)	0.05 (0.10)
10	10L - M16 x 1.5	DM80068*10L	51.31 (2.02)	15.09 (0.59)	24.13 (0.95)	18.80 (0.74)	0.05 (0.11)
10	10S - M18 x 1.5	DM80068*10S	51.56 (2.03)	15.09 (0.59)	24.13 (0.95)	21.84 (0.86)	0.06 (0.14)
12	12L - M18 x 1.5	DM80068*12L	53.85 (2.12)	18.59 (0.73)	26.92 (1.06)	21.84 (0.86)	0.07 (0.16)
12	12S - M20 x 1.5	DM80068*12S	52.58 (2.07)	18.59 (0.73)	26.92 (1.06)	23.62 (0.93)	0.09 (0.19)
15	15L - M22 x 1.5	DM80068*15L	61.98 (2.44)	23.70 (0.93)	32.00 (1.26)	26.92 (1.06)	0.14 (0.30)
16	16S - M24 x 1.5	DM80068*16S	60.45 (2.38)	23.70 (0.93)	32.00 (1.26)	29.72 (1.17)	0.15 (0.32)
18	18L - M26 x 1.5	DM80068*18L	65.53 (2.58)	25.15 (0.99)	35.05 (1.38)	32.00 (1.26)	0.17 (0.37)
20	20S - M30 x 2.0	DM80068*20S	68.33 (2.69)	28.70 (1.13)	37.08 (1.46)	35.81 (1.41)	0.21 (0.47)
22	22L - M30 x 2.0	DM80068*22L	73.15 (2.88)	30.48 (1.20)	38.10 (1.50)	35.81 (1.41)	0.25 (0.56)
25	25S - M36 x 2.0	DM80068*25S	84.84 (3.34)	35.31 (1.39)	41.91 (1.65)	45.72 (1.80)	0.45 (1.00)
28	28L - M36 x 2.0	DM80068*28L	76.96 (3.03)	37.59 (1.48)	44.45 (1.75)	40.89 (1.61)	0.32 (0.70)
30	30S - M42 x 2.0	DM80068*30S	89.92 (3.54)	41.91 (1.65)	46.99 (1.85)	49.78 (1.96)	0.53 (1.17)
35	35L - M45 x 2.0	DM80068*35L	92.96 (3.66)	46.23 (1.82)	50.80 (2.00)	50.04 (1.97)	0.55 (1.22)
38	38S - M52 x 2.0	DM80068*38S	105.41 (4.15)	52.07 (2.05)	54.61 (2.15)	59.69 (2.35)	0.98 (2.16)
42	42L - M52 x 2.0	DM80068*42L	107.44 (4.23)	57.40 (2.26)	60.45 (2.38)	60.20 (2.37)	1.03 (2.27)

# DM 80 Series - Metric Tube

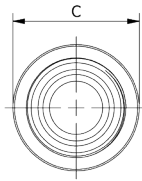
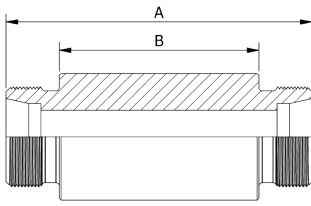

\*MATERIAL CODE:  
 K = STAINLESS STEEL  
 G = CARBON STEEL  
 B = COPPER NICKEL 70/30

ORDER EXAMPLE:  
 DM80089G06S

## Weldable Bulkhead, Metric - DM80089

Size OD (mm)	DIN 2353/ISO 8434-1 L & S Series Thread	Part Number	Dimensions - mm (Inch)			*Weight K & G kg (lbs)
			A	B	C	
6	6L - M12 x 1.5	DM80089*06L	73.91 (2.91)	49.78 (1.96)	20.00 (0.79)	0.14 (0.30)
6	6S - M14 x 1.5	DM80089*06S	73.91 (2.91)	49.78 (1.96)	20.00 (0.79)	0.14 (0.30)
8	8L - M14 x 1.5	DM80089*08L	73.91 (2.91)	48.01 (1.89)	22.00 (0.87)	0.17 (0.37)
8	8S - M16 x 1.5	DM80089*08S	73.91 (2.91)	53.09 (2.09)	22.00 (0.87)	0.16 (0.36)
10	10L - M16 x 1.5	DM80089*10L	73.91 (2.91)	50.04 (1.97)	25.00 (0.98)	0.21 (0.46)
10	10S - M18 x 1.5	DM80089*10S	73.91 (2.91)	52.07 (2.05)	25.00 (0.98)	0.20 (0.45)
12	12L - M18 x 1.5	DM80089*12L	73.91 (2.91)	50.04 (1.97)	25.00 (0.98)	0.18 (0.40)
12	12S - M20 x 1.5	DM80089*12S	73.91 (2.91)	51.82 (2.04)	28.00 (1.10)	0.25 (0.56)
15	15L - M22 x 1.5	DM80089*15L	84.07 (3.31)	59.94 (2.36)	28.00 (1.10)	0.27 (0.59)
16	16S - M24 x 1.5	DM80089*16S	88.14 (3.47)	59.94 (2.36)	35.00 (1.38)	0.45 (0.99)
18	18L - M26 x 1.5	DM80089*18L	84.07 (3.31)	59.94 (2.36)	32.00 (1.26)	0.34 (0.75)
20	20S - M30 x 2.0	DM80089*20S	91.95 (3.62)	59.94 (2.36)	38.00 (1.50)	0.52 (1.15)
22	22L - M30 x 2.0	DM80089*22L	87.88 (3.46)	59.94 (2.36)	36.00 (1.42)	0.40 (0.89)
25	25S - M36 x 2.0	DM80089*25S	96.01 (3.78)	59.94 (2.36)	45.00 (1.77)	0.73 (1.61)
28	28L - M36 x 2.0	DM80089*28L	87.88 (3.46)	59.94 (2.36)	40.00 (1.58)	0.45 (1.00)
30	30S - M42 x 2.0	DM80089*30S	99.82 (3.93)	59.94 (2.36)	50.00 (1.97)	0.88 (1.95)
35	35L - M45 x 2.0	DM80089*35L	91.95 (3.62)	59.94 (2.36)	50.00 (1.97)	0.73 (1.62)
38	38S - M52 x 2.0	DM80089*38S	103.89 (4.09)	59.94 (2.36)	60.00 (2.36)	1.26 (2.77)
42	42L - M52 x 2.0	DM80089*42L	91.95 (3.62)	59.94 (2.36)	60.00 (2.36)	1.02 (2.24)

# DM 80 Series - Metric Tube

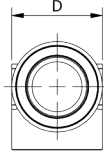
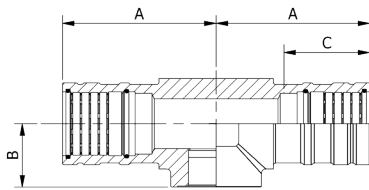

**\*MATERIAL CODE:**  
**K = STAINLESS STEEL**  
**G = CARBON STEEL**  
**B = COPPER NICKEL 70/30**

**ORDER EXAMPLE:**  
**DM80172G1004**

## BSPF Female Branch Tee, Metric - DM80172

Size OD (mm)	BSPP Size	Part Number	Dimensions - mm (Inch)				*Weight K & G kg (lbs)
			A	B	C Insertion Depth	D	
10	1/4"	DM80172*1004	46.99 (1.85)	20.83 (0.82)	24.13 (0.95)	21.84 (0.86)	0.15 (0.33)
12	1/4"	DM80172*1204	47.75 (1.88)	20.83 (0.82)	26.92 (1.06)	26.92 (1.06)	0.14 (0.30)
15	3/8"	DM80172*1506	52.07 (2.05)	22.35 (0.88)	32.00 (1.26)	26.16 (1.03)	0.27 (0.60)
16	3/8"	DM80172*1606	52.07 (2.05)	22.35 (0.88)	32.00 (1.26)	26.16 (1.03)	0.25 (0.55)
18	3/8"	DM80172*1806	52.07 (2.05)	22.35 (0.88)	35.05 (1.38)	26.16 (1.03)	0.24 (0.52)
20	1/2"	DM80172*2008	73.15 (2.88)	25.40 (1.00)	37.08 (1.46)	33.02 (1.30)	0.38 (0.84)
22	1/2"	DM80172*2208	73.15 (2.88)	25.40 (1.00)	38.10 (1.50)	33.02 (1.30)	0.57 (1.25)
25	3/4"	DM80172*2512	76.92 (3.03)	28.70 (1.13)	41.91 (1.65)	40.13 (1.58)	0.75 (1.60)
28	3/4"	DM80172*2812	76.92 (3.03)	28.70 (1.13)	44.45 (1.75)	40.13 (1.58)	0.71 (1.57)
30	1"	DM80172*3016	85.60 (3.37)	38.10 (1.50)	46.99 (1.85)	50.04 (1.97)	1.22 (2.70)
35	1"	DM80172*3516	85.60 (3.37)	38.10 (1.50)	50.80 (2.00)	50.04 (1.97)	1.27 (2.80)
38	1-1/4"	DM80172*3820	107.95 (4.25)	41.40 (1.63)	54.61 (2.15)	63.50 (2.50)	2.51 (5.53)
42	1-1/4"	DM20172*20	107.95 (4.25)	44.45 (1.75)	60.45 (2.38)	63.50 (2.50)	2.67 (5.89)
50	1-1/2"	DM80172*5024	115.32 (4.54)	44.45 (1.75)	63.50 (2.50)	71.37 (2.81)	3.13 (6.90)
**60K	2"	DM20172K32	138.43 (5.45)	60.45 (2.38)	88.90 (3.50)	82.55 (3.25)	4.75 (10.48)
60G	2"	DM80172G6032	138.43 (5.45)	60.45 (2.38)	88.90 (3.50)	82.55 (3.25)	4.75 (10.48)

\*\*2" DM 20 Series Stainless Steel fittings are also used for 60mm Stainless Steel applications.

3D step models available upon request



# DM 80 Series - Metric Tube

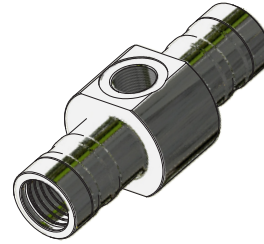
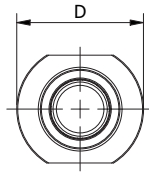
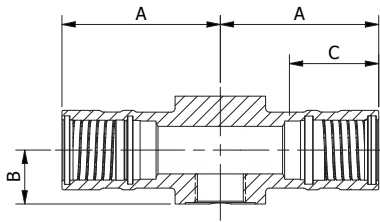

\*MATERIAL CODE:  
K = STAINLESS STEEL

ORDER EXAMPLE:  
DM80211K2004

## BSPP Female Branch Tee, Metric - DM80211

Size OD (mm)	BSPP Size	Part Number	Dimensions - mm (Inch)				Weight K kg (lbs)
			A	B	C Insertion Depth	D	
20	1/4"	DM80211K2004	63.50 (2.50)	20.02 (0.79)	37.08 (1.46)	44.45 (1.75)	0.46 (1.02)
20	3/8"	DM80211K2006	50.80 (2.20)	20.02 (0.79)	37.08 (1.46)	47.63 (1.88)	0.52 (1.14)
22	1/4"	DM80211K2204	63.50 (2.50)	20.02 (0.79)	38.10 (1.50)	44.45 (1.75)	0.46 (1.02)
22	3/8"	DM80211K2206	65.08 (2.56)	20.02 (0.79)	38.10 (1.50)	47.63 (1.88)	0.53 (1.16)
25	1/4"	DM80211K2504	63.50 (2.50)	20.02 (0.79)	41.91 (1.65)	44.45 (1.75)	0.55 (1.22)
25	3/8"	DM80211K2506	65.08 (2.56)	20.02 (0.79)	41.91 (1.65)	47.63 (1.88)	0.62 (1.36)
25	1/2"	DM80211K2508	66.68 (2.63)	23.01 (0.91)	41.91 (1.65)	53.98 (2.13)	0.76 (1.67)
28	1/4"	DM80211K2804	66.68 (2.63)	20.02 (0.79)	44.45 (1.75)	44.45 (1.75)	0.58 (1.27)
28	3/8"	DM80211K2806	68.25 (2.69)	21.08 (0.83)	44.45 (1.75)	47.63 (1.88)	0.63 (1.38)
28	1/2"	DM80211K2808	69.85 (2.75)	23.01 (0.91)	44.45 (1.75)	53.98 (2.13)	0.75 (1.66)
30	1/4"	DM80211K3004	71.44 (2.81)	21.44 (0.84)	46.99 (1.85)	47.63 (1.88)	0.78 (1.72)
30	3/8"	DM80211K3006	73.02 (2.88)	21.08 (0.83)	46.99 (1.85)	47.63 (1.88)	0.80 (1.77)
30	1/2"	DM80211K3008	74.63 (2.94)	23.01 (0.91)	46.99 (1.85)	53.98 (2.13)	0.93 (2.05)
35	1/4"	DM80211K3504	72.24 (2.84)	25.40 (1.00)	50.80 (2.00)	53.98 (2.13)	0.85 (1.87)
35	3/8"	DM80211K3506	73.81 (2.91)	24.61 (0.97)	50.80 (2.00)	53.98 (2.13)	0.88 (1.94)
35	1/2"	DM80211K3508	75.41 (2.97)	24.61 (0.97)	50.80 (2.00)	57.15 (2.25)	0.97 (2.13)
38	1/4"	DM80211K3804	80.98 (3.19)	26.19 (1.03)	54.61 (2.15)	57.15 (2.25)	1.32 (2.92)
38	3/8"	DM80211K3806	82.55 (3.25)	26.19 (1.03)	54.61 (2.15)	57.15 (2.25)	1.36 (3.00)
38	1/2"	DM80211K3808	84.15 (3.31)	27.79 (1.09)	54.61 (2.15)	63.50 (2.50)	1.52 (3.35)
42	3/8"	DM20211K2006	82.55 (3.25)	29.36 (1.16)	60.45 (2.38)	63.50 (2.50)	1.53 (3.38)
42	1/2"	DM20211K2008	84.15 (3.31)	28.58 (1.13)	60.45 (2.38)	63.50 (2.50)	1.56 (3.43)
60	3/8"	DM20211K3206	107.95 (4.25)	38.10 (1.50)	88.90 (3.50)	81.28 (3.20)	2.88 (6.35)
60	1/2"	DM20211K3208	139.47 (4.31)	38.10 (1.50)	88.90 (3.50)	81.28 (3.20)	2.95 (6.50)

**Note:** Only available in Stainless Steel.

# DM 80 Series - Metric Tube

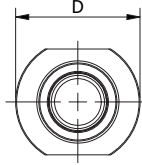
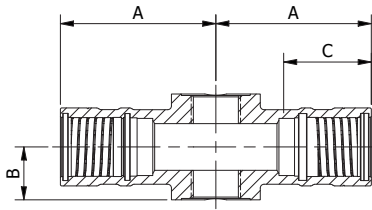

\*MATERIAL CODE:  
K = STAINLESS STEEL

ORDER EXAMPLE:  
DM80221K2004

## BSPP (2) Port Female Branch Cross, Metric - DM80221

Size OD (mm)	BSPP Size	Part Number	Dimensions - mm (Inch)				Weight K kg (lbs)
			A	B	C Insertion Depth	D	
20	1/4"	DM80221K2004	63.50 (2.50)	20.02 (0.79)	37.08 (1.46)	44.45 (1.75)	0.45 (1.00)
20	3/8"	DM80221K2006	50.80 (2.20)	20.02 (0.79)	37.08 (1.46)	47.63 (1.88)	0.51 (1.12)
22	1/4"	DM80221K2204	63.50 (2.50)	20.02 (0.79)	38.10 (1.50)	44.45 (1.75)	0.45 (1.00)
22	3/8"	DM80221K2206	65.08 (2.56)	20.02 (0.79)	38.10 (1.50)	47.63 (1.88)	0.51 (1.12)
25	1/4"	DM80221K2504	63.50 (2.50)	20.02 (0.79)	41.91 (1.65)	44.45 (1.75)	0.54 (1.20)
25	3/8"	DM80221K2506	65.08 (2.56)	20.02 (0.79)	41.91 (1.65)	47.63 (1.88)	0.60 (1.32)
25	1/2"	DM80221K2508	66.68 (2.63)	23.01 (0.91)	41.91 (1.65)	53.98 (2.13)	0.72 (1.59)
28	1/4"	DM80221K2804	66.68 (2.63)	20.02 (0.79)	44.45 (1.75)	44.45 (1.75)	0.59 (1.29)
28	3/8"	DM80221K2806	68.25 (2.69)	21.08 (0.83)	44.45 (1.75)	47.63 (1.88)	0.61 (1.34)
28	1/2"	DM80221K2808	69.85 (2.75)	23.01 (0.91)	44.45 (1.75)	53.98 (2.13)	0.72 (1.59)
30	1/4"	DM80221K3004	71.44 (2.81)	21.44 (0.84)	46.99 (1.85)	47.63 (1.88)	0.77 (1.70)
30	3/8"	DM80221K3006	73.02 (2.88)	21.08 (0.83)	46.99 (1.85)	47.63 (1.88)	0.78 (1.73)
30	1/2"	DM80221K3008	74.63 (2.94)	23.01 (0.91)	46.99 (1.85)	53.98 (2.13)	0.90 (1.99)
35	1/4"	DM80221K3504	72.24 (2.84)	25.40 (1.00)	50.80 (2.00)	53.98 (2.13)	0.86 (1.89)
35	3/8"	DM80221K3506	73.81 (2.91)	24.61 (0.97)	50.80 (2.00)	53.98 (2.13)	0.87 (1.92)
35	1/2"	DM80221K3508	75.41 (2.97)	24.61 (0.97)	50.80 (2.00)	57.15 (2.25)	0.94 (2.07)
38	1/4"	DM80221K3804	80.98 (3.19)	26.19 (1.03)	54.61 (2.15)	57.15 (2.25)	1.31 (2.89)
38	3/8"	DM80221K3806	82.55 (3.25)	26.19 (1.03)	54.61 (2.15)	57.15 (2.25)	1.34 (2.96)
38	1/2"	DM80221K3808	84.15 (3.31)	27.79 (1.09)	54.61 (2.15)	63.50 (2.50)	1.49 (3.28)
42	3/8"	DM20221K2006	82.55 (3.25)	29.36 (1.16)	60.45 (2.38)	63.50 (2.50)	1.51 (3.33)
42	1/2"	DM20221K2008	84.15 (3.31)	28.58 (1.13)	60.45 (2.38)	63.50 (2.50)	1.54 (3.39)
60	3/8"	DM20221K3206	107.95 (4.25)	38.10 (1.50)	88.90 (3.50)	81.28 (3.20)	2.86 (6.30)
60	1/2"	DM20221K3208	139.47 (4.31)	38.10 (1.50)	88.90 (3.50)	81.28 (3.20)	2.92 (6.43)

**Note:** Only available in Stainless Steel.

# DM 80 Series - Metric Tube

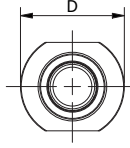
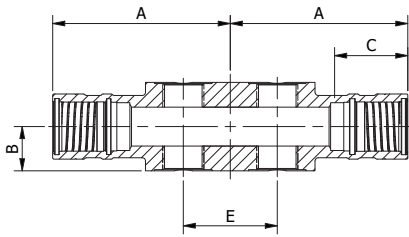

\*MATERIAL CODE:  
K = STAINLESS STEEL

ORDER EXAMPLE:  
DM80241K2004

## BSPP (4) Port Female Branch Cross, Metric - DM80241

Size OD (mm)	BSPP Size	Part Number	Dimensions - mm (Inch)					Weight K kg (lbs)
			A	B	C Insertion Depth	C	E	
20	1/4"	DM80241K2004	88.90 (3.50)	20.02 (0.79)	37.08 (1.46)	44.45 (1.75)	50.80 (2.00)	0.92 (2.02)
20	3/8"	DM80241K2006	92.08 (3.63)	20.02 (0.79)	37.08 (1.46)	47.63 (1.88)	53.97 (2.13)	1.13 (2.50)
22	1/4"	DM80241K2204	88.90 (3.50)	20.02 (0.79)	38.10 (1.50)	44.45 (1.75)	50.80 (2.00)	1.01 (2.24)
22	3/8"	DM80241K2206	92.08 (3.63)	20.02 (0.79)	38.10 (1.50)	47.63 (1.88)	53.97 (2.13)	1.06 (2.33)
25	1/4"	DM80241K2504	88.90 (3.50)	20.02 (0.79)	41.91 (1.65)	44.45 (1.75)	50.80 (2.00)	1.01 (2.24)
25	3/8"	DM80241K2506	92.08 (3.63)	20.02 (0.79)	41.91 (1.65)	47.63 (1.88)	53.97 (2.13)	1.15 (2.54)
25	1/2"	DM80241K2508	95.25 (3.75)	23.02 (0.91)	41.91 (1.65)	53.98 (2.13)	57.15 (2.25)	1.50 (3.30)
28	1/4"	DM80241K2804	92.08 (3.63)	20.02 (0.79)	44.45 (1.75)	44.45 (1.75)	50.80 (2.00)	1.04 (2.30)
28	3/8"	DM80241K2806	95.25 (3.75)	21.08 (0.83)	44.45 (1.75)	47.63 (1.88)	53.97 (2.13)	1.14 (2.51)
28	1/2"	DM80241K2808	98.43 (3.88)	23.01 (0.91)	44.45 (1.75)	53.98 (2.13)	57.15 (2.25)	1.46 (3.22)
30	1/4"	DM80241K3004	96.82 (3.81)	21.43 (0.84)	46.99 (1.85)	47.63 (1.88)	50.80 (2.00)	1.25 (2.75)
30	3/8"	DM80241K3006	100.02 (3.94)	21.08 (0.83)	46.99 (1.85)	47.63 (1.88)	53.97 (2.13)	1.28 (2.82)
30	1/2"	DM80241K3008	103.20 (4.06)	23.01 (0.91)	46.99 (1.85)	53.98 (2.13)	57.15 (2.25)	1.60 (3.52)
35	1/4"	DM80241K3504	97.64 (3.84)	25.40 (1.00)	50.80 (2.00)	53.98 (2.13)	50.80 (2.00)	1.48 (3.26)
35	3/8"	DM80241K3506	100.81 (3.97)	24.61 (0.97)	50.80 (2.00)	53.98 (2.13)	53.97 (2.13)	1.51 (3.34)
35	1/2"	DM80241K3508	103.99 (4.09)	24.61 (0.97)	50.80 (2.00)	57.15 (2.25)	57.15 (2.25)	1.69 (3.73)
38	1/4"	DM80241K3804	106.38 (4.19)	26.19 (1.03)	54.61 (2.15)	57.15 (2.25)	50.80 (2.00)	1.98 (4.37)
38	3/8"	DM80241K3806	109.55 (4.31)	26.19 (1.03)	54.61 (2.15)	57.15 (2.25)	53.97 (2.13)	2.06 (4.55)
38	1/2"	DM80241K3808	112.73 (4.44)	27.79 (1.09)	54.61 (2.15)	63.50 (2.50)	57.15 (2.25)	2.44 (5.38)
42	3/8"	DM20241K2006	109.55 (4.31)	29.36 (1.16)	60.45 (2.38)	63.50 (2.50)	53.97 (2.13)	2.39 (5.28)
42	1/2"	DM20241K2008	112.73 (4.44)	28.58 (1.13)	60.45 (2.38)	63.50 (2.50)	57.15 (2.25)	2.44 (5.37)
60	3/8"	DM20241K3206	134.95 (5.31)	38.10 (1.50)	88.90 (3.50)	81.28 (3.20)	53.97 (2.13)	4.21 (9.29)
60	1/2"	DM20241K3208	138.13 (5.44)	38.10 (1.50)	88.90 (3.50)	81.28 (3.20)	57.15 (2.25)	4.33 (9.55)































**Note:** Only available in Stainless Steel.

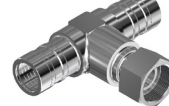

# Specialty Fitting Configuration Guide

## DM 80 Series - Metric Tube

6mm to 60mm

					
<b>JIC 37° 90° Elbow Male</b> DM80355	<b>JIC 37° Branch Tee Male</b> DM80177	<b>JIC 37° Run Tee Male</b> DM80178	<b>JIC 37° 90° Elbow Female Swivel</b> DM80354	<b>JIC 37° Branch Tee Female Swivel</b> DM80170	<b>NPT 90° Elbow Male</b> DM80057
					
<b>NPT Branch Tee Male</b> DM80176	<b>NPT Run Tee Male</b> DM80181	<b>NPT 90° Elbow Female</b> DM80061	<b>ORFS 90° Elbow Male</b> DM80011	<b>ORFS Branch Tee Male</b> DM80013	<b>ORFS Run Tee Male</b> DM80014
					
<b>ORFS 90° Elbow Female Swivel</b> DM80021	<b>ORFS Branch Tee Female Swivel</b> DM80023	<b>SAE 90° Elbow Male</b> DM80105	<b>SAE Branch Tee Male</b> DM80174	<b>SAE Run Tee Male</b> DM80179	<b>SAE 90° Elbow Female</b> DM80387
					
<b>BSPP 90° Elbow Male</b> DM80168	<b>BSPP Branch Tee Male</b> DM80175	<b>BSPP Run Tee Male</b> DM80180	<b>BSPP 90° Elbow Female</b> DM80169	<b>DIN 24° 90° Elbow Male</b> DM80073	<b>DIN 24° Branch Tee Male</b> DM80182
					
<b>DIN 24° Run Tee Male</b> DM80183	<b>DIN 24° 90° Elbow Female Swivel</b> DM80069	<b>DIN 24° Branch Tee Female Swivel</b> DM80184	<b>Compact Elbow x Code 61 Flange</b> DM80231	<b>Compact Elbow x Code 62 Flange</b> DM80232	<b>90° PYPLOK® x SAE Code 61 Flange</b> DM80391

# Specialty Fitting Configuration Guide

## DM 80 Series - Metric Tube

6mm to 60mm



**90° PYLOK® x  
SAE Code 62  
Flange**  
DM80392



**NPS to Metric  
Tube Reducer**  
DM20801



**Extra Long  
Coupling**  
DM80301

Introduction

Technical  
Information

DM 20 –  
NPS Pipe

DM 60 –  
OD Tube

DM 80 –  
Metric Tube

DM Series  
Thread Adapter

DM 80 – Metric  
& JIS Tube

DP 40N – NPS  
Low Pressure

DP40M – Metric  
Low Pressure

PYPLOK®  
Tooling

Installation  
Procedures

Appendix



# General Characteristics

## DM Series - Threaded Adapters

Fitting Material Specifications	Material Specification
K = Stainless Steel	ASTM-A479/A182-316
G = Carbon Steel	ASTM-A105/A350 LF2
B = Copper Nickel 70/30	MIL-C71500

O-Ring Material Specifications	O-Ring Temperature Limits
VITON (Brown Colour)	-15°F to 400°F (-26°C to 205°C)
EPDM (Black Colour)	-60°F to 400°F (-51°C to 205°C)

For seal compatibility and selection for each system consult factory. Other seal materials for specific applications of compatibility and temperature are available upon request.

### Ordering Information

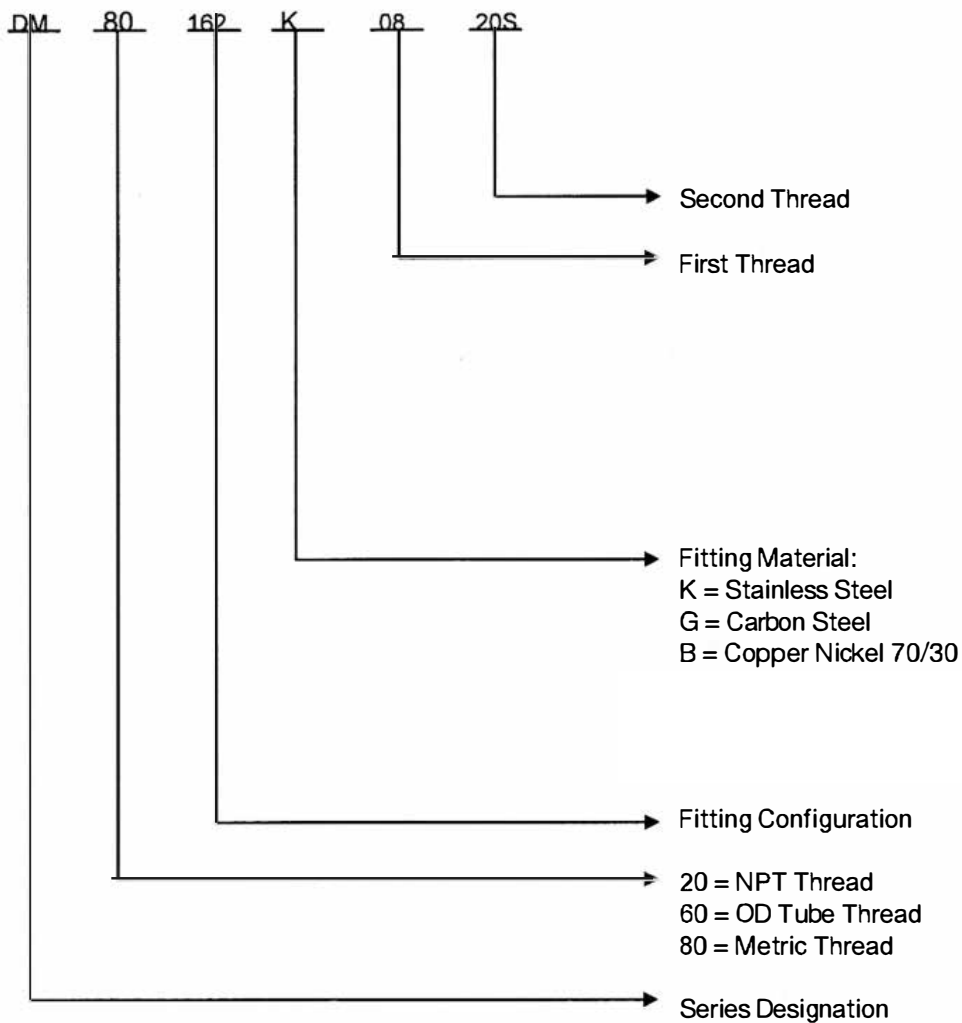

System design and safe application is the responsibility of the end-user. Consideration must be taken to confirm proper fitting selection is made to ensure proper compatibility, function and operation of the fitting within the piping system. The technical and performance information such as weights, dimensions and ratings in this catalogue supersede all previous published data. Tube-Mac® reserves the right to change technical data and product dimension, ratings and other aspects without notice.

3D step models available upon request



# Standard Fitting Configuration Guide

## DM Series - Threaded Adapters

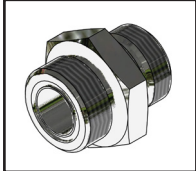

**BSPP Male to ORFS Male Adapter**  
DM80160  
Page F3

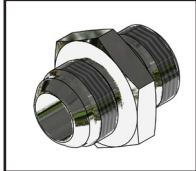

**BSPP Male to JIC Male Adapter**  
DM80161  
Page F4

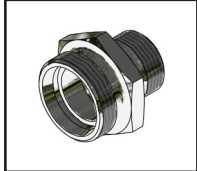

**BSPP Male to DIN Male Adapter**  
DM80162  
Page F5

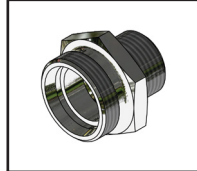

**SAE Male to DIN Male Adapter**  
DM80163  
Page F6

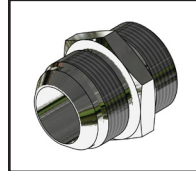

**SAE Male to JIC Male Adapter**  
DM80164  
Page F7

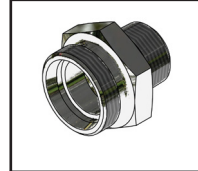

**NPT Male to DIN Male Adapter**  
DM20165  
Page F8

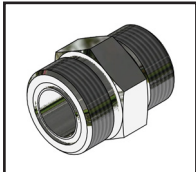

**SAE Male to ORFS Male Adapter**  
DM60166  
Page F9



**BSPP Male to DIN Female Adapter**  
DM80167  
Page F10

# DM Series - Threaded Adapters

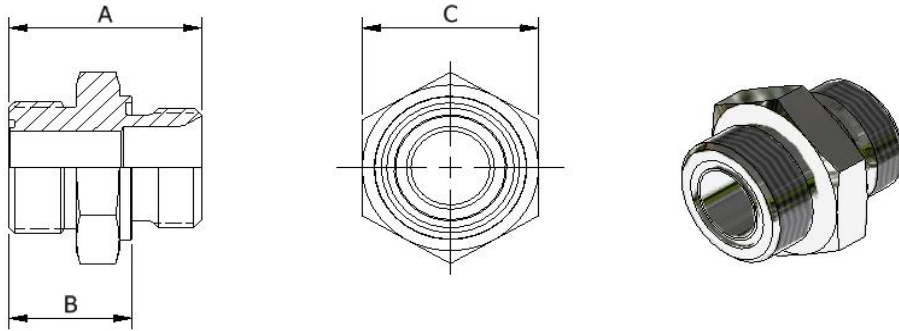

## BSPP Male to ORFS Male Adapter - DM80160

BSPP Size	ORFS Size	Part Number	Dimensions - mm (Inch)			*Weight K & G kg (lbs)
			A	B	C	
1/2"	1/2"	DM80160*08	39.0 (1.54)	24.9 (0.98)	30.0 (1.18)	0.10 (0.22)
3/4"	3/4"	DM80160*12	49.0 (1.93)	32.9 (1.30)	36.0 (1.42)	0.16 (0.36)
1"	1"	DM80160*16	50.0 (1.97)	31.9 (1.26)	46.0 (1.81)	0.29 (0.65)
1-1/4"	1-1/4"	DM80160*20	55.0 (2.17)	34.9 (1.37)	50.0 (1.97)	0.41 (0.91)
1-1/2"	1-1/2"	DM80160*24	60.0 (2.36)	37.9 (1.49)	55.0 (2.17)	0.55 (1.20)

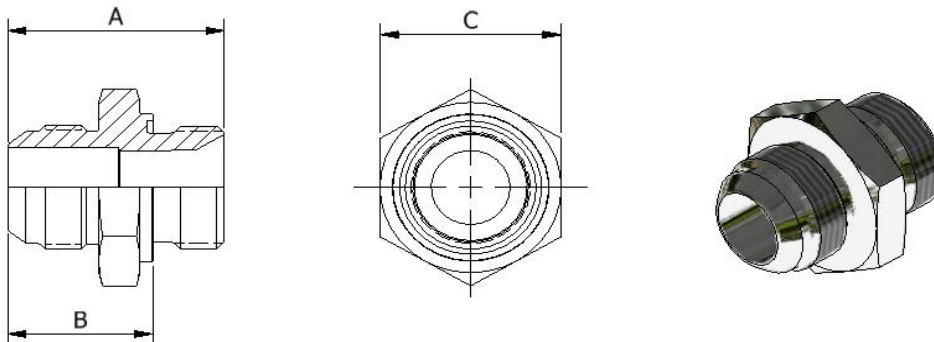

## BSPP Male to JIC Male Adapter - DM80161

BSPP Size	JIC Size	Part Number	Dimensions - mm (Inch)			*Weight K & G kg (lbs)
			A	B	C	
1/2"	1/2"	DM80161*08	42.0 (1.65)	27.9 (1.10)	30.0 (1.18)	0.10 (0.22)
3/4"	3/4"	DM80161*12	51.0 (2.01)	34.9 (1.38)	36.0 (1.42)	0.17 (0.37)
1"	1"	DM80161*16	55.0 (2.17)	36.9 (1.45)	46.0 (1.81)	0.28 (0.61)
1-1/4"	1-1/4"	DM80161*20	61.0 (2.40)	41.0 (1.61)	50.0 (1.97)	0.40 (0.89)
1-1/2"	1-1/2"	DM80161*24	67.0 (2.64)	44.9 (1.77)	55.0 (2.17)	0.54 (1.18)

3D step models available upon request

# DM Series - Threaded Adapters

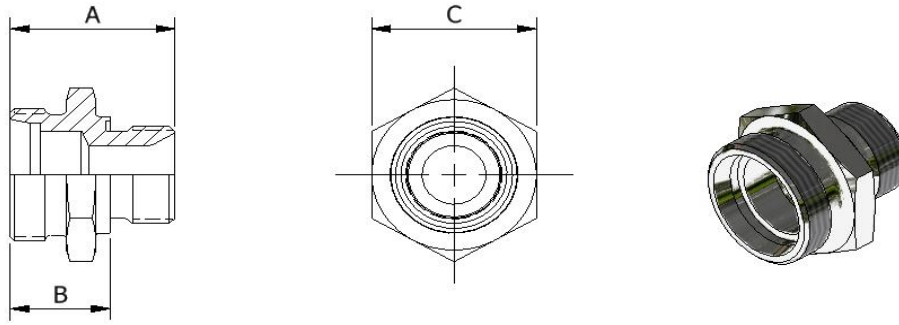

## BSPP Male to DIN Male Adapter - DM80162

BSPP Size	DIN 2353/ISO 8434-1L&S Series Thread	Part Number	Dimensions - mm (Inch)			*Weight K & G kg (lbs)
			A	B	C	
1/4"	10S - M18x1.5	DM80162*0410S	34.0 (1.34)	22.1 (0.87)	22.0 (0.87)	0.05 (0.12)
1/4"	12L - M18x1.5	DM80162*0412L	31.0 (1.22)	19.1 (0.75)	24.0 (0.95)	0.05 (0.10)
1/4"	12S - M20x1.5	DM80162*0412S	36.0 (1.42)	24.1 (0.95)	24.0 (0.95)	0.07 (0.10)
3/8"	16S - M24x1.5	DM80162*0616S	39.0 (1.54)	27.1 (1.07)	30.0 (1.18)	0.11 (0.24)
3/8"	18L - M26x1.5	DM80162*0618L	36.0 (1.42)	24.0 (0.95)	32.0 (1.26)	0.13 (0.28)
1/2"	20S - M30x2.0	DM80162*0820S	45.0 (1.77)	30.9 (1.22)	36.0 (1.42)	0.17 (0.38)
1/2"	22L - M30x2.0	DM80162*0822L	38.0 (1.50)	23.9 (0.94)	36.0 (1.42)	0.12 (0.26)
3/4"	25S - M36x2.0	DM80162*1225S	51.0 (2.01)	34.9 (1.37)	46.0 (1.81)	0.29 (0.64)
3/4"	28L - M36x2.0	DM80162*1228L	41.0 (1.61)	24.9 (0.98)	41.0 (1.61)	0.16 (0.35)
1"	30S - M42x2.0	DM80162*1630S	55.0 (2.17)	36.9 (1.45)	50.0 (1.97)	0.38 (0.83)
1"	35L - M45x2.0	DM80162*1635L	46.0 (1.81)	27.9 (1.10)	50.0 (1.97)	0.27 (0.59)
1-1/4"	38S - M52x2.0	DM80162*2038S	62.0 (2.44)	41.9 (1.65)	60.0 (2.36)	0.64 (1.40)
1-1/4"	42L - M52x2.0	DM80162*2042L	50.0 (1.97)	29.9 (1.18)	60.0 (2.36)	0.43 (0.94)

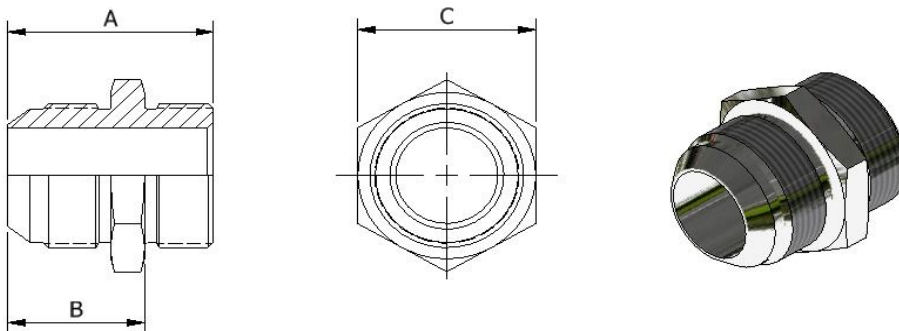

## BSPP Male to JIC Male Adapter - DM80164

SAE Size	JIC Size	Part Number	Dimensions - mm (Inch)			*Weight K & G Kg (Lbs)"
			A	B	C	
1/2"	1/2"	DM60164*08	38.0 (1.50)	24.0 (0.95)	22.2 (0.88)	0.06 (0.14)
3/4"	3/4"	DM60164*12	50.0 (1.97)	31.5 (1.24)	31.8 (1.25)	0.15 (0.34)
1"	1"	DM60164*16	52.0 (2.05)	33.5 (1.32)	38.1 (1.50)	0.15 (0.34)
1-1/4"	1-1/4"	DM60164*20	55.0 (2.17)	36.5 (1.44)	47.6 (1.88)	0.34 (0.74)
1-1/2"	1-1/2"	DM60164*24	60.0 (2.36)	41.5 (1.63)	54.0 (2.13)	0.47 (1.03)

3D step models available upon request

# DM Series - Threaded Adapters

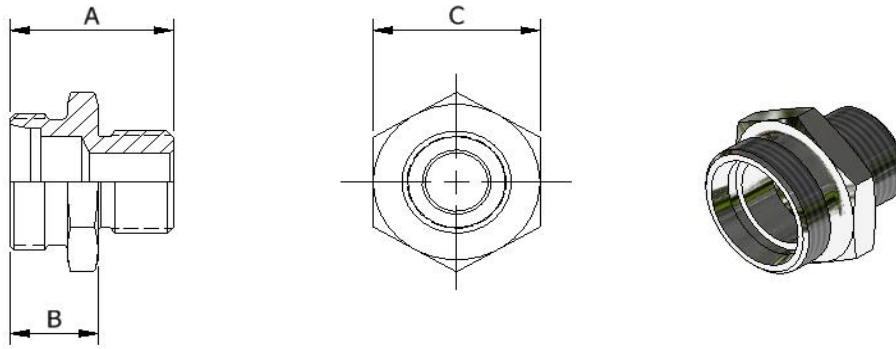

## SAE Male to DIN Male Adapter - DM60163

SAE Size	DIN 2353/ISO 8434-1L & S Series Thread	Part Number	Dimensions - mm (Inch)			"Weight K & G Kg (Lbs)"
			A	B	C	
1/2"	20S - M30x2.0	DM60163*0820S	42.0 (1.65)	28.0 (1.10)	36.0 (1.42)	0.16 (0.36)
1/2"	22L - M30x2.0	DM60163*0822L	38.0 (1.50)	24.0 (0.95)	36.0 (1.42)	0.13 (0.29)
3/4"	25S - M36x2.0	DM60163*1225S	50.0 (1.97)	31.5 (1.24)	46.0 (1.81)	0.29 (0.65)
3/4"	28L - M36x2.0	DM60163*1228L	40.0 (1.58)	21.5 (0.85)	41.0 (1.61)	0.16 (0.36)
1"	30S - M42x2.0	DM60163*1630S	52.0 (2.05)	33.5 (1.32)	50.0 (1.97)	0.36 (0.80)
1"	35L - M45x2.0	DM60163*1635L	43.0 (1.69)	24.5 (0.97)	50.0 (1.97)	0.25 (0.56)
1-1/4"	38S - M52x2.0	DM60163*2038S	57.0 (2.24)	38.5 (1.52)	60.0 (2.36)	0.59 (1.30)
1-1/4"	42L - M52x2.0	DM60163*2042L	45.0 (1.77)	26.5 (1.04)	60.0 (2.36)	0.39 (0.85)

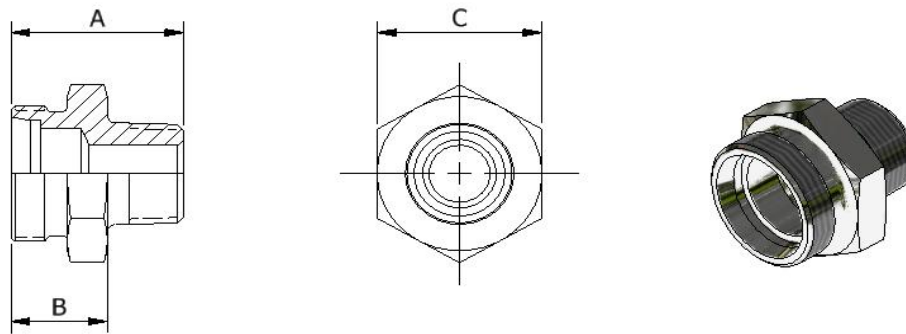

## NPT Male to DIN Male Adapter - DM20165

SAE Size	DIN 2353/ISO 8434-1L & S Series Thread	Part Number	Dimensions - mm (Inch)			"Weight K & G Kg (Lbs)"
			A	B	C	
1/2"	20S - M30x2.0	DM20165*0820S	48.0 (1.89)	29.0 (1.14)	36.0 (1.42)	0.19 (0.41)
1/2"	22L - M30x2.0	DM20165*0822L	43.0 (1.69)	23.9 (0.94)	36.0 (1.42)	0.15 (0.32)
3/4"	25S - M36x2.0	DM20165*1225S	52.0 (2.05)	32.9 (1.30)	46.0 (1.81)	0.31 (0.70)
3/4"	28L - M36x2.0	DM20165*1228L	43.0 (1.69)	23.9 (0.94)	41.0 (1.61)	0.19 (0.42)
1"	30S - M42x2.0	DM20165*1630S	59.0 (2.32)	35.1 (1.38)	50.0 (1.97)	0.42 (0.92)
1"	35L - M45x2.0	DM20165*1635L	50.0 (1.97)	26.1 (0.97)	50.0 (1.97)	0.31 (0.70)
1-1/4"	38S - M52x2.0	DM20165*2038S	57.0 (2.24)	32.0 (1.26)	60.0 (2.36)	0.51 (1.12)
1-1/4"	42L - M52x2.0	DM20165*2042L	51.0 (2.009)	26.0 (1.03)	60.0 (2.36)	0.42 (0.92)

3D step models available upon request

# DM Series - Threaded Adapters

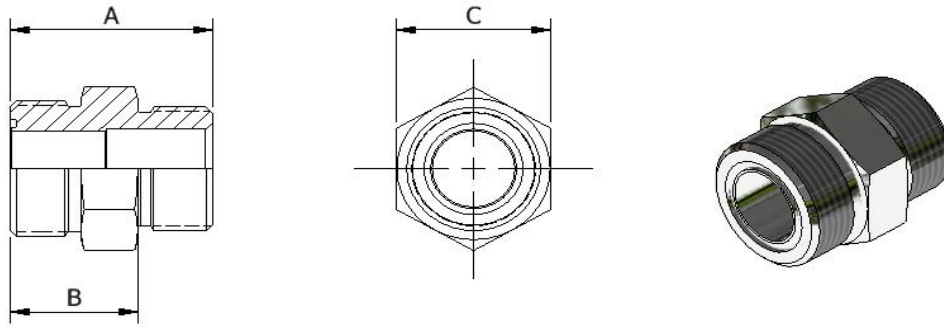

## SAE Male to ORFS Male Adapter - DM60166

SAE Size	ORFS Size	Part Number	Dimensions - mm (Inch)			"Weight K & G Kg (Lbs)"
			A	B	C	
1/2"	1/2"	DM60166*08	36.0 (1.42)	22.0 (0.87)	22.2 (0.88)	0.07 (0.16)
3/4"	3/4"	DM60166*12	49.0 (1.93)	30.5 (1.20)	31.8 (1.25)	0.19 (0.42)
1"	1"	DM60166*16	50.0 (1.97)	31.6 (1.24)	38.1 (1.50)	0.26 (0.58)
1-1/4"	1-1/4"	DM60166*20	52.0 (2.05)	33.5 (1.32)	47.6 (1.88)	0.40 (0.89)
1-1/2"	1-1/2"	DM60166*24	54.0 (2.13)	35.5 (1.40)	54.0 (2.13)	0.53 (1.16)

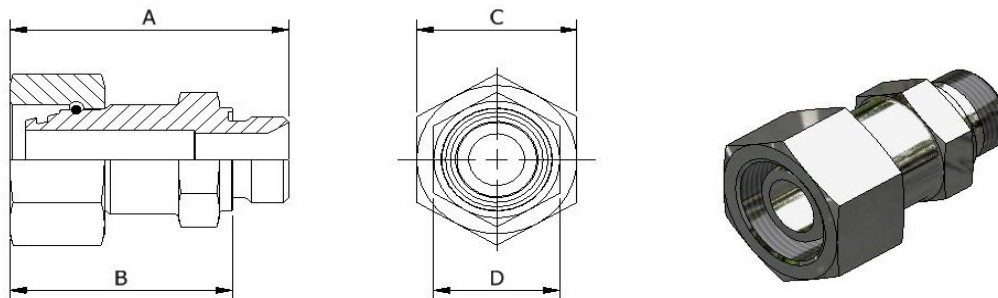

## BSPP Male to DIN Female Swivel Adapter - DM80167

BSPP Size	DIN 2353/ISO 8434-1L & S Series Thread	Part Number	Dimensions - mm (Inch)				"Weight K & G Kg (Lbs)"
			A	B	C	D	
1/4"	10S - M18x1.5	DM80167*0410S	43.5 (1.71)	31.7 (1.25)	22.0 (0.87)	19.0 (0.75)	0.08 (0.17)
1/4"	12L - M18x1.5	DM80167*0412L	43.5 (1.71)	31.7 (1.25)	22.0 (0.87)	19.0 (0.75)	0.08 (0.17)
1/4"	12S - M20x1.5	DM80167*0412S	45.5 (1.79)	33.6 (1.32)	24.0 (0.94)	19.0 (0.75)	0.09 (0.20)
3/8"	16S - M24x1.5	DM80167*0616S	50.0 (1.97)	38.1 (1.50)	30.0 (1.18)	22.0 (0.87)	0.15 (0.32)
3/8"	18L - M26x1.5	DM80167*0618L	52.0 (2.05)	40.0 (1.58)	32.0 (1.26)	30.0 (1.18)	0.18 (0.41)
1/2"	20S - M30x2.0	DM80167*0820S	60.0 (2.36)	45.9 (1.81)	36.0 (1.42)	30.0 (1.18)	0.25 (0.55)
1/2"	22L - M30x2.0	DM80167*0822L	61.0 (2.40)	46.9 (1.85)	36.0 (1.42)	30.0 (1.18)	0.24 (0.54)
3/4"	25S - M36x2.0	DM80167*1225S	72.0 (2.83)	55.9 (2.20)	46.0 (1.81)	36.0 (1.42)	0.47 (1.04)
3/4"	28L - M36x2.0	DM80167*1228L	64.0 (2.52)	47.9 (1.88)	41.0 (1.61)	36.0 (1.42)	0.31 (0.68)
1"	30S - M42x2.0	DM80167*1630S	81.0 (3.19)	62.8 (2.47)	50.0 (1.97)	46.0 (1.81)	0.65 (1.43)
1"	35L - M45x2.0	DM80167*1635L	82.0 (3.23)	63.9 (2.52)	50.0 (1.97)	46.0 (1.81)	0.59 (1.31)
1-1/4"	38S - M52x2.0	DM80167*2038S	93.0 (3.66)	72.9 (2.87)	60.0 (2.36)	50.0 (1.97)	1.05 (2.31)
1-1/4"	42L - M52x2.0	DM80167*2042L	85.0 (3.35)	64.9 (2.56)	60.0 (2.36)	50.0 (1.97)	0.82 (1.80)





# General Characteristics

## DM 80 Series - JIS Metric Tube

### Fitting Material Specifications      Material Specification

K = Stainless Steel	ASTM-A479/A182-316
G = Carbon Steel	ASTM-A105/A350 LF2
B = Copper Nickel 70/30	MIL-C71500
C = Copper Nickel 90/10	MIL-C70600
D = Duplex	ASTM-A479/A182-UNS31803
Z = Super Duplex	ASTM-A479/A182-UNS32750

### O-Ring Material Specifications      O-Ring Temperature Limits

VITON (Brown Colour)	-15°F to 400°F (-26°C to 205°C)
EPDM (Black Colour)	-60°F to 400°F (-51°C to 205°C)

For seal compatibility and selection for each system consult factory. Other seal materials for specific applications of compatibility and temperature are available upon request.

### Ordering Information

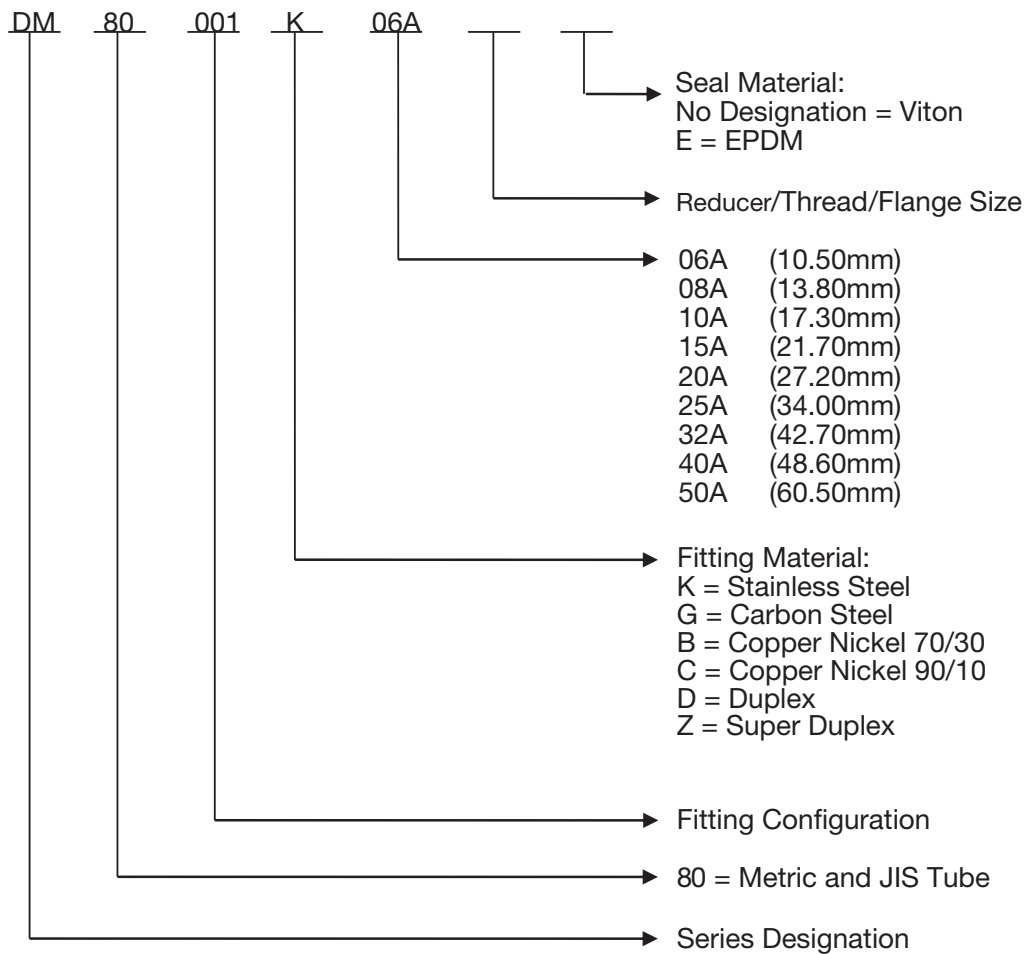

System design and safe application is the responsibility of the end-user. Consideration must be taken to confirm proper fitting selection is made to ensure proper compatibility, function and operation of the fitting within the piping system. The technical and performance information such as weights, dimensions and ratings in this catalogue supersede all previous published data. Tube-Mac® reserves the right to change technical data and product dimension, ratings and other aspects without notice.



# Standard Fitting Configuration Guide

## DM 80 Series - JIS Metric Tube

06A to 50A

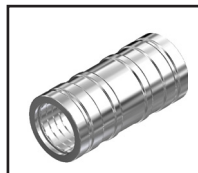

**Coupling**  
DM80001  
Page E27



**Coupling with  
Inner Stop**  
DM80002  
Page E27



**90° Elbow**  
DM80003  
Page E28



**45° Elbow**  
DM80017  
Page E28



**Tee**  
DM80004  
Page E29



**End Cap**  
DM80085  
Page E29

# DM 80 Series - JIS Metric Tube

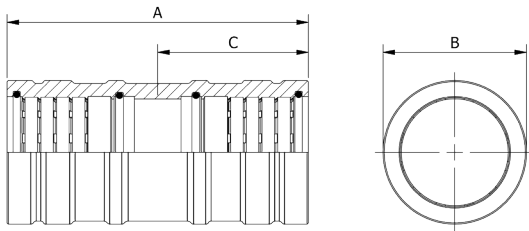

**\*MATERIAL CODE:**  
**K = STAINLESS STEEL**  
**G = CARBON STEEL**  
**B = COPPER NICKEL 70/30**

**ORDER EXAMPLE:**  
**DM80001G06A**

## Coupling, Metric, JIS - DM80001

JIS Size	Part Number	Dimensions - mm (Inch)			*Weight K & G kg (lbs)
		A	B	C Insertion Depth	
06A	DM80001*06A	48.30 (1.90)	15.09 (0.59)	24.13 (0.95)	0.03 (0.06)
08A	DM80001*08A	54.00 (2.13)	18.59 (0.73)	27.00 (1.06)	0.05 (0.10)
10A	DM80001*10A	64.01 (2.52)	23.70 (0.93)	32.00 (1.26)	0.09 (0.19)
15A	DM80001*15A	74.17 (2.91)	28.70 (1.13)	37.08 (1.46)	0.15 (0.32)
20A	DM80001*20A	84.07 (3.31)	35.31 (1.39)	41.91 (1.65)	0.24 (0.53)
25A	DM80001*25A	93.98 (3.70)	41.91 (1.65)	46.99 (1.85)	0.39 (0.85)
32A	DM80001*32A	120.65 (4.75)	57.40 (2.26)	60.45 (2.38)	0.89 (1.96)
40A	DM80001*40A	127.00 (5.00)	65.53 (2.58)	63.50 (2.50)	1.26 (2.78)
50A	DM80001*50A	177.80 (7.00)	77.22 (3.04)	88.90 (3.50)	2.00 (4.40)

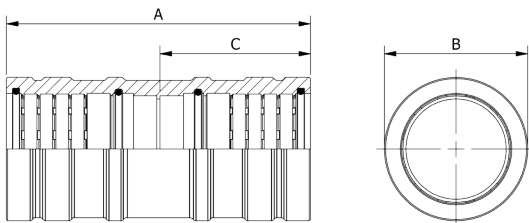

**\*MATERIAL CODE:**  
**K = STAINLESS STEEL**  
**G = CARBON STEEL**  
**B = COPPER NICKEL 70/30**

**ORDER EXAMPLE:**  
**DM80002G06A**

## Coupling with Inner Stop, Metric, JIS - DM80002

JIS Size	Part Number	Dimensions - mm (Inch)			*Weight K & G kg (lbs)
		A	B	C Insertion Depth	
06A	DM80002*06A	49.53 (1.95)	15.09 (0.59)	24.13 (0.95)	0.06 (0.03)
08A	DM80002*08A	55.37 (2.18)	18.59 (0.73)	26.92 (1.06)	0.05 (0.10)
10A	DM80002*10A	65.28 (2.57)	23.70 (0.93)	32.00 (1.26)	0.09 (0.20)
15A	DM80002*15A	75.44 (2.97)	28.70 (1.13)	37.08 (1.46)	0.15 (0.32)
20A	DM80002*20A	85.34 (3.36)	35.31 (1.39)	41.91 (1.65)	0.24 (0.54)
25A	DM80002*25A	95.25 (3.75)	41.91 (1.65)	46.99 (1.85)	0.39 (0.85)
32A	DM80002*32A	121.92 (4.80)	57.40 (2.26)	60.45 (2.38)	0.89 (1.96)
40A	DM80002*40A	128.27 (5.05)	65.53 (2.58)	63.50 (2.50)	1.26 (2.78)
50A	DM80002*50A	179.07 (7.05)	77.22 (3.04)	88.90 (3.50)	2.00 (4.40)

3D step models available upon request

# DM 80 Series - JIS Metric Tube

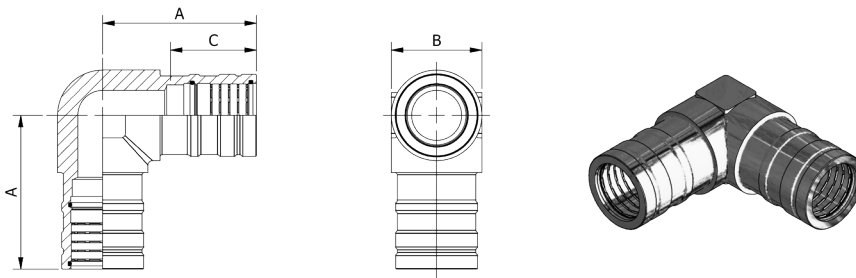

**\*MATERIAL CODE:**  
 K = STAINLESS STEEL  
 G = CARBON STEEL  
 B = COPPER NICKEL 70/30

**ORDER EXAMPLE:**  
 DM80003G06A

## 90° Elbow, Metric, JIS - DM80003

JIS Size	Part Number	Dimensions - mm (Inch)			*Weight K & G kg (lbs)
		A	B	C Insertion Depth	
06A	DM80003*06A	42.67 (1.68)	21.84 (0.86)	24.13 (0.95)	0.08 (0.18)
08A	DM80003*08A	45.29 (1.78)	21.84 (0.86)	26.92 (1.06)	0.09 (0.20)
10A	DM80003*10A	52.07 (2.05)	26.92 (1.06)	32.00 (1.26)	0.20 (0.43)
15A	DM80003*15A	73.15 (2.88)	33.02 (1.30)	37.08 (1.46)	0.36 (0.80)
20A	DM80003*20A	76.96 (3.03)	40.13 (1.58)	41.91 (1.65)	0.58 (1.27)
25A	DM80003*25A	85.60 (3.37)	50.04 (1.97)	46.99 (1.85)	1.13 (2.50)
32A	DM80003*32A	107.95 (4.25)	63.50 (2.50)	60.45 (2.38)	2.70 (5.95)
40A	DM80003*40A	115.32 (4.54)	71.37 (2.81)	63.50 (2.50)	3.22 (7.10)
50A	DM80003*50A	138.43 (5.45)	82.55 (3.25)	88.90 (3.50)	4.40 (9.70)

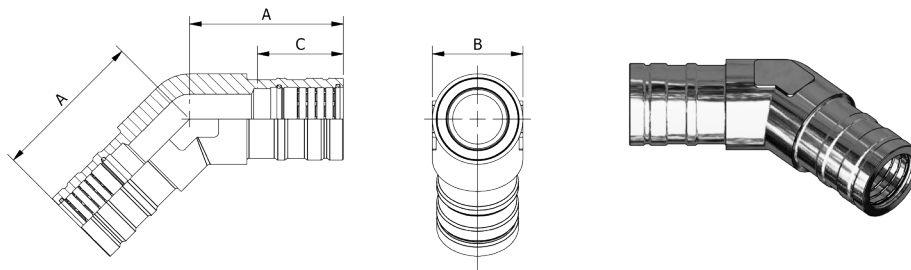

**\*MATERIAL CODE:**  
 K = STAINLESS STEEL  
 G = CARBON STEEL  
 B = COPPER NICKEL 70/30

**ORDER EXAMPLE:**  
 DM80017G06A

## 45° Elbow, Metric, JIS - DM80017

JIS Size	Part Number	Dimensions - mm (Inch)			*Weight K & G kg (lbs)
		A	B	C Insertion Depth	
06A	DM80017*06A	42.67 (1.68)	21.84 (0.86)	24.13 (0.95)	0.09 (0.19)
08A	DM80017*08A	45.21 (1.78)	21.84 (0.86)	26.92 (1.06)	0.13 (0.29)
10A	DM80017*10A	52.07 (2.05)	26.92 (1.06)	32.00 (1.26)	0.23 (0.50)
15A	DM80017*15A	73.15 (2.88)	33.02 (1.30)	37.08 (1.46)	0.46 (1.02)
20A	DM80017*20A	76.96 (3.03)	40.13 (1.58)	41.91 (1.65)	0.72 (1.59)
25A	DM80017*25A	85.60 (3.37)	50.04 (1.97)	46.99 (1.85)	1.22 (2.68)
32A	DM80017*32A	107.95 (4.25)	63.50 (2.50)	60.45 (2.38)	2.54 (5.60)
40A	DM80017*40A	115.32 (4.54)	71.37 (2.81)	63.50 (2.50)	3.36 (7.40)
50A	DM80017*50A	138.43 (5.45)	82.55 (3.25)	88.90 (3.50)	4.35 (9.60)

# DM 80 Series - JIS Metric Tube

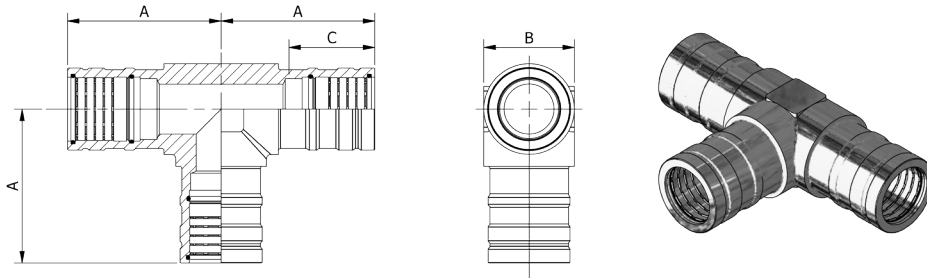

**\*MATERIAL CODE:**  
 K = STAINLESS STEEL  
 G = CARBON STEEL  
 B = COPPER NICKEL 70/30

**ORDER EXAMPLE:**  
 DM80004G06A

## Tee, Metric, JIS - DM80004

JIS Size	Part Number	Dimensions - mm (Inch)			*Weight K & G kg (lbs)
		A	B	C Insertion Depth	
06A	DM80004*06A	42.67 (1.68)	21.84 (0.86)	24.13 (0.95)	0.09 (0.20)
08A	DM80004*08A	45.21 (1.78)	21.84 (0.86)	26.92 (1.06)	0.15 (0.34)
10A	DM80004*10A	52.07 (2.05)	26.92 (1.06)	32.00 (1.26)	0.29 (0.65)
15A	DM80004*15A	73.15 (2.88)	33.02 (1.30)	37.08 (1.46)	0.59 (1.30)
20A	DM80004*20A	76.96 (3.03)	40.13 (1.58)	41.91 (1.65)	0.91 (2.01)
25A	DM80004*25A	85.60 (3.37)	50.04 (1.97)	46.99 (1.85)	1.46 (3.22)
32A	DM80004*32A	107.95 (4.25)	63.50 (2.50)	60.45 (2.38)	3.22 (7.10)
40A	DM80004*40A	115.32 (4.54)	71.37 (2.81)	63.50 (2.50)	4.17 (9.20)
50A	DM80004*50A	138.43 (5.45)	82.55 (3.25)	88.90 (3.50)	5.55 (12.20)

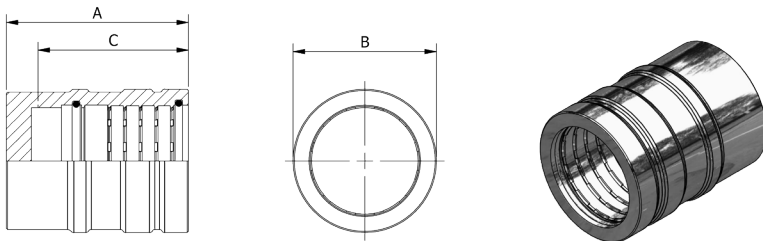

**\*MATERIAL CODE:**  
 K = STAINLESS STEEL  
 G = CARBON STEEL  
 B = COPPER NICKEL 70/30

**ORDER EXAMPLE:**  
 DM80085G06A

## End Cap, Metric, JIS - DM80085









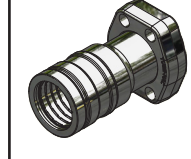
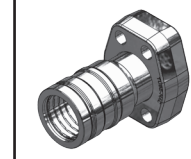
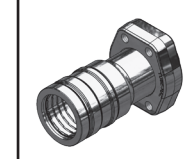
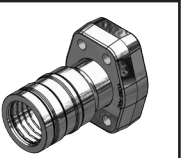

JIS Size	Part Number	Dimensions - mm (Inch)			*Weight K & G kg (lbs)
		A	B	C Insertion Depth	
06A	DM80085*06A	33.78 (1.33)	15.09 (0.59)	24.13 (0.95)	0.02 (0.05)
08A	DM80085*08A	37.59 (1.48)	18.59 (0.73)	26.92 (1.06)	0.04 (0.08)
10A	DM80085*10A	45.72 (1.80)	23.70 (0.93)	32.00 (1.26)	0.08 (0.17)
15A	DM80085*15A	55.63 (2.19)	28.70 (1.13)	37.08 (1.46)	0.14 (0.31)
20A	DM80085*20A	60.71 (2.39)	35.31 (1.39)	41.91 (1.65)	0.23 (0.50)
25A	DM80085*25A	65.53 (2.58)	41.91 (1.65)	46.99 (1.85)	0.34 (0.76)
32A	DM80085*32A	73.15 (2.88)	57.40 (2.26)	60.45 (2.38)	0.65 (1.44)
40A	DM80085*40A	76.20 (3.00)	65.53 (2.58)	63.50 (2.50)	0.90 (1.20)
50A	DM80085*50A	104.90 (4.13)	77.22 (3.04)	88.90 (3.50)	1.42 (3.13)

3D step models available upon request

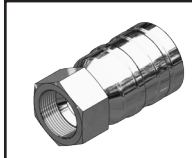
# Specialty Fitting Configuration Guide

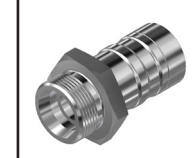
## DM 80 Series - JIS Metric Tube

06A to 50A

					
<b>Reducer</b> DM80101	<b>SAE Flange Body</b> DM80090	<b>Reducing Tee</b> DM80104	<b>ISO 6162-1 Flange</b> DM80091	<b>ISO 6162-2 Flange</b> DM80092	<b>ISO 6162-1 Tapped Flange</b> DM80095
					
<b>ISO 6162-2 Tapped Flange</b> DM80096	<b>JIC 37° Male</b> DM80055	<b>JIC 37° Female Swivel</b> DM80054	<b>BSPP Male</b> DM80153	<b>BSPP Female</b> DM80086	<b>DIN 24° Male</b> DM80066
					
<b>DIN 24° Female Swivel</b> DM80068	<b>Weldable Bulkhead</b> DM80089	<b>BSPP Female Branch Tee</b> DM80172			





# General Characteristics

## DP 40N Series – NPS Low Pressure

### Fitting Material Specifications

K = Stainless Steel  
 G = Carbon Steel  
 B = Copper Nickel 70/30  
 C = Copper Nickel 90/10  
 D = Duplex  
 Z = Super Duplex  
 T = Titanium

### Material Specification

ASTM-A479/A182-316  
 ASTM-A105/A350 LF2  
 MIL-C71500  
 MIL-C70600  
 ASTM-A479/A182-UNS31803  
 ASTM-A479/A182-UNS32750  
 ASTM B348 Gr.2

PYPLOK® DP 40 Series shapes such as Tees, Elbows and ANSI Flanged End are made as welded assemblies using ASME B16.9 SCH.40 Butt Weld Fitting with the following material specification:

K = Stainless Steel  
 G = Carbon Steel

ASTM-A312  
 ASTM-A105

### O-Ring Material Specifications

VITON (Brown Colour)  
 EPDM (Black Colour)

### O-Ring Temperature Limits

-15°F to 400°F (-26°C to 205°C)  
 -60°F to 400°F (-51°C to 205°C)

For seal compatibility and selection for each system consult factory. Other seal materials for specific applications of compatibility and temperature are available upon request.

### Ordering Information

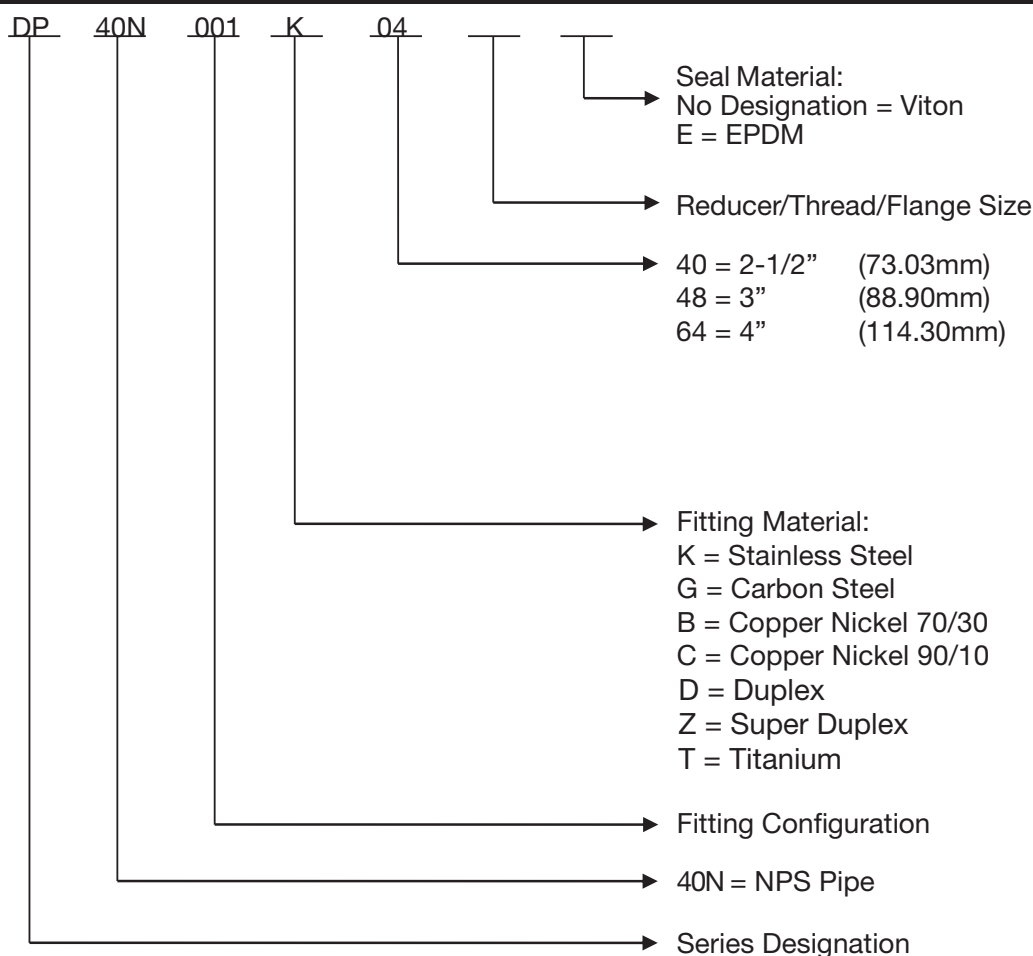

System design and safe application is the responsibility of the end-user. Consideration must be taken to confirm proper fitting selection is made to ensure proper compatibility, function and operation of the fitting within the piping system. The technical and performance information such as weights, dimensions and ratings in this catalogue supersede all previous published data. Tube-Mac® reserves the right to change technical data and product dimension, ratings and other aspects without notice.



# Standard Fitting Configuration Guide

## DP 40N Series - NPS Low Pressure

2-1/2" to 4"



**Low Pressure Coupling**  
DP40N100  
Page F3



**Low Pressure 90° Elbow**  
DP40N300  
Page F3

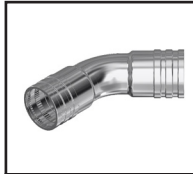

**Low Pressure 45° Elbow**  
DP40N017  
Page F4

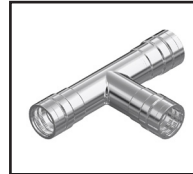

**Low Pressure Tee**  
DP40N400  
Page F4

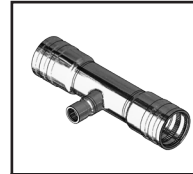

**Low Pressure Reducing Tee**  
DP40N104  
Page F5



**Low Pressure Reducer**  
DP40N101  
Page F5



**Low Pressure End Cap**  
DP40N085  
Page F6



**Low Pressure Flange - 150#**  
DP40N018  
Page F6



**Low Pressure SAE Code 61 Flange**  
DP40N091  
Page F7



**Low Pressure SAE Code 61 Tapped Flange**  
DP40N095  
Page F7

# DP 40N Series – NPS Low Pressure

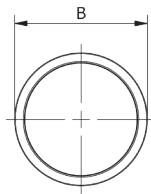
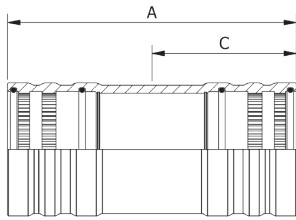

**\*MATERIAL CODE:**  
 K = STAINLESS STEEL  
 G = CARBON STEEL  
 B = COPPER NICKEL 70/30

**ORDER EXAMPLE:**  
 DP40N100G40

## Low Pressure Coupling, NPS - DP40N100

Size NPS	Part Number	Dimensions - Inch (mm)			*Weight K & G lbs (kg)
		A	B	C Insertion Depth	
2-1/2"	DP40N100*40	7.50 (190.50)	3.45 (87.63)	3.75 (95.25)	4.38 (1.99)
3"	DP40N100*48	8.70 (220.98)	4.14 (105.16)	4.35 (110.49)	6.68 (3.03)
4"	DP40N100*64	13.50 (342.90)	5.32 (135.13)	6.75 (171.45)	18.63 (8.45)

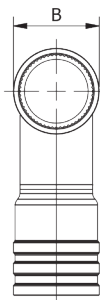
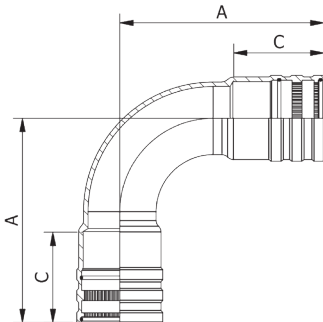

**\*MATERIAL CODE:**  
 K = STAINLESS STEEL  
 G = CARBON STEEL  
 B = COPPER NICKEL 70/30

**ORDER EXAMPLE:**  
 DP40N300G40

## Low Pressure 90° Elbow, NPS - DP40N300

Size NPS	Part Number	Dimensions - Inch (mm)			*Weight K & G lbs (kg)
		A	B	C Insertion Depth	
2-1/2"	DP40N300*40	8.53 (216.66)	3.45 (87.63)	3.75 (95.25)	8.35 (3.79)
3"	DP40N300*48	9.71 (246.63)	4.14 (105.16)	4.35 (110.49)	12.57 (5.70)
4"	DP40N300*64	14.13 (358.90)	5.32 (135.13)	6.75 (171.45)	30.60 (13.88)

PYPLOK® DP 40 Series shapes such Tees, Elbows and ANSI Flanged Ends are made as welded assemblies using ASME B16.9 SCH.40 Butt Weld Fittings.

3D step models available upon request

# DP 40N Series – NPS Low Pressure

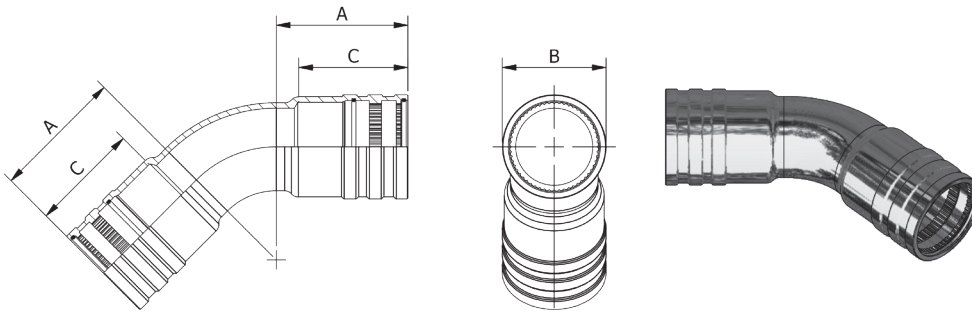

**\*MATERIAL CODE:**  
 K = STAINLESS STEEL  
 G = CARBON STEEL  
 B = COPPER NICKEL 70/30

**ORDER EXAMPLE:**  
 DP40N017G40

## Low Pressure 45° Elbow, NPS - DP40N017

Size NPS	Part Number	Dimensions - Inch (mm)			*Weight K & G lbs (kg)
		A	B	C Insertion Depth	
2-1/2"	DP40N017*40	6.53 (165.86)	3.45 (87.63)	3.75 (95.25)	2.71 (1.23)
3"	DP40N017*48	7.20 (182.88)	4.14 (105.16)	4.35 (110.49)	10.10 (4.58)
4"	DP40N017*64	10.61 (269.49)	5.32 (135.13)	6.75 (171.45)	26.28 (11.92)

PYPLOK® DP 40 Series shapes such Tees, Elbows and ANSI Flanged Ends are made as welded assemblies using ASME B16.9 SCH.40 Butt Weld Fittings.

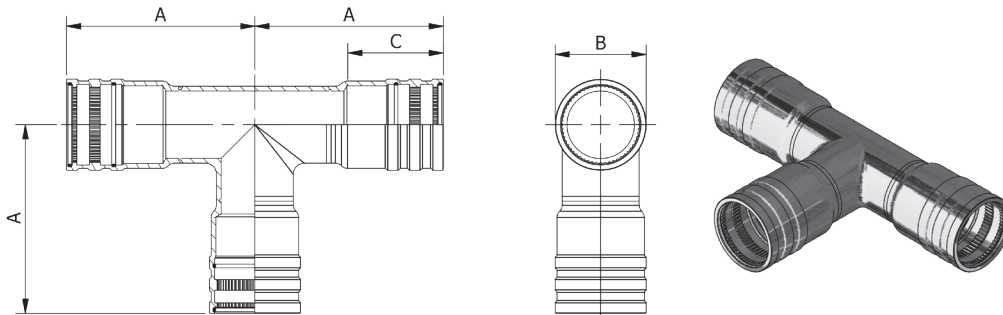

**\*MATERIAL CODE:**  
 K = STAINLESS STEEL  
 G = CARBON STEEL  
 B = COPPER NICKEL 70/30

**ORDER EXAMPLE:**  
 DP40N400G40

## Low Pressure Tee, NPS - DP40N400

Size NPS	Part Number	Dimensions - Inch (mm)			*Weight K & G lbs (kg)
		A	B	C Insertion Depth	
2-1/2"	DP40N400*40	7.78 (197.61)	3.45 (87.63)	3.75 (95.25)	12.80 (5.81)
3"	DP40N400*48	8.58 (217.93)	4.14 (105.16)	4.35 (110.49)	18.10 (8.21)
4"	DP40N400*64	12.25 (311.15)	5.32 (135.13)	6.75 (171.45)	42.12 (19.11)

PYPLOK® DP 40 Series shapes such Tees, Elbows and ANSI Flanged Ends are made as welded assemblies using ASME B16.9 SCH.40 Butt Weld Fittings.

# DP 40N Series – NPS Low Pressure

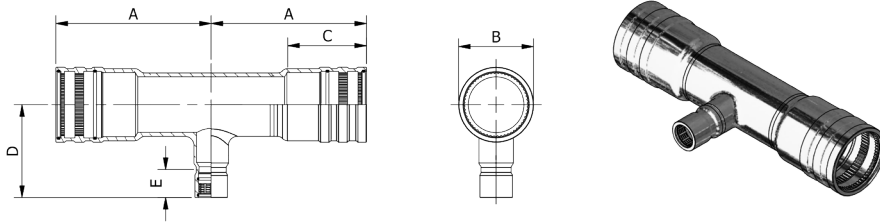

**\*MATERIAL CODE:**  
 K = STAINLESS STEEL  
 G = CARBON STEEL  
 B = COPPER NICKEL 70/30

**ORDER EXAMPLE:**  
 DP40N104G4032

## Low Pressure Reducing Tee, NPS - DP40N104

Port 1 Size NPS	Port 2 Size NPS	Part Number	Dimensions - Inch (mm)					*Weight K & G lbs (kg)
			A	B	C Insertion Depth	D	E Insertion Depth	
2-1/2"	2"	DP40N104*4032	7.78 (197.61)	3.45 (87.63)	3.75 (95.25)	7.48 (189.99)	3.50 (88.90)	11.65 (5.28)
3"	2"	DP40N104*4832	8.58 (217.93)	4.14 (105.16)	4.35 (110.49)	7.76 (197.10)	3.50 (88.90)	15.57 (7.06)
3"	2-1/2"	DP40N104*4840	8.58 (217.93)	4.14 (105.16)	4.35 (110.49)	8.03 (203.96)	3.75 (95.25)	15.72 (7.13)
4"	3"	DP40N104*6448	12.25 (311.15)	5.32 (135.13)	6.75 (171.45)	9.09 (230.89)	4.35 (110.49)	34.60 (15.69)

PYPLOK® DP 40 Series shapes such Tees, Elbows and ANSI Flanged Ends are made as welded assemblies using ASME B16.9 SCH.40 Butt Weld Fittings.

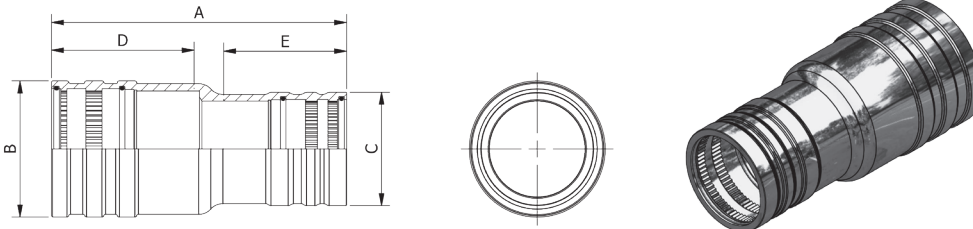

**\*MATERIAL CODE:**  
 K = STAINLESS STEEL  
 G = CARBON STEEL  
 B = COPPER NICKEL 70/30

**ORDER EXAMPLE:**  
 DP40N101G4024

Other configurations available.  
 Contact factory for details.

## Low Pressure Reducer, NPS - DP40N101

End 1 Size NPS	End 2 Size NPS	Part Number	Dimensions - mm (Inch)					*Weight K & G lbs (kg)
			A	B	C	D Insertion Depth	E Insertion Depth	
2-1/2"	1-1/2"	DP40N101*4024	8.00 (203.20)	3.45 (87.63)	2.58 (65.53)	3.75 (95.25)	2.50 (63.50)	5.50 (2.49)
2-1/2"	2"	DP40N101*4032	8.25 (209.55)	3.45 (87.63)	3.04 (77.22)	3.75 (95.25)	3.50 (88.90)	5.42 (2.46)
3"	2"	DP40N101*4832	9.00 (228.60)	4.14 (105.16)	3.04 (77.22)	4.35 (110.49)	3.50 (88.90)	7.21 (3.27)
3"	2-1/2"	DP40N101*4840	9.00 (228.60)	4.14 (105.16)	3.45 (87.63)	4.35 (110.49)	3.75 (95.25)	6.48 (2.94)
4"	3"	DP40N101*6448	13.00 (330.20)	5.35 (135.13)	4.14 (105.16)	6.75 (171.45)	4.35 (110.49)	16.10 (7.30)

3D step models available upon request

# DP 40N Series – NPS Low Pressure

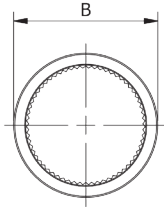
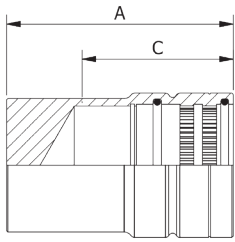

**\*MATERIAL CODE:**  
 K = STAINLESS STEEL  
 G = CARBON STEEL  
 B = COPPER NICKEL 70/30

**ORDER EXAMPLE:**  
 DP40N085G40

## Low Pressure End Cap, NPS - DP40N085

Size NPS	Part Number	Dimensions - Inch (mm)			*Weight K & G lbs (kg)
		A	B	C Insertion Depth	
2-1/2"	DP40N085*40	4.50 (114.30)	3.45 (87.63)	3.75 (95.25)	3.66 (1.66)
3"	DP40N085*48	5.23 (129.54)	4.14 (105.16)	4.35 (110.49)	5.49 (2.49)
4"	DP40N085*64	7.63 (190.50)	5.32 (135.13)	6.75 (171.45)	12.57 (5.70)

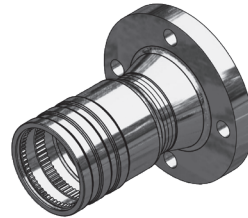
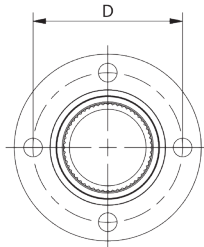
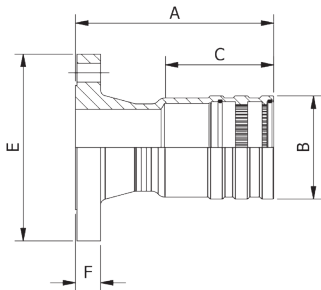

**\*MATERIAL CODE:**  
 K = STAINLESS STEEL  
 G = CARBON STEEL  
 B = COPPER NICKEL 70/30

**ORDER EXAMPLE:**  
 DP40N018G40

## Low Pressure Flange – ANSI 150#, NPS - DP40N018

Size NPS	Flange Size	Part Number	Dimensions - mm (Inch)						Bolt Size	*Weight K & G lbs (kg)
			A	B	C Insertion Depth	D	E	F		
2-1/2"	2-1/2"	DP40N018*40	7.53 (191.26)	3.45 (87.63)	3.75 (95.25)	5.50 (139.70)	7.00 (177.80)	0.94 (23.88)	5/8" UNC	12.73 (5.77)
3"	3"	DP40N018*48	7.96 (202.18)	4.14 (105.16)	4.35 (110.49)	6.00 (152.40)	7.50 (190.50)	0.94 (23.88)	5/8" UNC	19.26 (8.74)
4"	4"	DP40N018*64	11.10 (281.94)	5.32 (135.13)	6.75 (171.45)	7.50 (190.50)	9.00 (228.60)	1.19 (30.23)	5/8" UNC	27.33 (12.40)

PYPLOK® DP 40 Series shapes such as Tees, Elbows and ANSI Flanged Ends are made as welded assemblies using ASME B16.9 SCH.40 Butt Weld Fittings.

# DP 40N Series – NPS Low Pressure

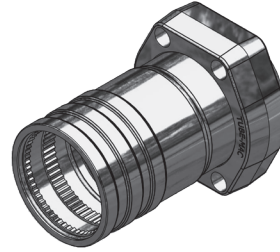
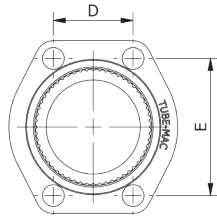
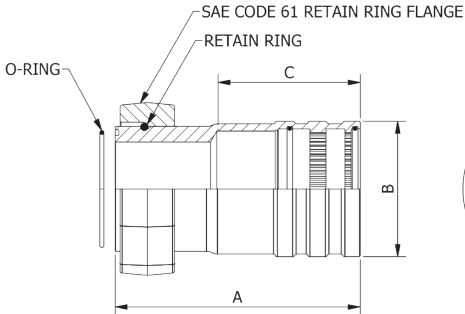

**\*MATERIAL CODE:**  
 K = STAINLESS STEEL  
 G = CARBON STEEL  
 B = COPPER NICKEL 70/30

**ORDER EXAMPLE:**  
 DP40N091G40

## Low Pressure SAE Code 61 Flange, NPS - DP40N091

Size NPS	Flange Size	Part Number	Dimensions - Inch (mm)					Bolt Minimum Grade 8	*Weight K & G lbs (kg)
			A	B	C Insertion Depth	D	E		
2-1/2"	2-1/2"	DP40N091*40	7.00 (177.80)	3.45 (87.63)	3.75 (95.25)	2.00 (50.80)	3.49 (88.65)	1/2" UNC	8.41 (3.81)
3"	3"	DP40N091*48	7.50 (190.50)	4.14 (105.16)	4.35 (110.49)	2.44 (61.98)	4.19 (106.43)	5/8" UNC	12.40 (5.62)
4"	4"	DP40N091*64	11.00 (279.40)	5.32 (135.13)	6.75 (171.45)	3.06 (77.72)	5.13 (130.30)	5/8" UNC	22.65 (10.27)

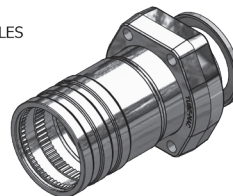
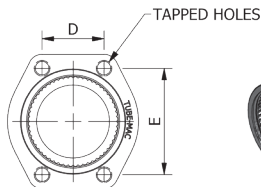
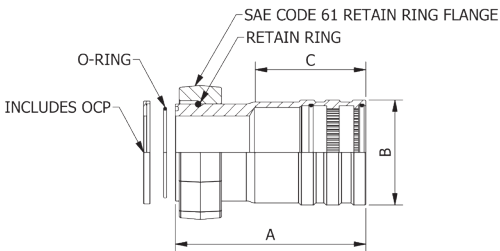

**\*MATERIAL CODE:**  
 K = STAINLESS STEEL  
 G = CARBON STEEL  
 B = COPPER NICKEL 70/30

**ORDER EXAMPLE:**  
 DP40N095G40

## Low Pressure SAE Code 61 Tapped Flange, NPS - DP40N095

Size NPS	Flange Size	Part Number	Dimensions - Inch (mm)					Tap UNC-2B	*Weight K & G lbs (kg)
			A	B	C Insertion Depth	D	E		
2-1/2"	2-1/2"	DP40N095*40	7.00 (177.80)	3.45 (87.63)	3.75 (95.25)	2.00 (50.80)	3.49 (88.65)	1/2"-13	8.41 (3.81)
3"	3"	DP40N095*48	7.50 (190.50)	4.14 (105.16)	4.35 (110.49)	2.44 (61.98)	4.19 (106.43)	5/8"-11	12.40 (5.62)
4"	4"	DP40N095*64	11.00 (279.40)	5.32 (135.13)	6.75 (171.45)	3.06 (77.72)	5.13 (130.30)	5/8"-11	22.65 (10.27)



# General Characteristics

## DP 40M Series - Metric Low Pressure

### Fitting Material Specifications

B = Copper Nickel 70/30  
C = Copper Nickel 90/10

### Material Specification

MIL-C71500  
MIL-C70600

PYPLOK® DP 40M Series shapes such as Tees, Elbows and ANSI Flanged End are made as welded assemblies using ASME B16.9 CL 200 Butt Weld Fitting.

### O-Ring Material Specifications

VITON (Brown Colour)  
EPDM (Black Colour)

### O-Ring Temperature Limits

-15°F to 400°F (-26°C to 205°C)  
-60°F to 400°F (-51°C to 205°C)

For seal compatibility and selection for each system consult factory. Other seal materials for specific applications of compatibility and temperature are available upon request.

### Ordering Information

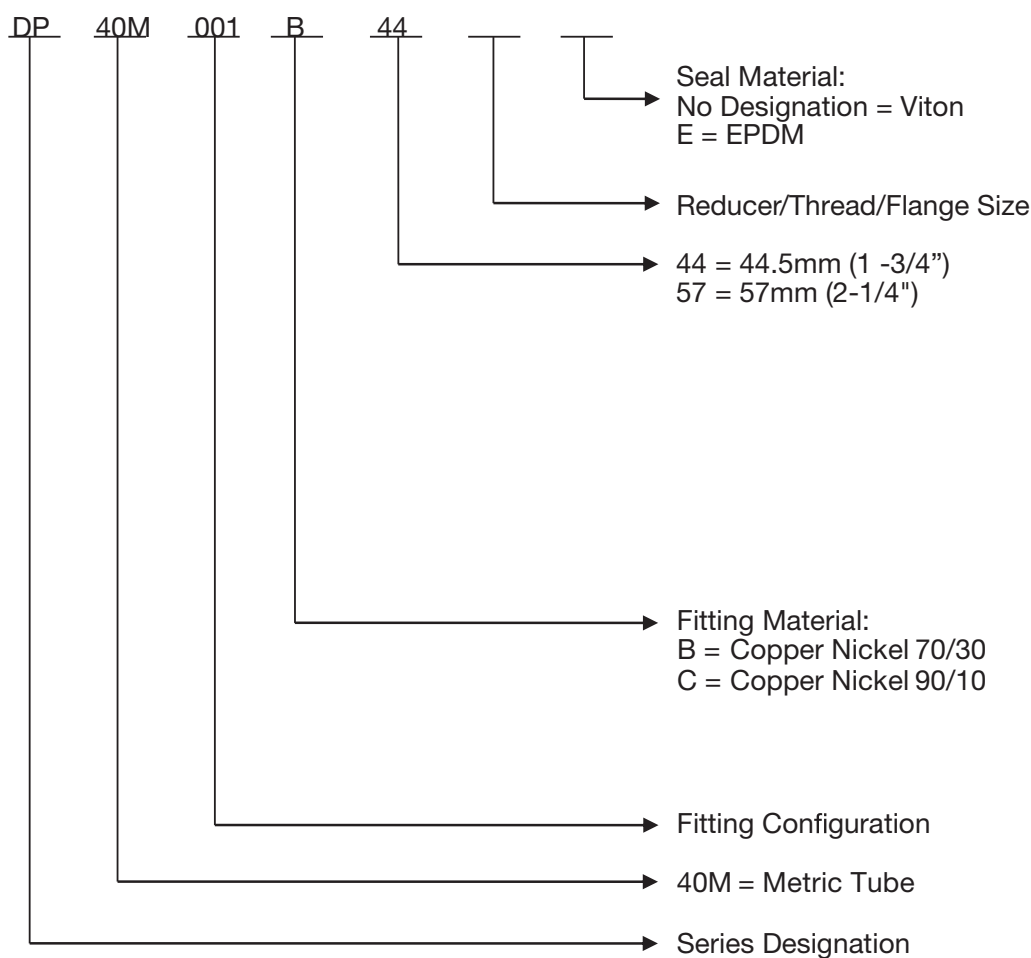

System design and safe application is the responsibility of the end-user. Consideration must be taken to confirm proper fitting selection is made to ensure proper compatibility, function and operation of the fitting within the piping system. The technical and performance information such as weights, dimensions and ratings in this 3D step models available upon request. Tube-Mac® reserves the right to change technical data and product dimension, ratings and other aspects without notice.



# Standard Fitting Configuration Guide

## DP 40M Series - Metric Low Pressure

44mm to 57mm

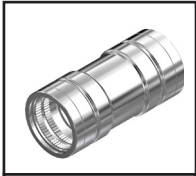

**Coupling**  
DP40M100  
Page G3



**90° Elbow**  
DP40M300  
Page G3

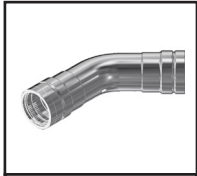

**45° Elbow**  
DP40M017  
Page G4



**Tee**  
DP40M400  
Page G4



**End Cap**  
DP40M085  
Page G5



**Flange - ANSI  
#150**  
DP40M018  
Page G5

# DP 40M Series - Metric Low Pressure

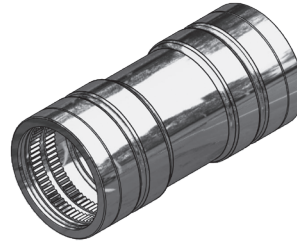
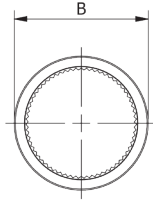
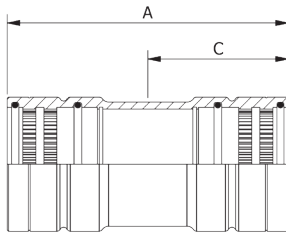

\*MATERIAL CODE:  
B = COPPER NICKEL 70/30

ORDER EXAMPLE:  
DP40M100B44

## Coupling, Metric - DP40M100

Size OD (mm)	Part Number	Dimensions - mm (Inch)			*Weight B kg (lbs)
		A	B	C Insertion Depth	
44.5	DP40M100B44	115.01 (4.53)	54.89 (2.16)	57.50 (2.26)	0.59 (1.31)
57	DP40M100B57	125.00 (4.92)	66.80 (2.63)	62.48 (2.46)	0.69 (1.52)

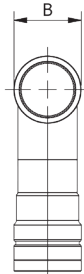
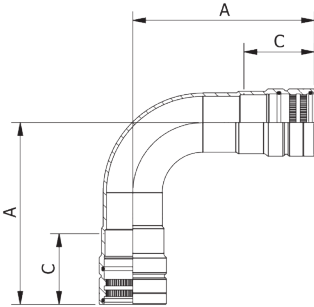

\*MATERIAL CODE:  
B = COPPER NICKEL 70/30

ORDER EXAMPLE:  
DP40M300B44

## 90° Elbow, Metric - DP40M300

Size OD (mm)	Part Number	Dimensions - mm (Inch)			*Weight B kg (lbs)
		A	B	C Insertion Depth	
44.5	DP40M300B44	148.11 (5.83)	54.89 (2.16)	57.50 (2.26)	1.02 (2.24)
57	DP40M300B57	177.04 (6.97)	66.80 (2.63)	62.48 (2.46)	1.92 (4.23)

PYPLOK® DP 40 Series shapes such as Tees, Elbows and ANSI Flanged Ends are made as welded assemblies using ASME B16.9 CL200 Butt Weld Fittings.

# DP 40M Series - Metric Low Pressure

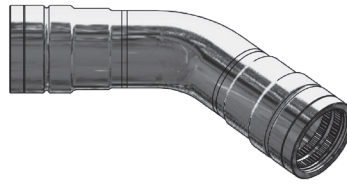
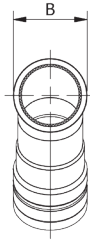
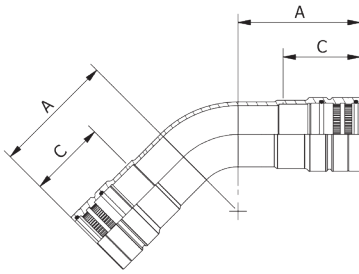

\*MATERIAL CODE:  
B = COPPER NICKEL 70/30

ORDER EXAMPLE:  
DP40M017B44

## 45° Elbow, Metric - DP40M017

Size OD (mm)	Part Number	Dimensions - mm (Inch)			*Weight B kg (lbs)
		A	B	C Insertion Depth	
44.5	DP40M017B44	113.54 (4.47)	54.89 (2.16)	57.50 (2.26)	0.91 (2.01)
57	DP40M017B57	177.04 (6.97)	66.80 (2.63)	62.48 (2.46)	1.54 (3.40)

PYPLOK® DP 40 Series shapes such Tees, Elbows and ANSI Flanged Ends are made as welded assemblies using ASME B16.9 CL200 Butt Weld Fittings.

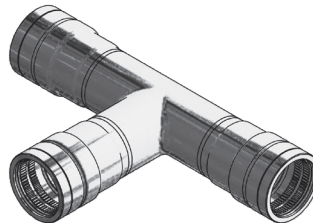
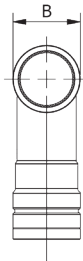
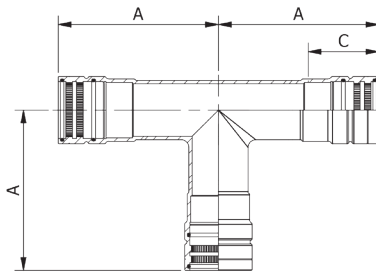

\*MATERIAL CODE:  
B = COPPER NICKEL 70/30

ORDER EXAMPLE:  
DP40M400B44

## Tee, Metric - DP40M400

Size OD (mm)	Part Number	Dimensions - mm (Inch)			*Weight B kg (lbs)
		A	B	C Insertion Depth	
44.5	DP40M400B44	130.56 (5.14)	54.89 (2.16)	57.50 (2.26)	1.39 (3.07)
57	DP40M400B57	146.05 (5.75)	66.80 (2.63)	62.48 (2.46)	2.39 (5.27)

PYPLOK® DP 40 Series shapes such Tees, Elbows and ANSI Flanged Ends are made as welded assemblies using ASME B16.9 CL200 Butt Weld Fittings.

# DP 40M Series - Metric Low Pressure

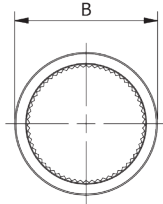
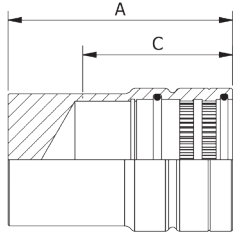

\*MATERIAL CODE:  
B = COPPER NICKEL 70/30

ORDER EXAMPLE:  
DP40M085B44

## End Cap, Metric - DP40M085

Size OD (mm)	Part Number	Dimensions - mm (Inch)			*Weight B kg (lbs)
		A	B	C Insertion Depth	
44.5	DP40M085B44	86.36 (3.40)	54.89 (2.16)	57.50 (2.26)	0.70 (1.55)
57	DP40M085B57	89.66 (3.53)	66.80 (2.63)	62.48 (2.46)	0.98 (2.16)

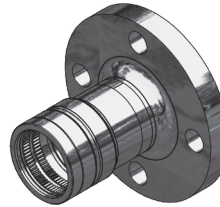
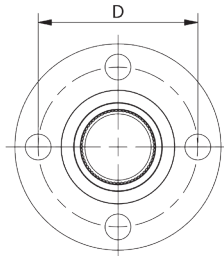
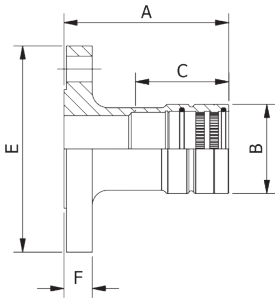

\*MATERIAL CODE:  
B = COPPER NICKEL 70/30

ORDER EXAMPLE:  
DP40M118B44

## Flange - ANSI #150, Metric - DP40M018

Size OD (mm)	Flange Size	Part Number	Dimensions - mm (Inch)						*Weight B kg (lbs)
			A	B	C Insertion Depth	D	E	F	
44.5	1-1/2"	DP40M018B4424	104.78 (4.13)	54.89 (2.16)	57.50 (2.26)	98.55 (3.88)	127.00 (5.00)	17.53 (0.69)	1.98 (4.37)
57	2"	DP40M018B5732	114.30 (4.50)	66.80 (2.63)	62.48 (2.46)	120.65 (4.75)	152.40 (6.00)	19.05 (0.75)	3.01 (6.63)

PYPLOK® DP 40 Series shapes such as Tees, Elbows and ANSI Flanged Ends are made as welded assemblies using ASME B16.9 CL200 Butt Weld Fittings.

3D step models available upon request



# PYPLOK® Tooling

## The PYPLOK® Tooling System Consists of the Following Items

- Tube-Mac® Swage Tooling
- 10,000 PSI/690 bar Hydraulic Power Supply
- Inspection/Marking Gauges

## Swage Tooling

The tools are lightweight, portable and activated by 10,000 PSI/690 bar hydraulic pressure. The swage tools are identical in design. The only difference is the force generated by each model.

The following models are used to install the PYPLOK® fittings:

DLT10 – 1/4" OD and 6mm-8mm

DLT20 – 1/4"-3/8" NPS, 1/4"-5/8" OD and 6mm-16mm

DLT40 – 1/4"-3/4" NPS, 3/8"-1" OD and 8mm-30mm

DLT55 – 1/2"-1-1/2" NPS, 1"-2" OD and 22mm-57mm

DLT70 – 1"-3" NPS, 1-1/2"-2" OD and 35mm-76mm

DLT86 – 3"-4" NPS

## Swage Tooling Primary Components

The PYPLOK® swage tooling assembly has four main components:

- Power Unit
- Head Assembly
- Swage Dies
- Die Block Assembly

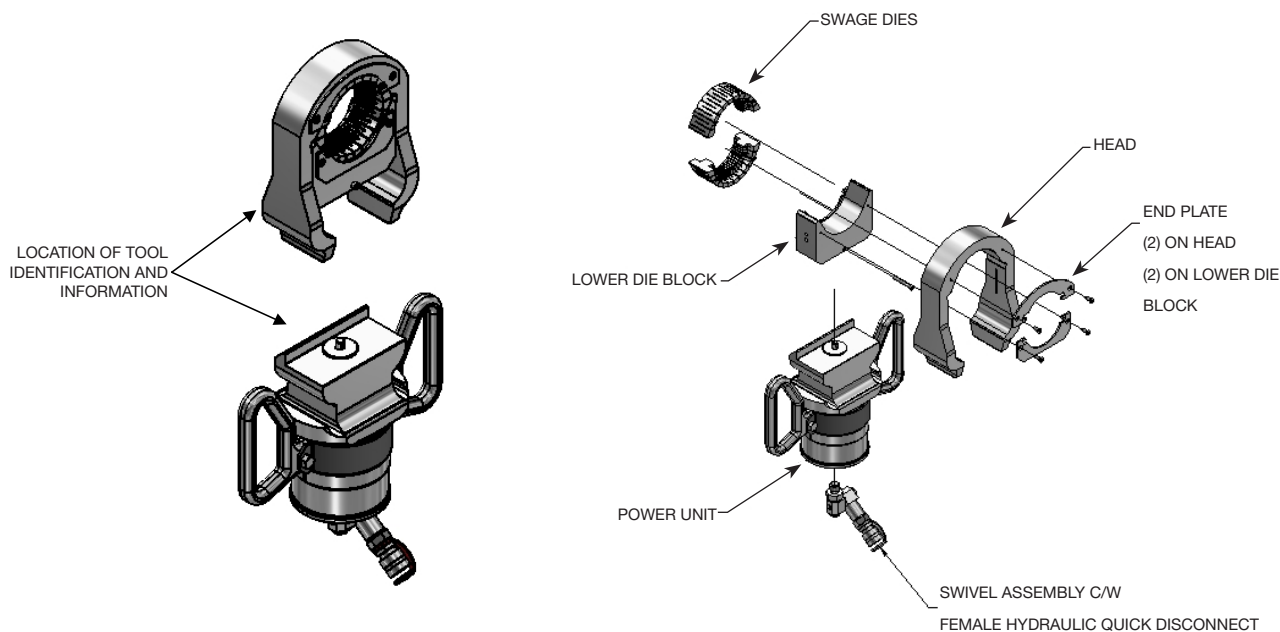

# PYPLOK® Tooling Dimensions

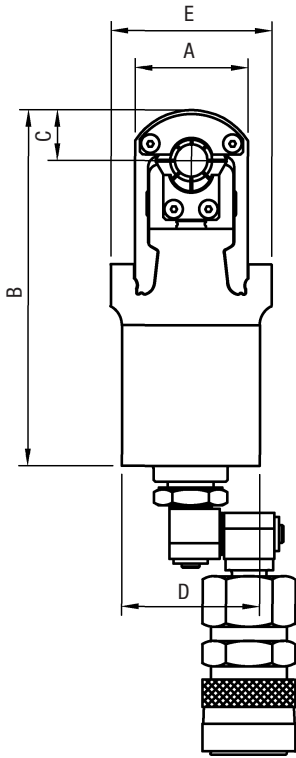

## Model 10

Head Size	Dimensions - Inch (mm)				
	A	B	C	D	E
01' Series	1.33 (33.86)	4.22 (107.21)	0.60 (15.24)	1.63 (41.40)	1.90 (48.26)

Head Size	Weight - lbs (kg)		
	Power Unit	Head Assembly	Complete Tool
01' Series	2.00 (0.90)	0.03 (0.20)	2.40 (1.10)

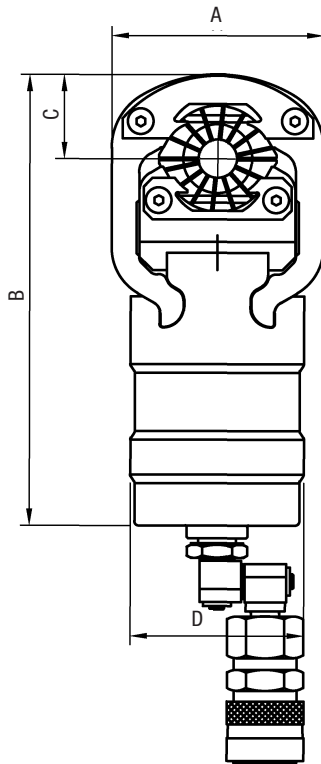

## Model 20

Head Size	Dimensions - Inch (mm)			
	A	B	C	D
00' Series	3.04 (77.22)	6.48 (164.67)	1.21 (30.84)	2.49 (63.25)

Head Size	Weight - lbs (kg)		
	Power Unit	Head Assembly	Complete Tool
00' Series	4.40 (2.00)	3.10 (1.40)	7.50 (3.40)

# PYPLOK® Tooling Dimensions

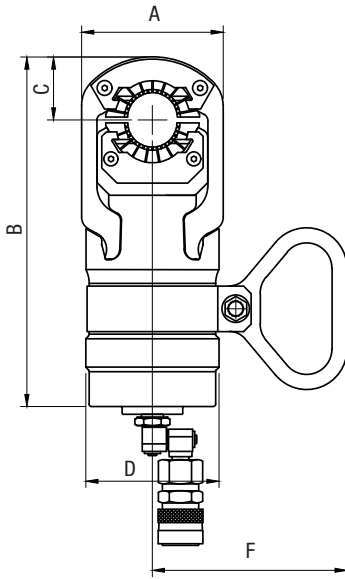

## \*Model 40

Head Size	Dimensions - Inch (mm)				
	A	B	C	D	F
00' Series	3.29 (83.57)	8.23 (209.12)	1.15 (29.26)	3.29 (83.59)	4.81 (122.23)
02' Series	3.50 (88.88)	8.63 (219.28)	1.55 (39.45)	3.29 (83.59)	4.81 (122.23)

Head Size	Weight - lbs (kg)		
	Power Unit	Head Assembly	Complete Tool
00' Series	9.20 (4.20)	4.20 (1.90)	13.40 (6.10)
02' Series	9.20 (4.20)	5.30 (2.40)	14.60 (6.60)

\*Handle is an option. Not standard with model 40.

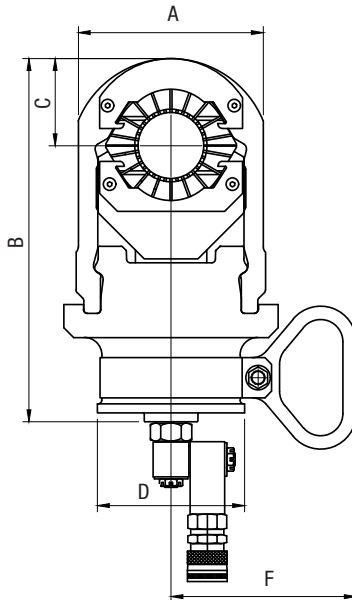

## \*Model 55

Head Size	Dimensions - Inch (mm)				
	A	B	C	D	F
01' Series	5.18 (131.57)	9.92 (251.92)	2.43 (61.70)	4.12 (104.65)	5.19 (131.78)

Head Size	Weight - lbs (kg)		
	Power Unit	Head Assembly	Complete Tool
01' Series	16.70 (7.60)	11.20 (5.10)	27.90 (12.70)

\*Handle is an option. Not standard with model 55.

Introduction

Technical Information

DM 20 – NPS Pipe

DM 60 – OD Tube

DM 80 – Metric Tube

DM Series Thread Adapter

DM 80 – Metric & JIS Tube

DP 40N – NPS Low Pressure

DP40M – Metric Low Pressure

PYPLOK® Tooling

Installation Procedures

Appendix



# PYPLOK® Tooling Dimensions

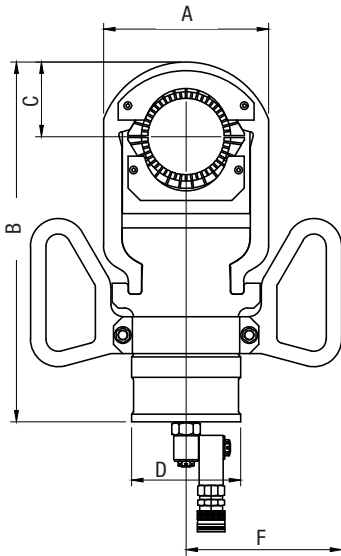

## \*Model 70

Head Size	Dimensions - Inch (mm)				
	A	B	C	D	F
01' Series	6.68 (169.70)	14.62 (371.45)	3.03 (76.99)	4.41 (112.07)	6.30 (159.97)
02' Series	7.55 (191.77)	15.23 (386.77)	3.62 (92.05)	4.41 (112.07)	6.30 (159.97)

Head Size	Weight - lbs (kg)		
	Power Unit	Head Assembly	Complete Tool
01' Series	30.80 (14.00)	17.60 (8.00)	48.40 (22.00)
02' Series	30.80 (14.00)	23.10 (10.50)	53.90 (24.50)

\*Handle comes standard with model 70.

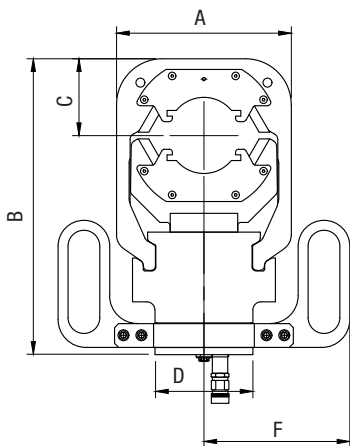

## \*Model 86

Head Size	Dimensions - Inch (mm)				
	A	B	C	D	F
00' Series	11.00 (279.40)	19.50 (495.30)	5.00 (127.00)	6.25 (158.75)	18.00 (457.20)

Head Size	Weight - lbs (kg)		
	Power Unit	Head Assembly	Complete Tool
00' Series	61.70 (28.00)	62.20 (28.20)	123.90 (56.20)

\*Handle comes standard with model 86.

# PYPLOK® Tooling Size Range Coverage

DM 20 Series - NPS Pipe									
	1/4"	3/8"	1/2"	3/4"	1"	1-1/4"	1-1/2"	2"	3"
Model 20									
Model 40									
Model 55									
Model 70									
Model 86									

DM 60 Series - OD Tube									
	1/4"	3/8"	1/2"	5/8"	3/4"	1"	1-1/4"	1-1/2"	2"
Model 10									
Model 20									
Model 40									
Model 55									
Model 70									

DM 80 Series - Metric Tube																	
	6mm	8mm	10mm	12mm	15mm	16mm	18mm	20mm	22mm	25mm	28mm	30mm	35mm	38mm	42mm	50mm	60mm
Model 10																	
Model 20																	
Model 40																	
Model 55																	
Model 70																	

DP 40N Series - NPS Low Pressure			
	2-1/2"	3"	4"
Model 70			
Model 86			

DP 40M Series - Metric Low Pressure		
	44.5mm	57mm
Model 55		

Introduction

Technical Information

DM 20 – NPS Pipe

DM 60 – OD Tube

DM 80 – Metric Tube

DM Series Thread Adapter

DM 80 – Metric & JIS Tube

DP 40N – NPS Low Pressure

DP 40M – Metric Low Pressure

PYPLOK® Tooling

Installation Procedures

Appendix

# PYPLOK® Tool Matrix

## DM 20 Series - NPS Pipe

### Model 40 Power Unit - DLT40MAPW0000

Size	Fitting Series	Inspection Gauge	Die Set	Die Block	Head	Upper Endplates	Lower Endplates	Endplate Bolts	*Head Assembly	
Model 40-00' Series										
1/4"	DM 20 Series	DLT40PYIG3804	DLT40PYDI3804	DLT40MADA0000	DLT40MAHD0000	DLT40PYEU0000	DLT40PYEL0000	MS51595-61 10-24 x 3/8" Flat Socket Cap	DLT40PYHA3804	
3/8"		DLT40PYIG3806	DLT40PYDI3806						DLT40PYHA3806	
Model 40 - 02' Series										
1/2"	DM 20 Series	DLT40PYIG3808	DLT40PYDI3808	DLT40MADA0002	DLT40MAHD0002	DLT40PYEU0002	DLT40PYEL0002		DLT40PYHA3808	
3/4"		DLT40PYIG3812	DLT40PYDI3812					DLT40PYHA3812		

### Model 55 Power Unit - DLT55MAPW0000

Size	Fitting Series	Inspection Gauge	Die Set	Die Block	Head	Upper Endplates	Lower Endplates	Endplate Bolts	*Head Assembly
Model 55 - 01' Series									
1/2"	DM 20 Series	DLT40PYIG3808	DLT55PYDI3808	DLT55MADA0001	DLT55MAHD0001	DLT55PYEU0001	DLT55PYEL0001	MS51595-61 10-24 x 3/8" Flat Socket Cap	DLT55PYHA3808
3/4"		DLT40PYIG3812	DLT55PYDI3812						DLT55PYHA3812
1"		DLT55PYIG3816	DLT55PYDI3816						DLT55PYHA3816
1-1/4"		DLT55PYIG3820	DLT55PYDI3820						DLT55PYHA3820
1-1/2"		DLT55PYIG3824	DLT55PYDI3824						DLT55PYHA3824

### Model 70 Power Unit - DLT70MAPW0000

Size	Fitting Series	Inspection Gauge	Die Set	Die Block	Head	Upper Endplates	Lower Endplates	Endplate Bolts	*Head Assembly
Model 70 - 01' Series									
1"	DM 20 Series	DLT55PYIG3816	DLT70PYDI3816	DLT70MADA0001	DLT70MAHD0001	DLT70PYEU0001	DLT70PYEL0001	MS51595-61 10-24 x 3/8" Flat Socket Cap	DLT70PYHA3816
1-1/4"		DLT55PYIG3820	DLT70PYDI3820						DLT70PYHA3820
1-1/2"		DLT55PYIG3824	DLT70PYDI3824						DLT70PYHA3824
2"		DLT70PYIG3832	DLT70PYDI3832						DLT70PYHA3832

### Model 86 Power Unit - DLT86MAPW0000

Size	Fitting Series	Inspection Gauge	Die Set	Die Block	Head	Upper Endplates	Lower Endplates	Endplate Bolts	*Head Assembly
Model 86 - 00' Series									
3"	DM 20 Series	DLT86PYIG3848	DLT86PYDI3848	DLT86MADA0000	DLT86MAHD0000	DLT86PYEU0001	DLT86PYEL0001	1/4-28 x 1/2" Socket Cap	DLT86PYHA3848

\*Head Assembly Includes: Die Set, Die Block, Head, Endplates and Endplate Bolts

# PYPLOK® Tool Matrix

## DM 60 Series - OD Tube

### Model 10 Power Unit - DLT10MAPW0000

Size	Fitting Series	Inspection Gauge	Die Set	Die Block	Head	Upper Inboard	Upper Outboard	Lower Inboard	Lower Outboard	*Head Assembly
Model 10 - 01' Series										
1/4"	DM 60 Series	DLT10PYIG3704	DLT10PYDI3704	DLT10MADA0001	DLT10MAHD0001	DLT10PSEU4006	DLT10PYFU704	DLT10PSEL4006	DLT10PSFL4006	DLT10PYHA3704

### Model 20 Power Unit - DLT20MAPW0000

Size	Fitting Series	Inspection Gauge	Die Set	Die Block	Head	Upper Endplates	Lower Endplates	Endplate Bolts	*Head Assembly
Model 20 - 00' Series									
3/8"	DM 60 Series	DLT40PYIG3706	DLT20PYDI3706	DLT20MADA0001	DLT20MADA0000	DLT40PYEU0000	DLT40PYEL0000	MS51595-61 10-24 x 3/8" Flat Socket Cap	DLT20PYHA3706
1/2"		DLT40PYIG3708	DLT20PYDI3708						DLT20PYHA3708
5/8"		DLT40PYIG3710	DLT20PYDI3916						DLT20PYHA3916

### Model 40 Power Unit - DLT40MAPW0000

Size	Fitting Series	Inspection Gauge	Die Set	Die Block	Head	Upper Endplates	Lower Endplates	Endplate Bolts	*Head Assembly
Model 40 - 00' Series									
3/8"	DM 60 Series	DLT40PYIG3706	DLT40PYDI3706	DLT40MADA0000	DLT40MAHD0000	DLT40PYEU0000	DLT40PYEL0000	MS51595-61 10-24 x 3/8" Flat Socket Cap	DLT40PYHA3706
1/2"		DLT40PYIG3708	DLT40PYDI3708						DLT40PYHA3708
5/8"		DLT40PYIG3710	DLT40PYDI3916						DLT40PYHA3916
Model 40 - 02' Series									
3/4"	DM 60 Series	DLT40PYIG3712	DLT40PYDI3712	DLT40MADA0002	DLT40MAHD0002	DLT40PYEU0002	DLT40PYEL0002		DLT40PYHA3712
1"		DLT40PYIG3716	DLT40PYDI3716						DLT40PYHA3716

### Model 55 Power Unit - DLT55MAPW0000

Size	Fitting Series	Inspection Gauge	Die Set	Die Block	Head	Upper Endplates	Lower Endplates	Endplate Bolts	*Head Assembly
Model 55 - 01' Series									
1"	DM 60 Series	DLT40PYIG3716	DLT55PYDI3716	DLT55MADA0001	DLT55MAHD0001	DLT55PYEU0001	DLT55PYEL0001	MS51595-61 10-24 x 3/8" Flat Socket Cap	DLT55PYHA3716
1-1/4"		DLT55PYIG3720	DLT55PYDI3720						DLT55PYHA3720
1-1/2"		DLT55PYIG3938	DLT55PYDI3938						DLT55PYHA3938
2"		DLT55PYIG3732	DLT55PYDI3824						DLT55PYHA3824

\*Head Assembly Includes: Die Set, Die Block, Head, Endplates and Endplate Bolts

Introduction

Technical Information

DM 20 - NPS Pipe

DM 60 - OD Tube

DM 80 - Metric Tube

DM Series Thread Adapter

DM 80 - Metric & JIS Tube

DP 40N - NPS Low Pressure

DP 40M - Metric Low Pressure

PYPLOK® Tooling

Installation Procedures

Appendix

J7

# PYPLOK® Tool Matrix

## DM 80 Series - Metric Tube

Model 10 Power Unit - DLT10MAPW0000										
Size	Fitting Series	Inspection Gauge	Die Set	Die Block	Head	Upper Inboard	Upper Outboard	Lower Inboard	Lower Outboard	*Head Assembly
Model 10 - 01' Series										
6mm	DM 80 Series	DLT10PYIG3906	DLT10PYDI3704	DLT10MADA0001	DLT10MAHD0001	DLT10PSEU4006	DLT10PYFU704	DLT10PSEL4006	DLT10PSFL4006	DLT10PYHA3704
8mm		DLT10PYIG3908	DLT10PYDI3908							DLT10PYHA3908

Model 20 Power Unit - DLT20MAPW0000										
Size	Fitting Series	Inspection Gauge	Die Set	Die Block	Head	Upper Endplates	Lower Endplates	Endplate Bolts	*Head Assembly	
Model 20 - 00' Series										
8mm	DM 80 Series	DLT40PYIG3908	DLT20PYDI3908	DLT20MADA0000	DLT20MAHD0000	DLT40PYEU0000	DLT40PYEL0000	MS51595-61 10-24 x 3/8" Flat Socket Cap	DLT20PYHA3908	
10mm		DLT40PYIG3910	DLT20PYDI3910						DLT20PYHA3910	
12mm		DLT40PYIG3912	DLT20PYDI3912						DLT20PYHA3912	
15mm		DLT40PYIG3915	DLT20PYDI3916						DLT20PYHA3916	
16mm		DLT40PYIG3916	DLT20PYDI3916						DLT20PYHA3916	

Model 40 Power Unit - DLT40MAPW0000										
Size	Fitting Series	Inspection Gauge	Die Set	Die Block	Head	Upper Endplates	Lower Endplates	Endplate Bolts	*Head Assembly	
Model 40 - 00' Series										
8mm	DM 80 Series	DLT40PYIG3908	DLT20PYDI3908	DLT40MADA0000	DLT40MAHD0000	DLT40PYEU0000	DLT40PYEL0000	MS51595-61 10-24 x 3/8" Flat Socket Cap	DLT40PYHA3908	
10mm		DLT40PYIG3910	DLT40PYDI3910						DLT40PYHA3910	
12mm		DLT40PYIG3912	DLT40PYDI3912						DLT40PYHA3912	
14mm		DLT40PYIG3914	DLT40PYDI3804						DLT40PYHA3804	
15mm		DLT40PYIG3915	DLT40PYDI3916						DLT40PYHA3916	
16mm		DLT40PYIG3916	DLT40PYDI3916						DLT40PYHA3916	
18mm		DLT40PYIG3918	DLT40PYDI3806						DLT40PYHA3806	
20mm	DLT40PYIG3920	DLT40PYDI3920	DLT40PYHA3920							
Model 40 - 02' Series										
22mm	DM 80 Series	DLT40PYIG3922	DLT40PYDI3808	DLT40MADA0002	DLT40MAHD0002	DLT40PYEU0002	DLT40PYEL0002	MS51595-61 10-24 x 3/8" Flat Socket Cap	DLT40PYHA3808	
25mm		DLT40PYIG3925	DLT40PYDI3925						DLT40PYHA3925	
28mm		DLT40PYIG3928	DLT40PYDI3812						DLT40PYHA3812	
30mm		DLT40PYIG3930	DLT40PYDI3930						DLT40PYHA3930	

\*Head Assembly Includes: Die Set, Die Block, Head, Endplates and Endplate Bolts

# PYPLOK® Tool Matrix

## DM 80 Series - Metric Tube

### Model 55 Power Unit - DLT55MAPW0000

Size	Fitting Series	Inspection Gauge	Die Set	Die Block	Head	Upper Endplates	Lower Endplates	Endplate Bolts	*Head Assembly
Model 55 - 01' Series									
22mm	DM 80 Series	DLT40PYIG3922	DLT55PYDI3808	DLT55MADA0001	DLT55MAHD0001	DLT55PYEU0001	DLT55PYEU0001	MS51595-61 10-24 x 3/8" Flat Socket Cap	DLT55PYHA3808
25mm		DLT40PYIG3925	DLT55PYDI3925						DLT55PYHA3925
28mm		DLT40PYIG3928	DLT55PYDI3812						DLT55PYHA3812
30mm		DLT40PYIG3930	DLT55PYDI3930						DLT55PYHA3930
35mm		DLT55PYIG3935	DLT55PYDI3816						DLT55PYHA3816
38mm		DLT55PYIG3938	DLT55PYDI3938						DLT55PYHA3938
42mm		DLT55PYIG3820	DLT55PYDI3820						DLT55PYHA3820
50mm		DLT55PYIG3950	DLT55PYDI3824						DLT55PYHA3824

### Model 70 Power Unit - DLT70MAPW0000

Size	Fitting Series	Inspection Gauge	Die Set	Die Block	Head	Upper Endplates	Lower Endplates	Endplate Bolts	*Head Assembly
Model 70 - 01' Series									
35mm	DM 80 Series	DLT55PYIG3935	DLT70PYDI3816	DLT70MADA0001	DLT70MAHD0001	DLT70PYEU0001	DLT70PYEL0001	MS51595-61 10-24 x 3/8" Flat Socket Cap	DLT70PYHA3816
38mm		DLT55PYIG3938	DLT70PYDI3938						DLT70PYHA3938
42mm		DLT55PYIG3820	DLT70PYDI3820						DLT70PYHA3820
50mm		DLT55PYIG3950	DLT70PYDI3824						DLT70PYHA3824
60mm		DLT70PYIG3832	DLT70PYDI3832						DLT70PYHA3832

\*Head Assembly Includes: Die Set, Die Block, Head, Endplates and Endplate Bolts

Introduction

Technical Information

DM 20 - NPS Pipe

DM 60 - OD Tube

DM 80 - Metric Tube

DM Series Thread Adapter

DM 80 - Metric & JIS Tube

DP 40N - NPS Low Pressure

DP 40M - Metric Low Pressure

PYPLOK® Tooling

Installation Procedures

Appendix

# PYPLOK® Tool Matrix

## DM 80 Series - JIS Metric Tube

### Model 40 Power Unit - DLT40MAPW0000

Size	Fitting Series	Inspection Gauge	Die Set	Die Block	Head	Upper Endplates	Lower Endplates	Endplate Bolts	*Head Assembly
Model 40-00' Series									MS51595-61 10-24 x 3/8" Flat Socket Cap
1/4"	08A	DLT40PYIG3908A	DLT40PYDI3804	DLT40MADA0000	DLT40MAHD0000	DLT40PYEU0000	DLT40PYEL0000	DLT40PYHA3804	
3/8"	10A	DLT40PYIG3910A	DLT40PYDI3806					DLT40PYHA3806	
Model 40 - 02' Series									
1/2"	15A	DLT40PYIG3915A	DLT40PYDI3808	DLT40MADA0002	DLT40MAHD0002	DLT40PYEU0002	DLT40PYEL0002	DLT40PYHA3808	
3/4"	20A	DLT40PYIG3920A	DLT40PYDI3812					DLT40PYHA3812	

### Model 55 Power Unit - DLT55MAPW0000

Size	Fitting Series	Inspection Gauge	Die Set	Die Block	Head	Upper Endplates	Lower Endplates	Endplate Bolts	*Head Assembly
Model 55 - 01' Series									MS51595-61 10-24 x 3/8" Flat Socket Cap
1/2"	15A	DLT40PYIG3915A	DLT55PYDI3808	DLT55MADA0001	DLT55MAHD0001	DLT55PYEU0001	DLT55PYEL0001	DLT55PYHA3808	
3/4"	20A	DLT40PYIG3920A	DLT55PYDI3812					DLT55PYHA3812	
1"	25A	DLT55PYIG3925A	DLT55PYDI3816					DLT55PYHA3816	
1-1/4"	32A	DLT55PYIG3932A	DLT55PYDI3820					DLT55PYHA3820	
1-1/2"	40A	DLT55PYIG3940A	DLT55PYDI3824					DLT55PYHA3824	

### Model 70 Power Unit - DLT70MAPW0000

Size	Fitting Series	Inspection Gauge	Die Set	Die Block	Head	Upper Endplates	Lower Endplates	Endplate Bolts	*Head Assembly
Model 70 - 01' Series									MS51595-61 10-24 x 3/8" Flat Socket Cap
1"	25A	DLT55PYIG3925A	DLT70PYDI3816	DLT70MADA0001	DLT70MAHD0001	DLT70PYEU0001	DLT70PYEL0001	DLT70PYHA3816	
1-1/4"	32A	DLT55PYIG3932A	DLT70PYDI3820					DLT70PYHA3820	
1-1/2"	40A	DLT55PYIG3940A	DLT70PYDI3824					DLT70PYHA3824	
2"	50A	DLT70PYIG3950A	DLT70PYDI3832					DLT70PYHA3832	

\*Head Assembly Includes: Die Set, Die Block, Head, Endplates and Endplate Bolts

# PYPLOK® Tool Matrix

## DP 40N Series - NPS Low Pressure

Model 70 Power Unit - DLT70MAPW0000									
Size	Fitting Series	Inspection Gauge	Die Set	Die Block	Head	Upper Endplates	Lower Endplates	Endplate Bolts	*Head Assembly
Model 70 - 02' Series									
2-1/2"	DP 40N Series	DLT70PYIG4040	DLT70PYDI4040	DLT70MADA0002	DLT70MAHD0002	DLT70PYEU0002	DLT70PYEL0002	MS51595-61 10-24 x 3/8" Flat Socket Cap	DLT70PYHA4040
3"		DLT70PYIG4048	DLT70PYDI4048						DLT70PYHA4048

Model 86 Power Unit - DLT86MAPW0000									
Size	Fitting Series	Inspection Gauge	Die Set	Die Block	Head	Upper Endplates	Lower Endplates	Endplate Bolts	*Head Assembly
Model 86 - 00' Series									
4"	DP 40N Series	DLT86PYIG4064	DLT86PYDI4064	DLT86MADA0000	DLT86MAHD0000	DLT86PYEP0001	DLT86PYEP0001	1/4-28 x 1/2" Socket Cap	DLT86PYHA4064

\*Head Assembly Includes: Die Set, Die Block, Head, Endplates and Endplate Bolts

## DP 40M Series - Metric Low Pressure

Model 55 Power Unit - DLT55MAPW0000									
Size	Fitting Series	Inspection Gauge	Die Set	Die Block	Head	Upper Endplates	Lower Endplates	Endplate Bolts	*Head Assembly
Model 55 - 01' Series									
44.5mm	DP 40M Series	DLT55PYIG4244	DLT55PYDI3944	DLT55MADA0001	DLT55MAHD0001	DLT55PYEU0001	DLT55PYEL0001	MS51595-61 10-24 x 3/8" Flat Socket Cap	DLT55PYHA3944
57mm		DLT55PYIG4257	DLT55PYDI3957						DLT55PYHA3957

\*Head Assembly Includes: Die Set, Die Block, Head, Endplates and Endplate Bolts

Introduction

Technical Information

DM 20 - NPS Pipe

DM 60 - OD Tube

DM 80 - Metric Tube

DM Series Thread Adapter

DM 80 - Metric & JIS Tube

DP 40N - NPS Low Pressure

DP 40M - Metric Low Pressure

PYPLOK® Tooling

Installation Procedures

Appendix



# PYPLOK® Tooling

## PYPLOK® Tooling CE Compliance

The PYPLOK® swage tooling assembly has four main components:

- Power Unit
- Head Assembly
- Swage Dies
- Die Block Assembly

## PYPLOK® Swaging Tool Pump Requirements

1. Depending on application and environment the choice of Electric, Battery, Pneumatic or Hand Operated pumps can be used.
2. The hydraulic pumps used for operation of the PYPLOK® Tooling must be capable of producing up to but not exceeding 10,000 PSI/690 bar and have internal relief valve to prevent pump from producing more than 10,000 PSI/690 bar within the PYPLOK® Tools.
3. Power operated pumps must operate in hold-to-run mode (hydraulic supply only as long as push-button or pedal is activated, hydraulic Stop or Release when push-button or pedal are released). PYPLOK® has defined PL = c (EN ISO 13849) as requirement for the control circuit.
4. The hydraulic hose and quick connectors joining the pump to the PYPLOK® Tooling must be rated for use with a 10,000 PSI/690 bar Pump.

## Pumps Offered by Tube-Mac® for Use with the PYPLOK® Tooling

Part Number	Description	Weight lbs (kg)
P392	Hand Pump	9.00 (4.10)
XA11G	Pneumatic Pump	19.40 (8.80)
PUD1100EU102	220 Volt Electric Pump	31.00 (14.05)
PUD1100BU112	110 Volt Electric Pump	31.00 (14.05)
XC1201MB	Battery Pump, 110V Charger	20.28 (9.20)
XC1201ME	Battery Pump, 220V Charger	20.28 (9.20)

Pumps come complete with carrying case and a 10 ft., 10,000 PSI/690 bar, non-conductive hose



# PYPLOK® Tooling Accessories

## PYPLOK® Tooling Accessories

DLT10PYCC1200	Case for (1) Model 10 Power Unit and (2) Head Assemblies
DLT20PYCC1200	Case for (1) Model 20 Power Unit and (2) Head Assemblies
DLT40PYCC1501	Case for (1) Model 40 Power Unit and (6) Head Assemblies
DLT55PYCC1501	Case for (1) Model 55 Power Unit and (1) Head Assembly
DLT55PYCC1502	Case for (2) Model 55 Head Assemblies
DLT70PYCC1501	Case for (1) Model 70 Power Unit
DLT70PYCC1502	Case for (2) Model 70 Head Assemblies
DLT70PYCC1503	Case for (1) Model 70 3" Head Assembly
DLT86PYCC0001	Case for (1) Model 86 Power Unit
DLT86PYCC0002	Case for (1) Model 86 Head Assembly
DLTXXPYSL0000	Swage Lube
DLT00HOSE0010	10' Hose Assembly comes with Quick Disconnects
DLT00HOSE0015	15' Hose Assembly comes with Quick Disconnects
DLT00SABP1040	Quick Disconnect Swivel Assembly for Model 10/20/40
DLT00SABP5570	Quick Disconnect Swivel Assembly for Model 55/70

## Spare Endplates and Bolts

DLT10PYFU3704	Model 10 - Upper Out Endplate
DLT10PSEU4006	Model 10 - Upper In Endplate
DLT10PSFL4006	Model 10 - Lower Out Endplate
DLT10PSEL4006	Model 10 - Lower In Endplate
DLT20PYEU0000	Model 20 - Upper Endplate
DLT20PYEL0000	Model 20 - Lower Endplate
DLT40PYEU0000	Model 40 - 00' Series Upper Endplate
DLT40PYEL0000	Model 40 - 00' Series Lower Endplate
DLT40PYEU0002	Model 40 - 02' Series Upper Endplate
DLT40PYEL0002	Model 40 - 02' Series Lower Endplate
DLT55PYEU0001	Model 55 - Upper Endplate
DLT55PYEL0001	Model 55 - Lower Endplate
DLT70PYEU0001	Model 70 - 01' Series Upper Endplate
DLT70PYEL0001	Model 70 - 01' Series Lower Endplate
DLT70PYEU0002	Model 70 - 02' Series Upper Endplate
DLT70PYEL0002	Model 70 - 02' Series Lower Endplate
DLT86PYEP0001	Model 86 - Upper/Lower Endplate
10-24 x 3/8"	Flat Socket Cap Bolts for Model 20/40/55/70 Endplates
1/4-28 x 1/2"	Socket Cap Bolts for Model 86 Endplates

## Optional Safety Endplates and Handles

DLT40PSPA000	Model 40 - 00' Series Upper Safety Endplate Kit
DLT40PSPA0002	Model 40 - 02' Series Upper Safety Endplate Kit
DLT55PSPA0001	Model 55 - Series Upper Safety Endplate Kit
DLT70PSPA0001	Model 70 - 01' Series Upper Safety Endplate Kit
DLT70PSPA0002	Model 70 - 02' Series Upper Safety Endplate Kit
DLT00PHLA4055	Model 40/55 Handle Kit
DLT70PHLA0000	Model 70 Handle Kit
DLT40PHLA0000	Model 40 Handle K
DLT55PHLA0000	Model 55 Handle Kit
DLT70PHLA0000	Model 70 Handle Kit

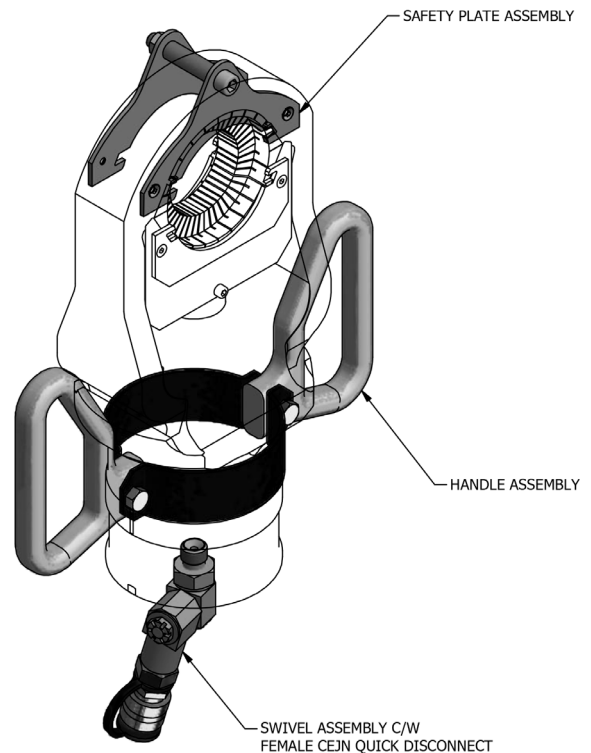

Introduction

Technical Information

DM 20 – NPS Pipe

DM 60 – OD Tube

DM 80 – Metric Tube

DM Series Thread Adapter

DM 80 – Metric & JIS Tube

DP 40N – NPS Low Pressure

DP 40M – Metric Low Pressure

PYPLOK® Tooling

Installation Procedures

Appendix



# Installation Procedures

## PYPLOK® Swaging Tool Parts and Equipment

Please see PYPLOK® Installation Manual for more in-depth information on installation procedures.

**WARNING**

**TOOL TO BE OPERATED BY QUALIFIED TRAINED PERSONNEL ONLY. REFER TO PYPLOK INSTALLATION MANUAL FOR PROPER OPERATING METHODS AND SAFE PRACTICES. DUE TO HIGH SWAGING FORCES, HEAD AND UPPER SECTION OF POWER UNIT MUST BE FULLY ENGAGED AND FLUSH ON BOTH SIDES. PARTIAL ENGAGEMENT MAY CAUSE TOOL FAILURE. SWIVEL AND QUICK CONNECT ASSEMBLY MUST BE INSTALLED PROPERLY BEFORE OPERATION OF PUMP. MAXIMUM ALLOWABLE OPERATING PRESSURE MUST NOT EXCEED 10,000 PSI / 690 BAR.**

**WARNING**

1. The PYPLOK® Tooling is intended for installing PYPLOK® Fittings in a safe and efficient manner. The operation of the tooling by means of an external hydraulic supply to crimp the PYPLOK® Fitting into place on matching tube or piping systems for a permanent, leak free, non-welded connection.
2. Select appropriate swage die set, apply swage lube to the bottom surface of the dies and landing areas of Lower Die Block and Head then insert (1) half of die set into lower die block and (1) half of die set into head. Attach endplates with bolts ensuring the tabs of the swage dies are located in the open slots of the endplates. Note that MSDS information for swage lube is available upon request and prolonged skin contact should be avoided although it is non-hazardous.
3. Check to ensure that the swage dies are located properly within the endplates and can move freely when pushed down.
4. Follow the above process when changing swage die sets for other sizes.
5. Used dies are to be inspected for debris and cleaned if required. Clean with pressurized air, soft brush or hand cloth removing all old swage lube and debris within the die slots and other surfaces.

Introduction

Technical Information

DM 20 – NPS Pipe

DM 60 – OD Tube

DM 80 – Metric Tube

DM Series Thread Adapter

DM80 – Metric JS Tube

DP 40N – NPS Low Pressure

DP 40M – Metric Low Pressure

PYPLOK® Tooling

Installation Procedures

Appendix

K1

# Installation Procedures

## Pipe Preparation

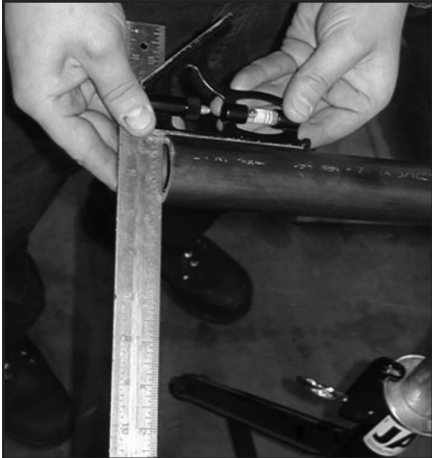

- Cut the pipe to desired length.
- Ensure that cut is square but up to 5° off square is acceptable.



- The pipe must be free of any scale, rust, paint, lacquer and any major scratches, gouges or weld seams.
- Use aluminum oxide cloth grit 80-400 or an abrasive wheel/tool to remove all debris from the pipe down to bare metal.
- It is important to note that all cleaning of the external pipe must only be done radially around the pipe and not longitudinally.
- Do not use a grinder or any other tool that will leave a rough, uneven or flat surface after cleaning.
- Do not use a wire wheel to attempt to remove lacquer.



- Deburr outside diameter of pipe with a file and the inside diameter with an internal deburring tool.
- It is critical to remove all sharp edges to prevent damage to the PYPLOK® fitting seals.

# Installation Procedures

## Pipe Preparation - Special Notice

### Carbon Steel Pipe With Surface Treatment

Special attention must be taken when using Carbon pipe with surface applications including lacquer, paint, galvanizing and other treatments. All surface treatments must be completely removed as per Pipe Preparation methods listed so that the sealing surface of the pipe is bare metal. If the sealing area is not cleared down to bare, smooth metal proper sealing of the PYPLOK® Fitting will be limited. Examples of improper pipe surfaces are found below:

#### Surface Not Cleaned

#### Lacquer Not Removed From Pipe

#### Surface Properly Cleaned/ Bare Metal Surface



### Gas Applications

Gases such as nitrogen are made of tiny molecules able to go through the smallest leak paths on pipe surfaces. Any foreign debris including surface treatments and or gouges/scratches can cause leaks. The most reliable connection is achieved when proper installation instructions are followed including very specific pipe surface preparation. Whenever possible, heavier pipe wall thickness should be used to offer a more reliable seal as the heavier wall will offer more resistance to the compressed fitting compared to thin wall. It may be required to pressure test a gas system to a much greater level than the operational pressure required. This will help set the pipe against the compressed fitting. Therefore, it is acceptable to pressure test the system to the maximum design pressure of the fittings or pipe (whichever is the lower value) in accordance with national and local regulations.

# Installation Procedures

## Verify Diameter of the Pipe Using the Inspection Gauge

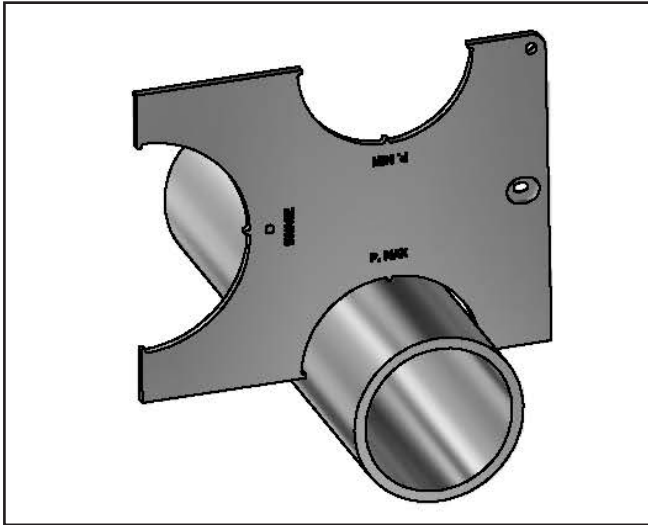

- P. Max gauge should fit 360° around the pipe. The area of the pipe to be inspected is the location where the fitting is intended to be installed.

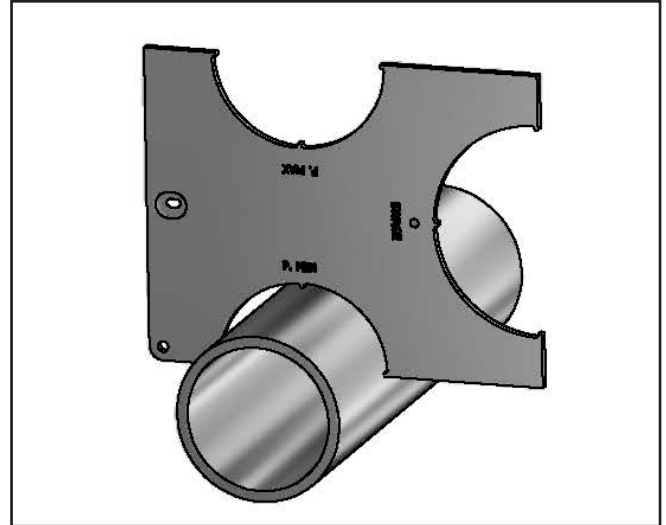

- P. Min gauge should not be able to fit at any point 360° around pipe. The area of the pipe to be inspected is the location where the fitting is intended to be installed.

**Note: If these criteria are not met, then a new location on the existing line that is acceptable must be used or the pipe cannot be used and new material is required. Pipe that does not meet the required dimension may not properly operate after crimping.**

## Pipe Marking

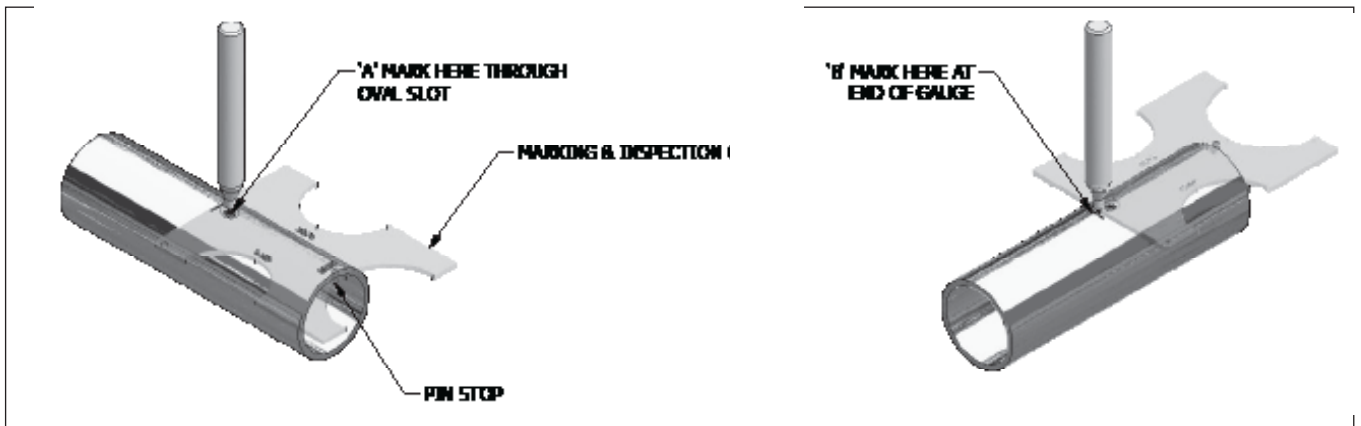

- Position the inspection gauge on the pipe with the pin stop pressed up against the pipe end as shown.

- Make the “A” oval mark on the pipe through the oval marking slot in gauge.

- Make the “B” line mark at the end of the gauge.

**Note: The minimum space between two fittings is 2x Pipe/Tube Diameter. This allows for the inspection gauge to fit between two connections for inspection and proper operation of the fitting. It must also be noted that no fitting can be installed within the radius of a bend and only straight pipe section can be used.**

# Installation Procedures

## Coupling Position and Alignment

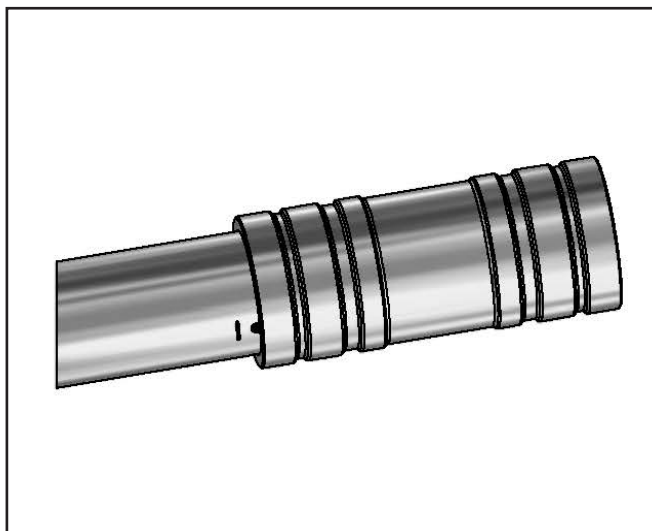

- Slide the coupling on to the end of pipe to first mark which is oval shaped.
- The edge of the coupling must touch any part of the oval mark.

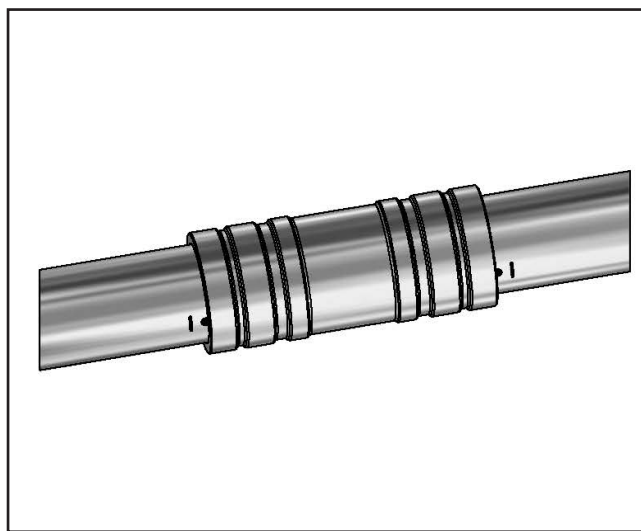

- Insert end of other pipe into coupling so the ends of pipe touch inside of the coupling.
- The markings should be visible as shown.

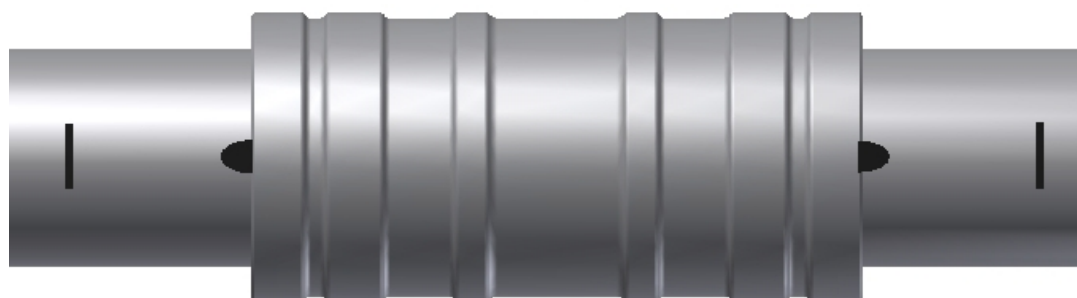

Introduction

Technical  
Information

DM 20 –  
NPS Pipe

DM 60 –  
OD Tube

DM 80 –  
Metric Tube

DM Series  
Thread Adapter

DM80 –  
Metric JS Tube

DP 40N –  
NPS Low  
Pressure

DP 40M –  
Metric Low  
Pressure

PYPLOK®  
Tooling

Installation  
Procedures

Appendix

K5



# Installation Procedures

## Swage Sequence

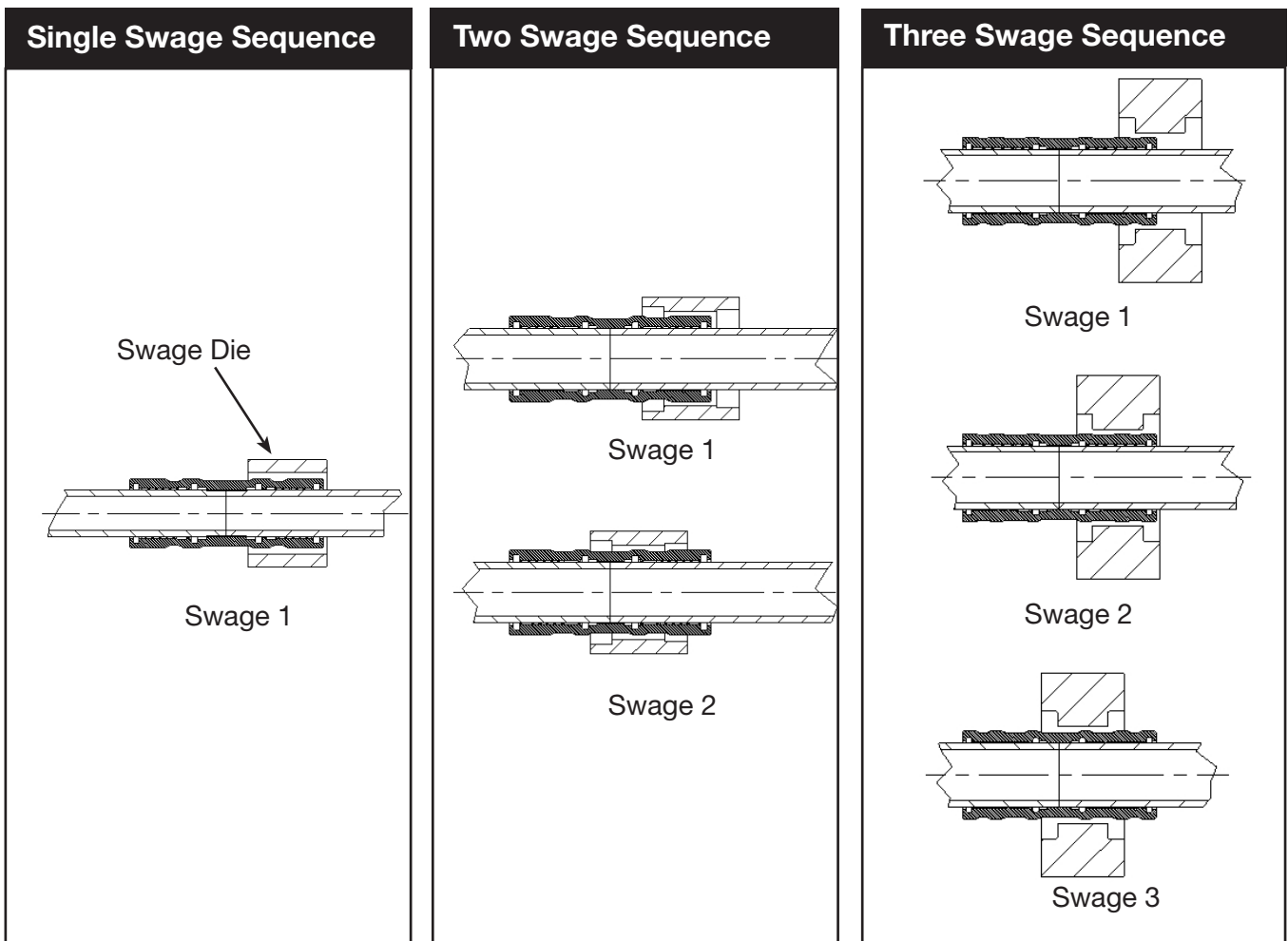

- All raised surfaces on coupling must be swaged.
- Swaging order is shown above for 1 swage, 2 swage and 3 swage configurations which varies by fitting size, series and tool model.
- Always start with the outside swage first and work towards the middle of the coupling.

**Note: For heavy wall pipe and duplex/super duplex fittings two swages maybe required per band. Swage at location, rotate PYPLOK® Tool 90° and swage again. This is only required if the inspection gauge does not pass over the swage band after original swage or for low pressure gas applications.**

# Installation Procedures

## Tool Operation and Die Engagement

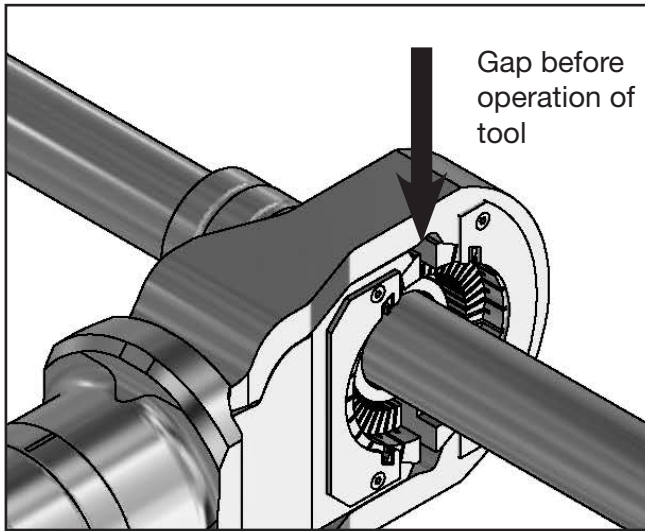

- Before swaging notice the gap between head assemblies.
  - The hydraulic power pack being electric, hand and or pneumatic are required to produce the required pressure and oil flow for the PYPLOK® Tool to operate.
  - Note that the PYPLOK® Tooling does not have noise emission >70dB(A).

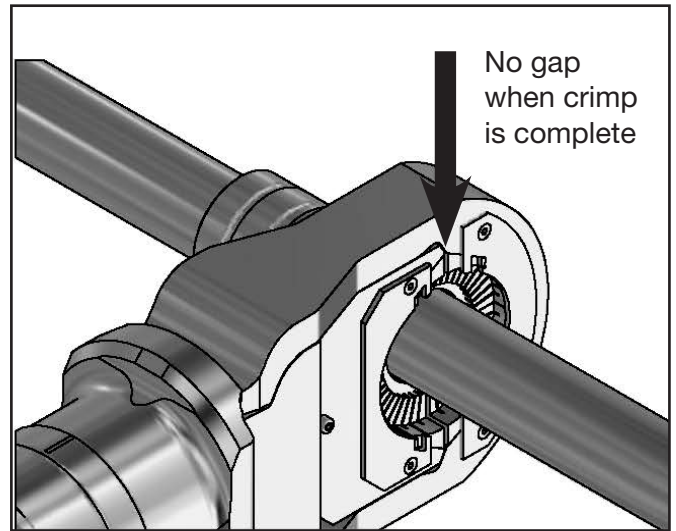

- To swage; turn on the power pack. The pressure from the power unit forces the lower die block and upper head assembly together thus swaging the fitting on the pipe or tube.
- The swage is complete when the head bottoms out and the gap closes.
- In cases where a pump with a 10,000 PSI/ 690 bar relief is available, the tool will stop crimping and retract once 10,000 PSI/ 690 bar is achieved.

# Installation Procedures

## Swage Inspection and Assembly

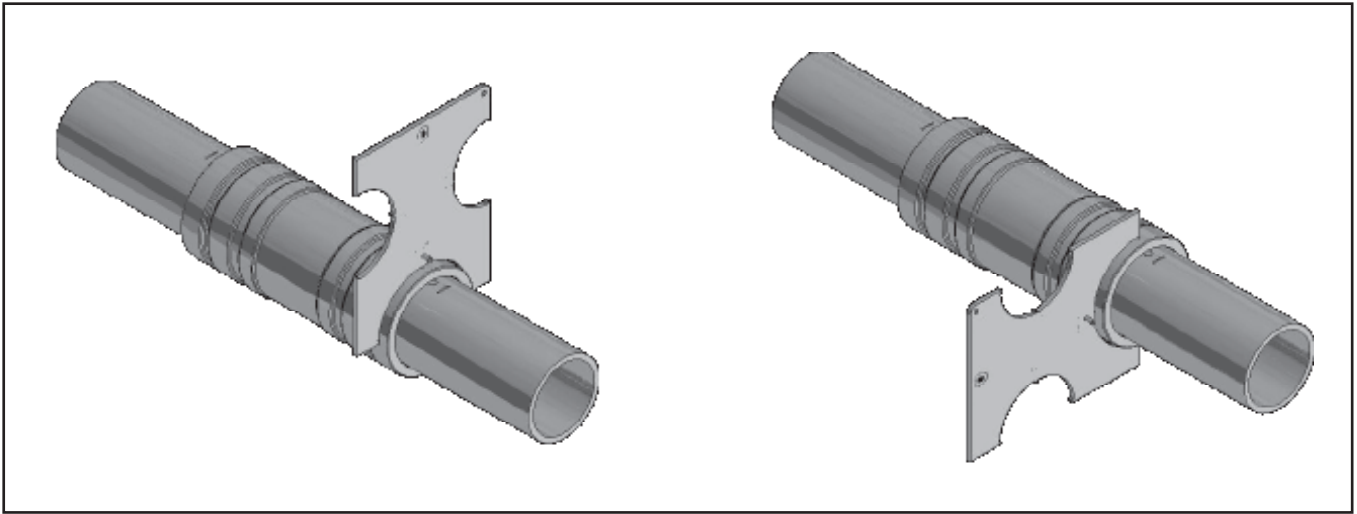

- Each swage band must be checked with the corresponding inspection gauge.
- The inspection gauge must fit freely around each swage band at two locations 90° from each other.

### Acceptable Crimp

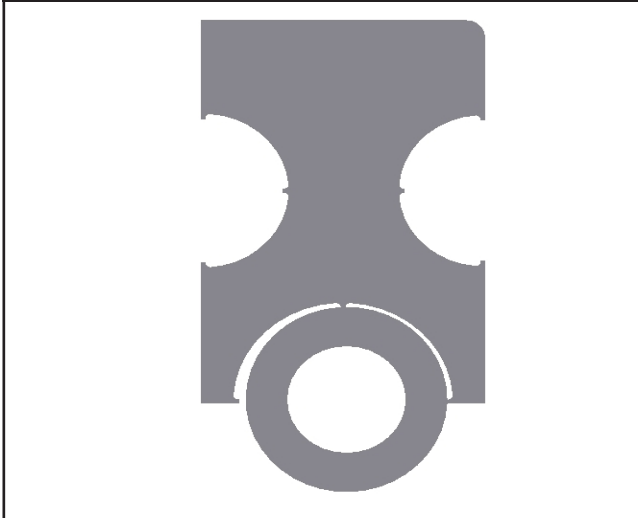

- 2 Point Contact, 90° Apart
- Acceptable Crimp

### Unacceptable Crimp

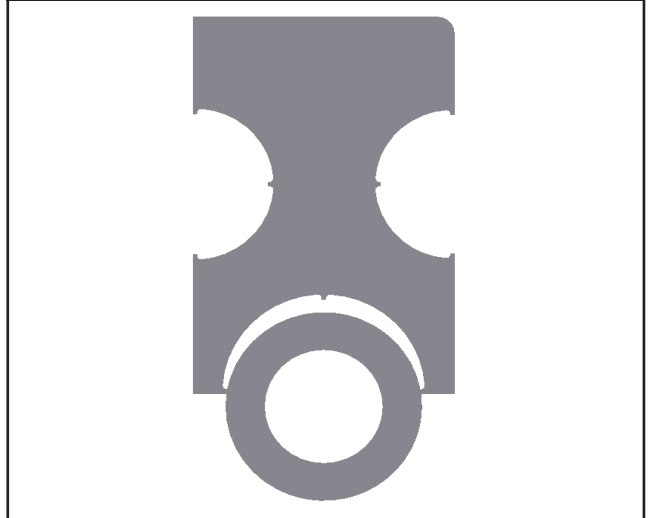

- 2 Point Contact, 180° Apart
- Indicates that diameter of fitting is oversized and need re-crimping

- If any area of the swage bands does not pass the inspection gauge the fitting must be re-swaged.
- It may be required to re-swage and then rotate the tool 90° and re-swage in certain situations.
- After re-swaging the fitting must be checked with the inspection gauge as per the above process.

# Installation Procedures

## Swage and Installation Inspection

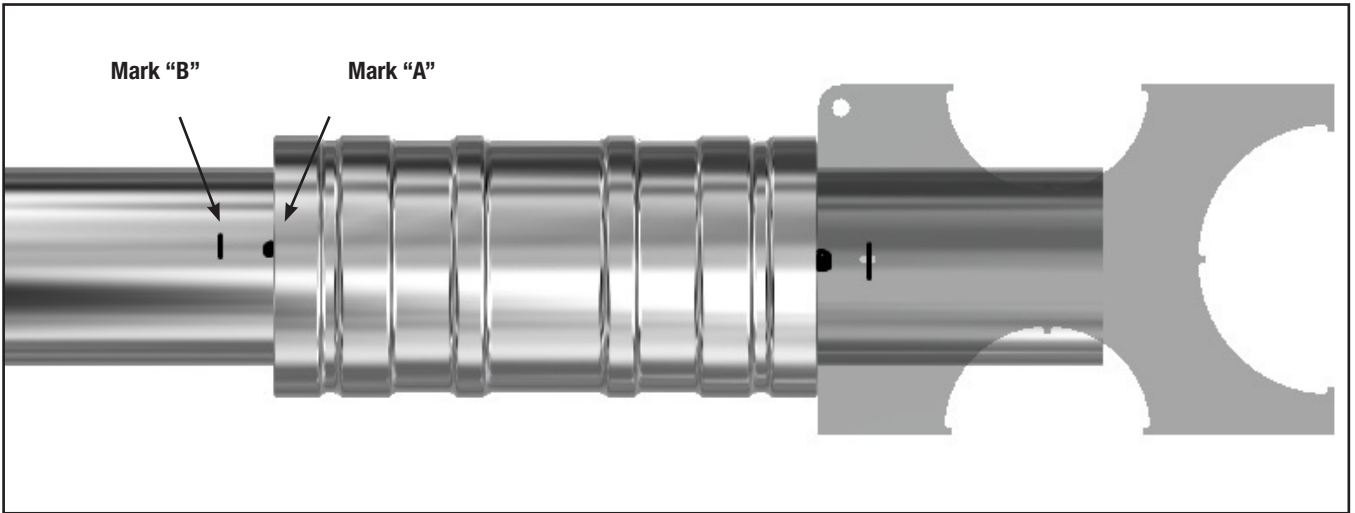

- Verify pipe insertion by observing that some portion of the pipe installation Mark "A" is beneath the fitting and that some portion of the mark is visible.
- In the event that the installation Mark "A" is not clearly visible, the inspection Mark "B" can be used to verify proper insertion.
- Position the marking tool against the fitting end, placing the side with the pin stop away from the pipe and verify that some portion of the inspection Mark "B" is visible in the gauge window or between the slot and the fitting end.

Introduction

Technical Information

DM 20 – NPS Pipe

DM 60 – OD Tube

DM 80 – Metric Tube

DM Series Thread Adapter

DM80 – Metric JS Tube

DP 40N – NPS Low Pressure

DP 40M – Metric Low Pressure

PYPLOK® Tooling

Installation Procedures

Appendix



# PYPLOK® Limited Warranty

**TUBE-MAC® PIPING TECHNOLOGIES LTD. WARRANTS ITS PRODUCTS TO BE FREE FROM VISIBLE DEFECTS IN MATERIALS AND WORKMANSHIP FOR A PERIOD OF ONE (1) YEAR FOLLOWING THE DATE OF DELIVERY TO THE ORIGINAL BUYER. THE WARRANTY EXTENDS ONLY TO THE ORIGINAL BUYER.**

TUBE-MAC® PIPING TECHNOLOGIES LTD. makes no warranty, express or implied, as to the merchantability or fitness for a particular purpose except as stated in this Warranty.

This Warranty shall be in lieu of any other Warranty, whether express or implied, by this Agreement or at law or in equity or by any statute or otherwise. The Buyer agrees that the foregoing shall be pleaded by TUBE-MAC® PIPING TECHNOLOGIES LTD. as an estoppel in any action brought by the Buyer against TUBE-MAC® PIPING TECHNOLOGIES LTD.

The Buyer agrees that porosity or pin holes in steel may not be commercially detectable. Therefore, TUBE-MAC® PIPING TECHNOLOGIES LTD. offers no warranty with respect to steel integrity and TUBE-MAC® PIPING TECHNOLOGIES LTD. shall not be liable for any damages, claims, injuries or otherwise caused by or in any way related to steel integrity.

TUBE-MAC® PIPING TECHNOLOGIES LTD. liability shall be limited to the repair or replacement of defective product(s) free of charge at the seller's sole option and discretion. TUBE-MAC® PIPING TECHNOLOGIES LTD. reserves the right at its sole option and discretion to refund a portion or all of the purchase price paid by the Buyer in lieu of any other obligations TUBE-MAC® PIPING TECHNOLOGIES LTD. has under this Warranty. In no event shall TUBE-MAC® PIPING TECHNOLOGIES LTD. be liable for any incidental, consequential, general or special damage of any kind or nature whatsoever including but not limited to loss of profit arising out of any incident(s) involving the use or utilization of the product and/or system covered under this Warranty. In no event shall TUBE-MAC® PIPING TECHNOLOGIES LTD. be liable for any personal injury or any special or general damages arising out of the personal injury of any kind or nature whatsoever.

TUBE-MAC® PIPING TECHNOLOGIES LTD. shall not be liable under this Warranty or otherwise if damages to the product are caused as a result of any type of accident or in the event the product and/or system was subject to alteration, abuse, misuse, extraordinary use of any kind whatsoever, improper maintenance or operation or improper or unauthorized repair.

TUBE-MAC® PIPING TECHNOLOGIES LTD. makes no warranty whatsoever as to any product and/or system covered by this Warranty which has been repaired or altered by anyone other than TUBE-MAC® PIPING TECHNOLOGIES LTD. or authorized personnel.

**TUBE-MAC® PIPING TECHNOLOGIES LTD. neither assumes nor authorizes any person to assume for it any other liability in connection with the sale of such products and/or systems.**

**WARNING: Failure or improper selection or improper use of the products and/or systems described herein or related items can cause death, personal injury and property damage.**

Introduction

Technical Information

DM 20 – NPS Pipe

DM 60 – OD Tube

DM 80 – Metric Tube

DM Series Thread Adapter

DM80 – Metric JIS Tube

DP 40N – NPS Low Pressure

DP 40M – Metric Low Pressure

PYPLOK® Tooling

Installation Procedures

Appendix

L1





## GLOBAL HEADQUARTERS

### **TUBE-MAC® PIPING TECHNOLOGIES LTD.**

853 Arvin Avenue  
Stoney Creek, Ontario  
L8E 5N8 Canada  
T. **+1 905.643.8823**

---

### **TUBE-MAC® INDUSTRIES INC.**

420 Halstead Blvd.  
Zelienople, Pennsylvania  
USA 16063  
T. **724.473.0823**

### **TUBE-MAC® INDUSTRIES (SERVICES) INC.**

5201 Orchard Road  
Pascagoula, Mississippi  
USA 39568  
T. **228.762.1732**

### **TUBE-MAC® PIPING TECHNOLOGIES, S.L.**

Avenida Sierra de Guadarrama, 14  
28691 Villanueva de la Cañada  
Madrid, Spain  
T. **+34 91 813 50 50**

### **TUBE-MAC® PIPING TECHNOLOGIES GMBH.**

Egon-Schiele-Str. 1  
A-4614 Marchtrenk Austria  
T. **+43 0 7243 51200**

---

**[info@pyplok.com](mailto:info@pyplok.com)**

**[pyplok.com](http://pyplok.com)**